

**DBPOWER**

PORTABLE VIDEO PLAYER QUICK USER GUIDE NS-958

# USER MANUAL

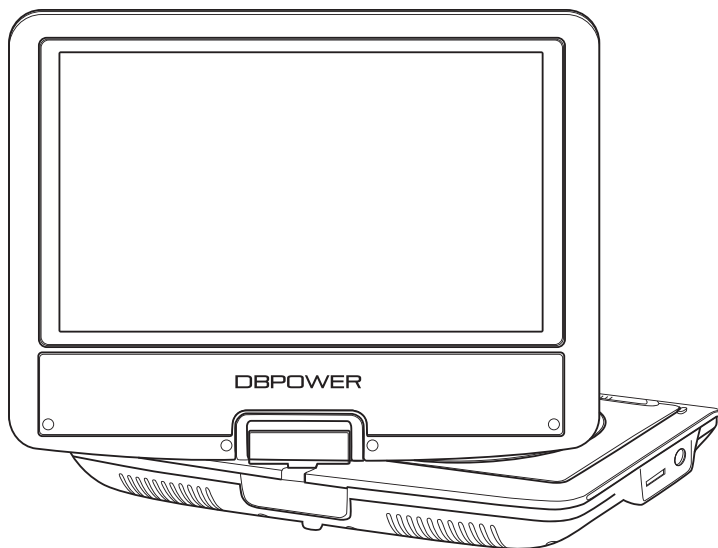

POWER YOUR LIFE

## **A BIG THANK YOU**

We're thrilled that you have chosen to purchase the Portable Video Player. At DBPOWER, we're committed to providing you with products that enhance your daily life. We also aim to give our customers excellent support. Should you have any questions or feedback about your new product, simply get in touch with our customer support team at 1-855-888-5533, or by email at [support@dbpowershop.com](mailto:support@dbpowershop.com)

Enjoy your new product!

 [support@dbpowershop.com](mailto:support@dbpowershop.com)

 1-855-888-5533



Federal Communications  
Commission Statement

## **IMPORTANT**

Since the CD Circuitry may cause interference to other radio tuners nearby, switch this unit off when not in use or move the affected radio tuner away.

This device complies with Part 15 of the FCC Rules. Operation is subject to the following two conditions:

1. This device may not cause harmful interference.
2. This device must accept any interference received, including interference that may cause undesirable operation.

This device complies with Canadian ICES-003  
Standard TELEVISION receiving Apparatus

## **FEDERAL COMMUNICATIONS COMMISSION STATEMENT**

NOTE: This equipment has been tested and found to comply with the limits for a Radio Receiver, pursuant to part 15 of the FCC Rules. These limits are designed to provide reasonable protection against harmful interference in a residential installation. This equipment generates uses and can radiate radio frequency energy and, if not installed and used in accordance with the instructions, may cause harmful interference to radio communications. However, there is no guarantee that interference will not occur in a particular installation. If this equipment does cause harmful interference to radio or television reception, which can be determined by turning the equipment off and on, the user is encouraged to try to correct the interference by one or more of the following measures:

---

- Reorient or relocate the receiving antenna.
- Increase the separation between the equipment and receiver.
- Connect the equipment into an outlet on a circuit different from that to which the Receiver is connected.
- Consult the dealer or an experienced radio/ TV technician for help.

Caution: Changes or modifications no expressly approved by the party responsible for compliance could void the user's authority to operate the equipment.

---

## IMPORTANT SAFETY INSTRUCTIONS

When using electronic equipment, basic safety precautions should be followed.

### WARNING

To reduce the risk of electric shock, fire or injury to persons:

1. Read all instructions before using the unit.
  2. Use this unit only for its intended use as described in this manual.
  3. Do not operate this unit if it has a damaged cord or plug, is not working properly or has been damaged or dropped. If the supply cord is damaged, it must be replaced by the manufacturer or its service agent or a similarly qualified person in order to avoid a hazard.
  4. WARNING: Do not allow children to use the unit without supervision.
  5. WARNING: Liquids and foodstuffs must not be spilled or dropped into the unit.
  6. WARNING: It is hazardous for anyone other than a trained person to carry out any service or repair operation.
  7. This unit is not intended for use by persons (including children) with reduced physical, sensory or mental capabilities, or lack of experience and knowledge, unless they have been given supervision or instruction concerning use of the product by a person responsible for their safety.
  8. Children should be supervised to ensure that they do not improperly use the unit.
  9. Never leave the product powered on unsupervised. Switch off the product when it is not in use, even if this is only for a short while.
  10. The unit must be free-standing. It must not be placed in a cabinet.
  11. The temperature of adjacent surfaces may increase when the unit is in use.
  12. This unit is not intended to be operated by means of an external timer or separate remote control.
  13. If smoke is emitted, switch off and unplug the unit immediately.
-

14. **Cleaning:** Unplug this product from the wall outlet before cleaning. Do not use liquid cleaners or aerosol cleaners. Use a slightly dampened cloth for cleaning and immediately wipe dry.
  15. **Attachments:** Use only attachments recommended by the manufacturer. Use of other attachments may be hazardous.
  16. **Water and Moisture:** Do not use this product near water (e.g. near a bath tub, washbowl, kitchen sink, laundry tub, in wet basements, or near a swimming pool and the like).
  17. **Ventilation:** Slots and openings in the product casing are provided for ventilation to ensure reliable operation of the product and to protect it from overheating. These openings should never be blocked by placing the product on a bed, sofa, rug, or other similar surface. This product should not be placed in any enclosure such as a bookcase or rack unless proper ventilation is provided.
  18. This unit must not be exposed to dripping or splashing liquids and objects filled with liquids, such as vases, must not be placed on the apparatus.
  19. **Replacement Parts:** When replacement parts are required, be sure that your service technician has used replacement parts specified by the manufacturer or that have the same characteristics as the original part. Unauthorized substitutions may result in fire, electric shock, or other hazards.
  20. **Safety Check:** Upon completion of any service or repairs to this product, ask the service technician to perform safety checks to ensure that the product is in proper operating condition.
  21. **Overloading:** Do not overload wall outlets, extension cords, or any other power source as this may cause a fire or an electric shock.
  22. When the AC/DC adapter is used as the disconnect device, the disconnect device must remain readily operable. To completely disconnect the power input, the AC/DC adapter must be completely disconnected from the mains.
-

# CONTENTS

<b>FEATURES</b>	01
<b>PRECAUTIONS AND WARNINGS</b>	02
<b>PACKAGE CONTENTS</b>	05
<b>BUTTON INTRODUCTION</b>	06
Front/Rear Panel	06
Panel Keys	07
Remote Control Buttons	09
<b>REMOTR CONTROL</b>	11
<b>GENERAL SETUP</b>	12
<b>MENU OPERATION</b>	13
General Setup Page	14
Audio Setup Page	15
Panel Quality Setup	15
Preference Page	15
<b>PLAYBACK</b>	17
<b>SPECIFICATIONS</b>	18
<b>TROUBLESHOOTING</b>	19
<b>WARRANTY EXCLUSIONS</b>	21
<b>FAQ</b>	22

Please read this manual in its entirety before making connecting and operating your unit. Please retain this manual for future reference. This unit is small, lightweight and utilizes the latest state-of-the-art electronics. It is easy to install, conveniently portable and may be used at home, in the office, or on holiday.

## **FEATURES**

High-definition TFT LCD screen Headphone jack

USB/SD Card slot

Compatible with DVD/VCD/CD disc etc.

Playback controls include: Play/Pause/Fast-forward Rewind

Operating voltage: DC 12V



## **PRECAUTIONS AND WARNINGS**

### **1. PLACEMENT:**

- To prevent fire or shock hazards, do not expose this appliance to rain or moisture.
- Do not expose this appliance to direct sunlight.
- Keep this appliance away from strong magnets, heat sources and excessive dust.
- Do not place this appliance on an unstable surface.
- If the unit is brought directly from a cold place to a warm one, moisture may condense inside the unit and cause a malfunction. If this occurs, leave the unit turned on for a few hours until the moisture evaporates.

### **2. INSTALLATION:**

Ensure that the portable DVD player is installed according to the instructions and illustrations provided in this manual.

### **3. CAUTION:**

- Do not drop or insert any objects into the unit through the openings.
- Do not spill or spray liquid of any kind on or in the unit (this may result in a fire or electric shock).
- Do not place anything heavy on the unit.
- To ensure proper ventilation and operation, never cover or block the slots and openings with cloth or other materials.
- Keep the unit away from open flames such as fire or candles etc.

Install the batteries correctly as incorrect replacement is hazardous. Dispose of batteries in accordance with local regulations.

- The maximum operating temperature is 95 °F or 35 °C

#### **4. DISASSEMBLING PROHIBITED:**

Never attempt to disassemble the unit as this is very dangerous and may cause electric shock or harm from exposure to the laser beam. Please refer all servicing and maintenance to an authorized service centre.

#### **5. CLEANING UNIT:**

1. When cleaning, please make sure the unit is unplugged from the power source.
2. Do not use chemicals or detergents when cleaning.
3. Use a soft cloth lightly dampened with water to clean the exterior of the unit only and immediately wipe dry.

#### **6. DISC HANDLING:**

- Do not leave discs near heat sources, in direct sunlight, or in high humidity.
- Store discs in their cases when they are not being used.
- Stacking discs or standing them at an angle without putting them in the case can cause the disc to warp.
- Do not touch the disc surface when handling a disc, hold it by the edges.
- Fingerprints, dust, dirt or scratches on the disc can distort the picture or reduce sound quality.
- Always handle carefully and make sure discs are clean before use.  
Do not stick paper or tape to the disc.
- Do not write on the disc with a marker etc. Clean discs using a soft cloth, lightly wiping from the centre outwards.
- Do not use solvents such as benzene, commercially available cleaners not intended for CDs or anti-static spray intended for vinyl LPs, as these may damage your disc.

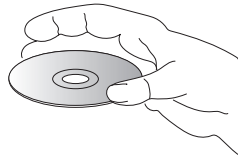
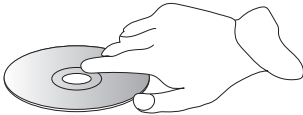
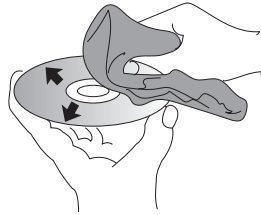
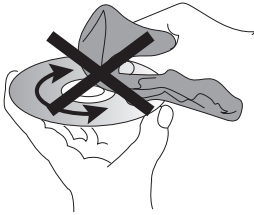

Cleaning and handing the disc

## **PACKAGE CONTENTS**

1. AC ADAPTOR
2. REMOTE CONTROL
3. AV CABLE
4. CAR ADAPTOR
5. INSTRUCTION MANUAL

# BUTTON INTRODUCTION

## Front/ Rear panel

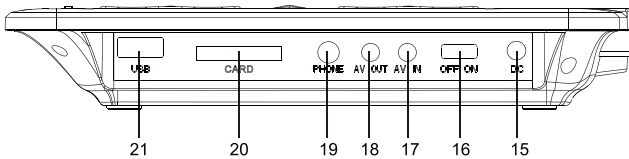
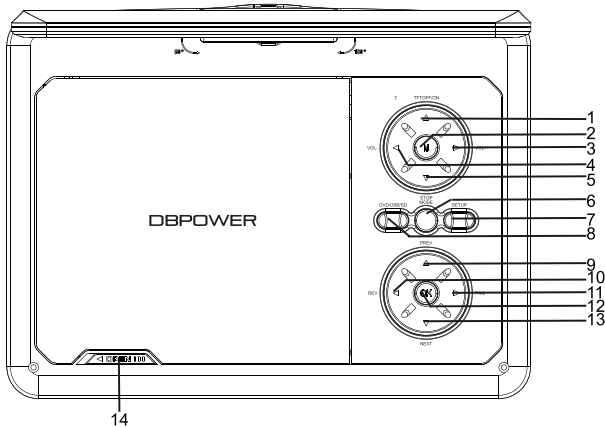

- |               |            |              |
|---------------|------------|--------------|
| 1. TFT OFF/ON | 10. REV    | 19. EARPHONE |
| 2. MENU       | 11. FWD    | 20. CARD     |
| 3. VOL+       | 12. OK     | 21. USB      |
| 4. VOL-       | 13. NEXT   |              |
| 5. STOP       | 14. OPEN   |              |
| 6. MODE       | 15. DC     |              |
| 7. SETUP      | 16. OFF/ON |              |
| 8. DVD/USB/SD | 17. AV IN  |              |
| 9. PREV       | 18. AV OUT |              |

## Panel keys

Common key functions on the panel:

### **STOP**

Press to stop current video.

### **TFT OFF**

Press to turn off the screen, press again to turn on the screen.

### **VOL-**

Press to decrease the volume

### **VOL+**

Press to increase the volume

### **MENU**

Press to return to the root menu

### **SETUP**

Press to enter the setup menu, then use the direction keys and OK to set the system menu.

### **MODE**

Press to switch to DVD or AV INPUT.

### **DVD/USB/SD**

Press repeatedly to switch input source: Disc/ USB mode/ SD card.

### **OPEN**

Press to open the door.

### **PREV**

Skip to the previous chapter/ track

### **NEXT**

Skip to next chapter/ track

### **FWD**

Press to achieve fast forward

### **REV**

Press to achieve rewind forward

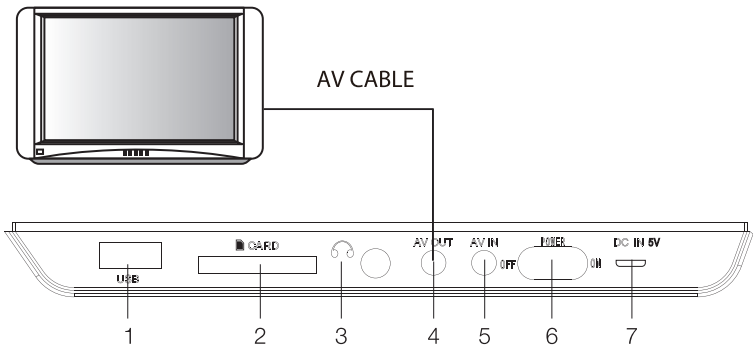

1. USB (USB Sticks, up to 32GB)
2. SD Card (up to 32GB)
3. 3.5mm Audio port
4. AV OUT
5. AV IN
6. Power Switch
7. Charging Port

## Remote control buttons

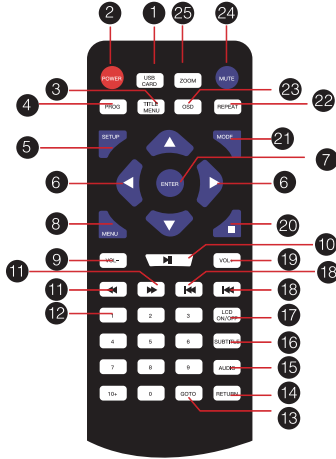

1. CARD/USB	14. RETURN
2. POWER	15. AUDIO
3. TITLE MENU	16. SUBTITLE
4. PROG	17. LCD NO/OFF
5. SETUP	18. PREV/NEXT
6. DIRECTION BUTTON	19. VOL+
7. ENTER	20. PAUSE
8. MENU	21. MODE
9. VOL-	22. REPEAT
10. PLAYER/PAUSE	23. OSD
11. FAST FORWARD/FAST REWIND	24. MUTE
12. 0-9 NUMBER KEYS	25. ZOOM
13. GOTO	



1. **CARD/USB:** Press the key to switch between DVD, CARD and USB modes.
2. **POWER:** Press to close the player screen.
3. **Title menu:** All program titles can be displayed.
4. **PROG:** Press to program a loaded disc to play chapters and titles or tracks in a Specified order.
5. **SETUP:** Press it to go to the Setup menu directly in any time (except the AV mode)
6. **DIRECTION BUTTON:** Use the direction button to select a position or value.
7. **ENTER:** Press to confirmation option.
8. **MENU:** Press to view the main menu on a loaded DVD.
9. **VOL-:** Press to decrease volume, minimum to 0
10. **PLAY/PAUSE:** Press to play or pause the audio/ movie playback.  
Confirms the selection or press it to select the file to play.
11. **Fast Forward/Fast Rewind:** Press to select the fast forward/ rewind speed.
12. **0-9 Number Keys:** Use the Numeric buttons to input a DVD chapter or DC track(invalid for some discs) and press PLAY/PAUSE button to confirm
13. **GOTO:** Press to choosing to start from a certain segment when playing audio and video. Press to a specific time index/title/chapter.
14. **RETURN:** During DVD play, press this key, to main menu.
15. **AUDIO:** Press to switch left and right channels.
16. **SUBTITLE:** Short press changes subtitle mode.
17. **LCD ON/OFF:** Press it and shut down the LCD screen.
18. **PREV/NEXT:** Press to play previous chapter/title/track. Press to play next chapter/title/track.
19. **VOL+:** Press to increase volume, maximum to 20.
20. **PAUSE:** Short press to stop the audio/video/phone playback.
21. **MODE:** Press to select "DVD" mode or "AV IN" mode.
22. **REPEAT:** Press repeatedly to cycle through repeat options for the loaded dis.
23. **OSD:** Press to display audio and video information such as title, play time, etc.
24. **MUTE:** Press key to mute the audio of the player. Press it again to activate the sound.
25. **ZOOM:** For the DVD disc, short press to access the zoom function.  
You can select the 2X, 3X, 4x, 1/2, 1/3.

## REMOTR CONTROL

- Unscrew and remove battery cover.
- Properly dispose of any exhausted batteries.
- Insert 2 new AAA batteries.
- Be sure the positive (+) and negative (-) ends of the batteries are properly oriented.
- Replace the battery cover.
- Do not mix old and new batteries.
- Do not mix alkaline, standard (carbon-zinc) or rechargeable (nickel-cadmium) batteries.

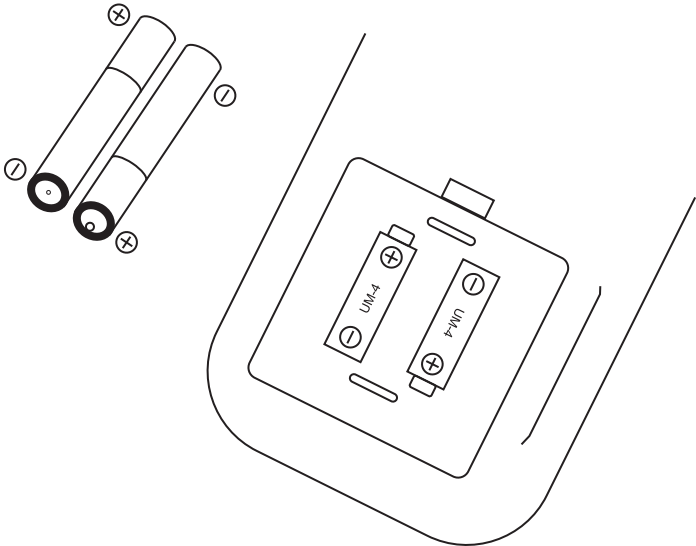

## **GENERAL SETUP**

### **1. Charging the unit**

This player is powered by a lithium-polymer battery. It features a high energy to weight ratio. It can be recharged at any time, regardless of whether it is fully or partially discharged. It takes about 4 hours to fully charge the battery and a fully charged battery can be used for up to 4 hours.

Connect the attached AC/DC adaptor to the DC INPUT jack on the unit, then plug the adaptor into a AC outlet.

Note: Make sure you switch off the unit before charging. The charging indicator LED will change from RED to GREEN to indicate that the battery has been fully charged.

### **2. Usage and maintenance of the battery**

1. The operating temperature of the rechargeable battery ranges from 41-104 °F .
2. Always unplug the unit when it is not being used unless it is being charged.
3. Heat is inevitably produced during playback, this is normal. However, switch off the and allow it to cool down.
4. Do not subject the battery to force and keep it away from heat and moisture.

### **3. Connecting to the TV**

This unit can be connected to a TV in order to enjoy high-quality music, movies etc with a TV.

Use an AV cable to connect the AV OUT jack on the unit to the AV IN jack of a TV.

DVD player has sound and video input jacks for connecting external audio and video inputs.

## **MENU OPERATION**

1. Press [SETUP] on the remote control or on the unit to show the setup menu.
2. Press [LEFT]/[RIGHT] to select an item. The submenu of the selected item will be instantly shown.
3. Press [UP]/[DOWN] to select an item in the submenu, then press [OK]/[ENTER]/[RIGHT] to enter. Use [UP]/[DOWN] to select an option, then press [OK]/[ENTER] to confirm or press [LEFT] to cancel,
4. Press [UP]/[DOWN] to scroll to other items in a submenu.
5. Press [LEFT] to go back to the superior menu of the current one.
6. Press [SETUP] again and press [ENTER]/[OK] to exit the setup menu.

## General Setup Page

There are six items in the GENERAL SETUP PAGE. They are TV Display, Angle Mark, OSD Language, Screen Saver, Last Memory and MP3 Lyric.

### TV DISPLAY

This function can adjust the proportion of TV screen after connecting to TV.

#### Normal/ PS

Normal PS means that the 16:9 image is cropped out of the visible portion to fit the 4:3 screen display.

#### Normal/ LB

Normal LB means that the 16:9 aspect ratio is displayed on a 4:3 screen

#### Wide

Wide means wide screen mode.

### ANGLE MARK

Set this item to ON. When a disc encoded with multiple camera angles is playing, the angle mark will display on the screen. Then you can view the video of different camera angles by pressing [ANGLE] on the remote control. Set this item to OFF to disable this function.

#### NOTE:

This function only works with those discs encoded with multiple camera angles.

### OSD (on-screen display) language

Set this on-screen display language in this item.

### SCREEN SAVER

ON: If the image remains motionless on the screen, for example the disc is paused, stopped etc, for several minutes, a screen saver will appear on the screen. You can press any key or button to wake it up.

OFF: Disable the screen saver function.

### LAST MEMORY

ON: Each time you turn off the unit or stop the disc, it will memorize the last play time. Next time you turn on the unit and play the same disc, the unit will play from that memorized point.

OFF: Disable the last memory function.

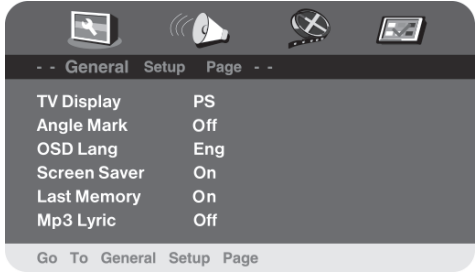

## MP3 Lyric: Set MP3 Lyric Mode on or off.

If you want to show the lyrics of a song, please load the lyrics and the music as the same name in the USB or Memory card before performing this function. Choose MP3 file, for example 'love music. mp3'. Download the corresponding lyrics with extension 'lrc' from the Internet or create it with lyric file editor(not included). Rename the lyrics file. Make sure that the lyrics filename is the same as the music file name. For example 'love music. lrc'.

## Audio Setup Page

Set speaker and sound field effects.

### Downmix

FULL 3/4 1/2 1/4 OFF

### Dual Mono

Stereo/ L-Mono/ R-Mono/  
Mix-Mono

### Dynamic

FULL 3/4 1/2 1/4 OFF

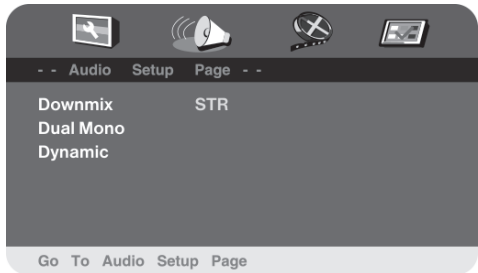

## Panel Quality Setup

The video menu allows you to change the display properties of the DVD.

### Quality

Sharpness: Adjusts the screen sharpness between LOW/ MID/ HIGH

Brightness: Adjusts the screen brightness

Contrast: Adjusts the screen contrast

Saturation: Adjusts the screen saturation

Hue: Adjusts the screen hue

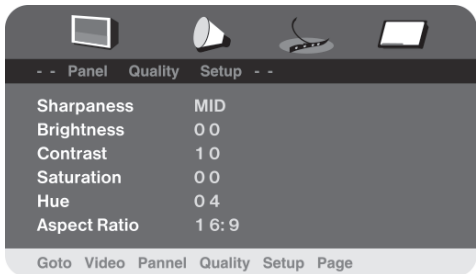

## Panel Display

Setup panel display to 16:9 or 4:3

## Preference Page

The preference menu option allows you to adjust the default DVD disc setting.(The setting is only available when no media is inside the unit.)

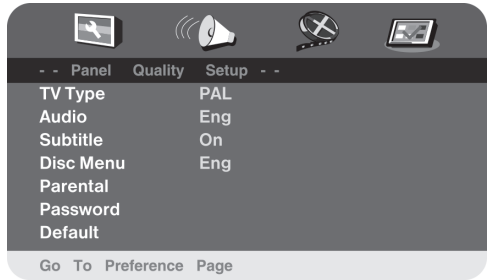

### TV Type

Set TV Type to PAL, AUTO, or NTSC

### Audio

Set the default audio language.

### Subtitle

Set the subtitle language

### Disc Menu

Set the disc menu language

### Parental

Set a maximum rating for discs that can be played without a password

### Password

Set a parental lock password (The default password is 0000)

### Default

Return the portable DVD to factory default beyond the maximum output of the speaker in sound effects processing.

## **PLAYBACK**

After all the connections are correctly made, switch on the unit.

### **Loading and Playing a Disc**

1. After connecting the unit to power, set the power switch to the ON position.
2. Push [OPEN] to open the disc tray. Place a disc in it with the label side facing up.
3. Close the disc tray. The unit will load the disc and start playing.

### **MP3/MPEG4 Disc Playback**

After the unit loads an MP3/MPEG4 disc, a menu showing the contents of the disc will display on the screen.

1. Press the direction key [UP]/[DOWN] to select a file or a folder.
2. Press [OK] to enter the selected folder. The files/ folders within it will be listed.
3. Press [OK] to begin playing the selected file.
4. When the disc is stopped press [LEFT] to return to the previous menu.
5. Close the disc tray. The unit will load the disc and start playing.

### **USB/ SD Playback**

Insert a USB/ SD drive into the USB/ SD port.

Press [DVD/ USB] to select UBS/ SD mode to play the readable files from the source.



## SPECIFICATIONS

Compatible DISC	CD-R, CD-RW, VCD, SVDC, CVD, DVD-R, DVD+R, DVD-RW, DVD+RW
Audio format	MP3/WMA (Bit rates: 32-192kbps)
Video format	AVI/MPG/DAT/VOB (Resolution must be within 720*576)
Picture format	JPG
E-book format	TXT
Frequency response	20HZ to 20KHZ
Video output	1 Vp-p75 Ohm unbalanced
Audio output	1.4V Rms/ 10K Ohm
Dynamic range	Better than 85dB
Laser	Semi-conductor laser, Wavelength:650
Power source	12V 1A
Operating temperature	41-104 ℉
Battery type	Li-polymer

## TROUBLESHOOTING

Before resorting to a professional maintenance service, please check the following chart.

SYMPTOM	SOLUTION
No sound or distorted sound	Make sure your DVD player is connected properly and all cables are securely inserted into the appropriate slots/jacks.
Cannot advance through a movie	You cannot advance through the opening credits and warning information that appears at the beginning of movies because the disc is programmed to prohibit that action.
The icon  appears on screen	<p>The feature or action cannot be completed at this time because:</p> <ol style="list-style-type: none"> <li>1.The disc software restricts it.</li> <li>2.The disc software does not support the feature.</li> <li>3.The feature is not available at the moment.</li> </ol>
Picture is distorted	The disc might be damaged. Try another disc. It is normal for some distortion to appear during forward or rewind scan.

<b>SYMPTOM</b>	<b>SOLUTION</b>
No forward or rewind scan	Some discs have a feature that prohibits rapid scanning or title and chapter skip. The movie is often programmed to prohibit skipping through the warning information and the credits at the beginning of a movie.
The player stops working when a USB drive or memory card is inserted into the player	This phenomenon may occur for the following reasons: <ol style="list-style-type: none"><li>1.Drive/card or USB interface is damaged.</li><li>2.Drive/card is not inserted.</li><li>3.File format is NTFS.(Must be FAT32)</li></ol> Please confirm if it is one of the above 3 reasons. If you are unsure, please contact customer service at support@dbpowershop.com

## WARRANTY EXCLUSIONS

The warranty will be void if:

- 1.The product has not been installed, operated or maintained in accordance with the manufacturer's operating instructions provided with the product.
- 2.The product has been used for purposes other than its intended function.
- 3.The product has been used for purposes other than household use.
- 4.The damage or malfunction of the product is caused by any of following conditions:
  - Incorrect voltage
  - Accidents(including liquid or moisture damage)
  - Misuse or abuse of the product
  - Faulty or improper installation
  - Electricity supply problems including power surges or lightning damage.
  - Infestation by insects
  - Tampering or modification of the product by persons other than authorized service personnel.
  - Exposure to abnormally corrosive materials
  - Insertion of foreign objects into the unit
  - Use with unapproved accessories.

## FAQ:

1. Why can't the player be turned on?

Please make sure the switch on the right is set in the ON position. When the power is low, the unit will be unable to turn on. At this time, it is recommended that you use the original adapter to fully charge the DVD player, then attempt to turn it on.

2. Why does my player only turn on when plugged in ?

The main reason for this is that DVD player has not been used for a long time and the battery has not been charged or discharged properly. If the product is under warranty, please contact customer service by email.

3. Why is the player not reading my disc?

The portable DVD player does not support Blu-ray discs. Please ensure the lens of the disc player is clean and avoid touching it to prevent disc reading malfunctions.

4. Why can't the player read CD-RWs and DVD-RWs?

CD-RWs or DVD-RWs may become damaged after multiple writes and rewrites, meaning the DVD player may not be able to read the disc.

5. Why can't the player play video?

The maximum playable resolution is 720\*576. If the resolution of video files on the USB drive/SD card is higher than 720\*576, the player will not be able to recognize the file. This may result in abnormal playback, such as audio without image or no audio or image. To solve this problem, please use conversion software to convert the resolution of video files to 720\*576. For burned discs, you can convert the video resolution to 720\*576 using video conversion software on a computer, then burn it to the disc again.

6.How to properly charge the portable DVD player with the car charger?

Before charging the DVD player with the car charger, make sure that the output voltage of the cigarette lighter is 12V. The car charger cable cannot be used with the cigarette lighter other than 12V. For the output voltage value of the cigarette lighter, please refer to the vehicle's user manual or consult the car dealer.

7.How to extend battery life and battery endurance?

When you have received the portable DVD player, please fully charge the DVD with the original adapter before use. Afterwards, charge it at least once a month even during long periods of disuse. This will extend battery life and endurance.

Please refer to and heed all warnings and precautions in this user manual. We provide all our portable DVD players with a 12-MONTH warranty from the date of purchase.

Should you experience any problems not covered by the FAQs, please don't hesitate to email us at support@dbpowershop.com

We offer professional solutions to any problems you may encounter or in the case of issues covered under warranty, a direct replacement or refund without delay.



# DBPOWER

✉ [support@dbpowershop.com](mailto:support@dbpowershop.com)

☎ 1-855-888-5533



Made in China