

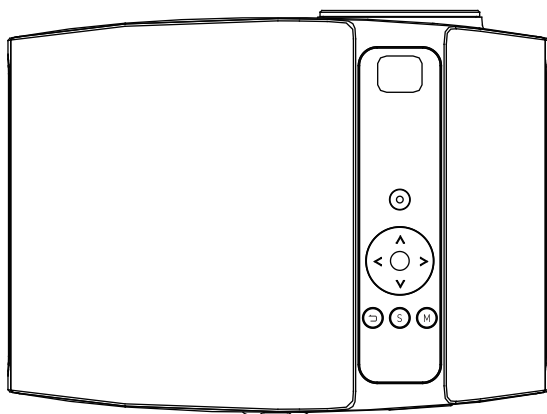

BL-69 MINI LCD VIDEO PROJECTOR

USER MANUAL



BEYOND ELEGANCE

(English)
CONTENTS

NOTICE	02
ACCESSORY LIST	03
SAFETY PRECAUTIONS	04
REMOTE CONTROL	05
PROJECTOR OVERVIEW	06
OPTICAL ADJUSTMENTS	11
CONNECTIONS	12
MENU SETTINGS	18
SCREEN MIRRORING	20
PROJECTOR INSTALLATION	27
TECHNICAL SPECIFICATIONS	28

Notice

1. Not recommended for PPT, Excel, Word presentations.
2. Change your PC/laptop screen resolution to 1280*720 for the best clarity.
3. Please note that it is suitable for use only in a totally dark environment.
4. Dolby Audio is NOT supported.

FCC Statement

This device complies with part 15 of the FCC rules. Operation is subject to the following two conditions: (1) this device may not cause harmful interference, and (2) this device must accept any interference received, including interference that may cause undesired operation.

The manufacturer is not responsible for any radio or interference caused by unauthorized modifications or change to this equipment. Such modifications or change could void the user's authority to operate the equipment.

This equipment has been tested and found to comply with the limits for a Class B digital device, pursuant to part 15 of the FCC Rules. These limits are designed to provide reasonable protection against harmful interference in a residential installation. This equipment generates uses and can radiate radio frequency energy and, if not installed and used in accordance with the instructions, may cause harmful interference to radio communications. However, there is no guarantee that interference will not occur in a particular installation. If this equipment does cause harmful interference to radio or television reception, which can be determined by turning the equipment off and on, the user is encouraged to try to correct the interference by one or more of the following measures:

- Reorient or relocate the receiving antenna.
- Increase the separation between the equipment and receiver.
- Consult the dealer or an experienced radio/TV technician for help important announcement Important .
- Consult the dealer or an experienced radio/TV technician for help.

RF Warning statement:

The device has been evaluated to meet general RF exposure requirement. The device can be used in portable exposure condition without restriction.

Accessory list

- 1 x AV Signal Cable
- 1 x Remote Control (battery not included)
- 1 x HDMI Cable
- 1 x Power Cable
- 1 x User Manual
- 1 x Warranty Card
- 1 x Operation Guide
- 1 x Adjustable Screw

Safety Precautions

1. Please read the user manual carefully before using the projector.
2. Only use the power cord supplied with this product with an electrical socket that is earthed properly.
3. Please use the same power voltage as marked on the projector.
4. Please do not disassemble the projector by yourself, otherwise it will void your warranty.
5. Please do not look into the lens directly while the projector is turned on, it may cause damage to your eyes.
6. DO NOT block the air vents during the use.
7. Please keep the projector away from water or any other liquid as it is not waterproof.
8. Please do not put the projector in wet or moist conditions to prevent electric shock.
9. Please switch off and unplug the appliance when it is not in use for a long time.
10. Please use the original packaging foam or other anti-shock material when relocating the projector.
11. Please contact the MOOKA customer support team if you encounter any problem with the projector.
12. This mini projector is covered by the MOOKA 12-month warranty.
13. Please contact us if you want to know more about the warranty. (The frame, user manual, and packaging are not covered by the warranty)

REMOTE CONTROL

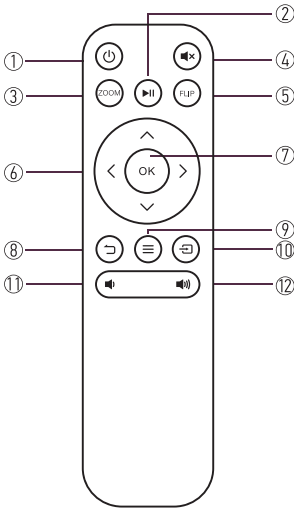

1. Power On/Off
2. Pause/Play
3. Zoom
4. Mute
5. Flip
6. Up/Down/Left/Right
7. Confirm
8. Return
9. Menu
10. Source
11. Volume -
12. Volume +

Caution

Do not submerge the remote control in water.

Do not expose the remote control to the outdoors, liquid, moisture, excessive heat, or fire.

Do not use old and new batteries together in the remote control.

Please take the batteries out if not using the remote control for a long time to avoid battery leakage.

The remote control must be held perpendicular to the projector's IR remote sensor to function correctly.

PROJECTOR OVERVIEW

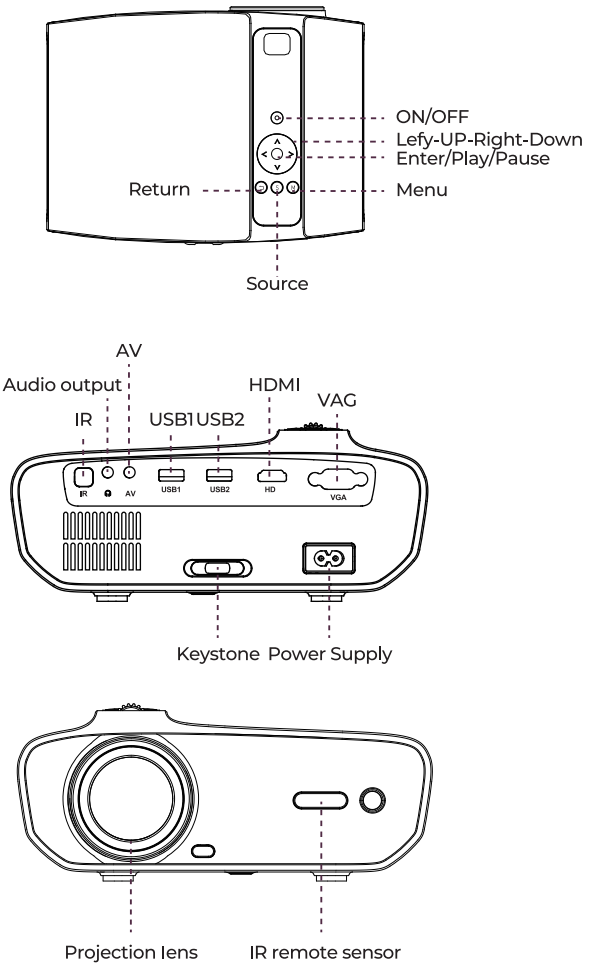

1. Connecting the projector to power

a. Plug the power cord to the projector.

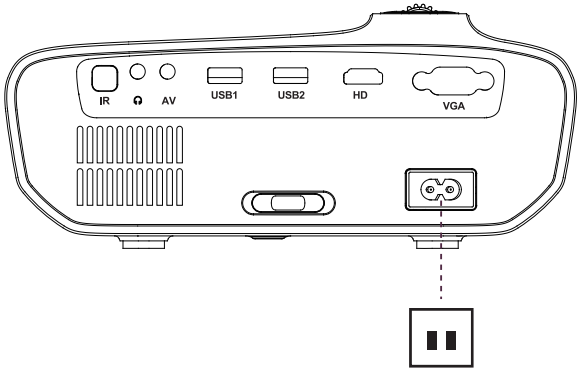

b. The power indicator on the projector lights up after the power cord has been connected.

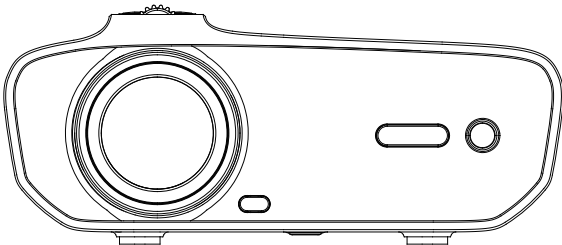

2. Power ON/OFF

Press the "⏻" button on the projector or on the remote control to power on.

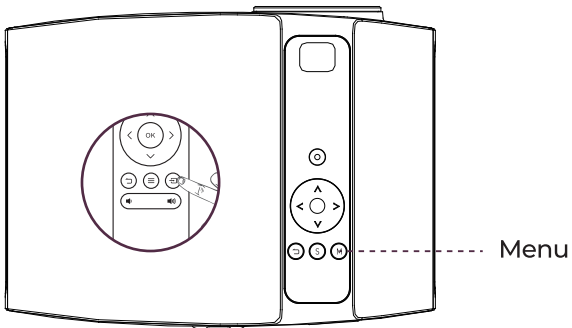
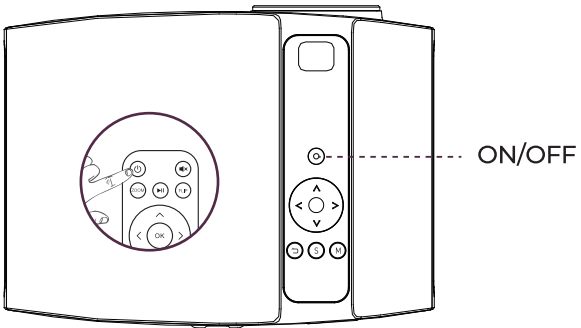

3.Multimedia boot screen

The multimedia screen will be displayed in 10-20 seconds after you press the power button.

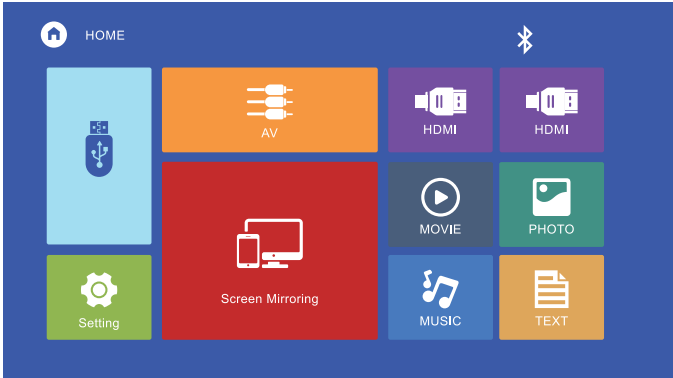

4. Focus & keystone correction

a. If the image is displayed as a trapezoid shape, turn the keystone correction knob on the upper surface of the projector until the projected image becomes rectangular to correct the keystone issue.

b. Make sure the projector is horizontal to the projector screen and rotate the focus ring to sharpen the projected image.

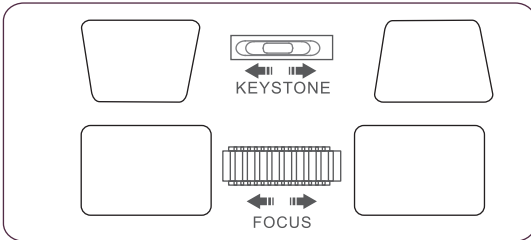
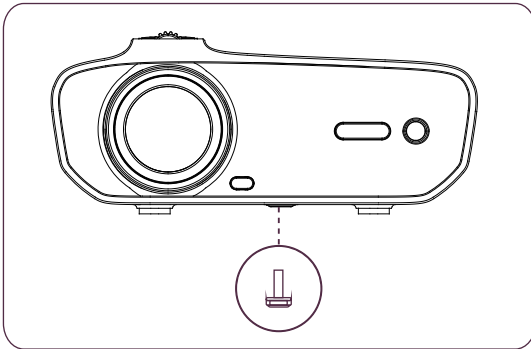

Optical adjustments

The projector corrects the image deformation by the optical keystone correction. See the example below:



However, this projector does not have a horizontal keystone correction function. The projector must be placed horizontally to the projection screen. If you encounter the problem as shown above, it is probably because the projector has not been placed horizontally to the projection screen, or the projection screen is not vertically positioned.

Solution: Adjust the projector's position so that it is horizontal to the projector screen

Connections

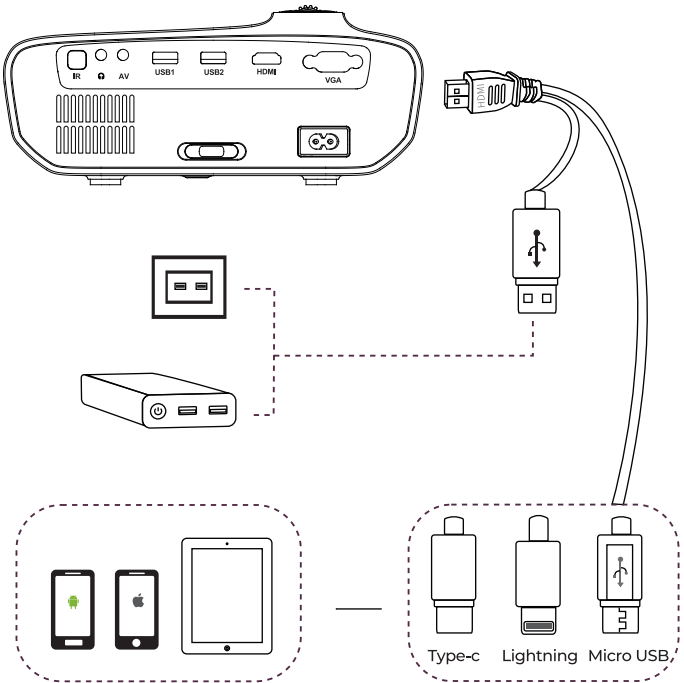

1. Playing media files from a USB Drive

a. Insert a USB storage device into a USB port.

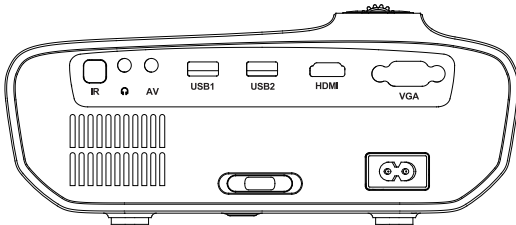

b. Pick USB at the Signal Sources menu.

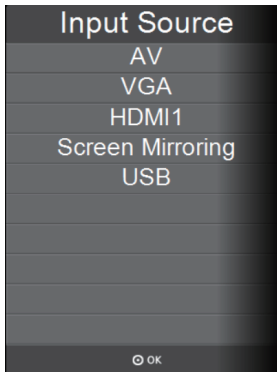

Supported multimedia file formats and types

Multimedia	Audio file	MP3/WMA/OGG/AAC/MA4/FLAC/APE/WAV
	Picture file	JPEG/BMP/PNG
	Video file	MPEG1, MPEG2, FLV, MPEG4, RM, AVI /RMVB, MOV, MKV, DIVX, FVOB M-JPEG (only unspported 640*480)
	Text file	TXT

c. Choose the content you need to display:

Video/ music/ photo/ text.

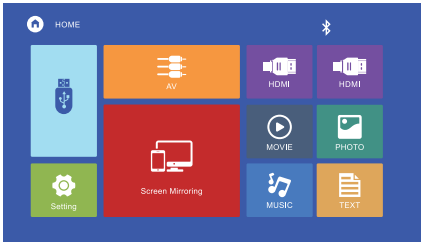

d. Choose the file you want to play. Press the " ▶| " key to play or to pause.

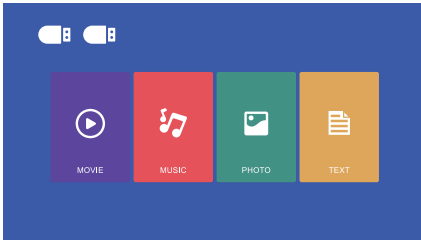

2. AV video connection

Use a 3-in-1 AV cable to connect to the projector as shown below. Once connected, pick AV at the Signal Sources menu.

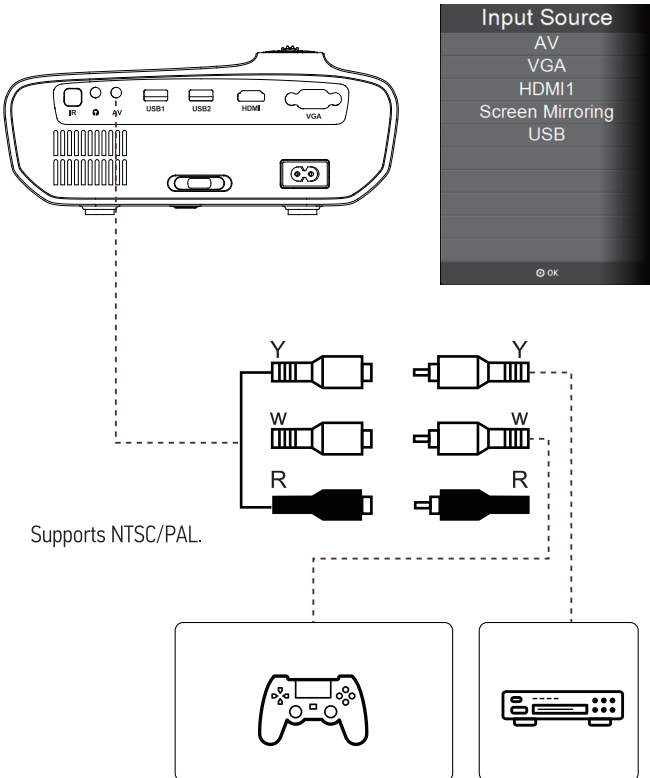

3. HDMI connection

Use the HDMI slot to connect computers and HDMI compatible devices. Once connected, pick HDMI1 at the Signal Sources menu.

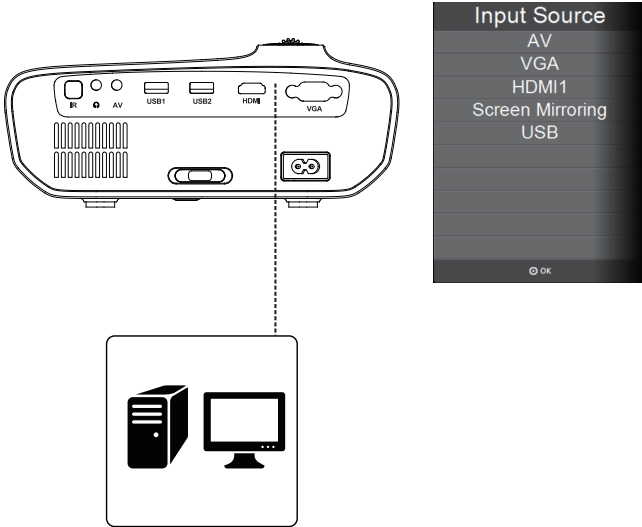

Supported resolutions:

576P, 480P, 720P, 1080P, 640x480, 800x600, 1024x768, 1280x1024, 1280x720, 1440x900, 1366x768, 1920x1080, 1280x800, 1440x960, 680x1050

4. 3.5mm audio connection

Use a 3.5mm audio jack to connect headphones/speakers.

Note: Dolby sound is not supported.

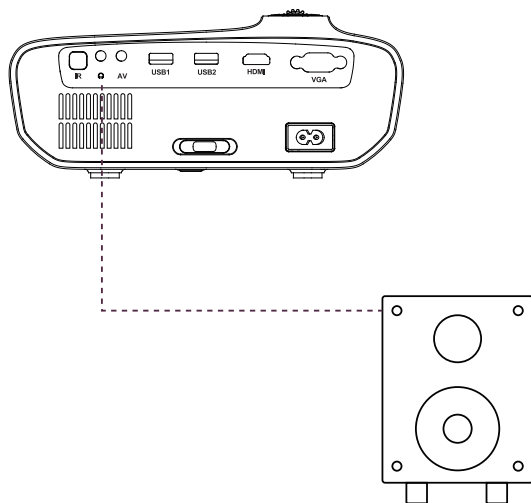

Menu settings

1. Remote control user guide

Press the “☰” key to enter the main menu, then press the “◀▶” key to enter each sub-menu.

Press the “▼▲” key to select the sub-menu, then adjust the parameters as required, and press the “OK” key to confirm.

2. Using the Sub-menu

The Sub-menu picture provided below is for reference only, and may differ from the actual design.

a. Available adjustments: Picture Mode/Color Temperature/Aspect Ratio/Noise Reduction/Screen/Projection Direct/HDMI Mode/Reduce Display

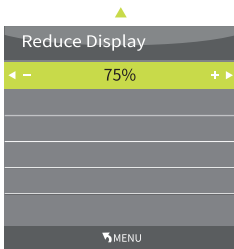
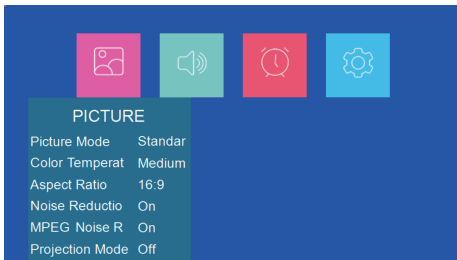

Zoom:

Adjust the size of the image using the Zoom function in the Reduce image sub-menu.

Zoom range: 75%-100%

(Note: This function is only valid in the video screen)

b. Sound sub-menu:

Available adjustments: Sound Mode/ Balance/ Auto Volume/ Volume/Bluetooth

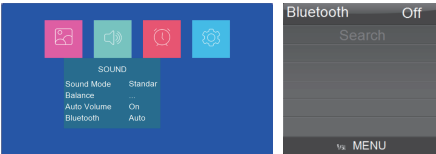

Turn on/off Bluetooth

When the Bluetooth is turned on, search for nearby Bluetooth speakers or earphones to pair the device.

Press the "OK" button to pair the device.

When the device is connected, press the "OK" button again to disconnect the device.

c. Settings sub-menu:

Timer shutdown: After selecting the timer shutdown duration in the menu, after the selected time is completed The machine will enter standby

Timer: The projector enters standby mode automatically when the set duration of the timer elapses.

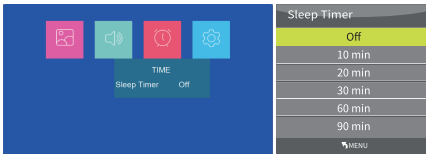

d. Settings sub-menu:

Timer: The projector enters standby mode automatically when the set duration of the timer elapses.

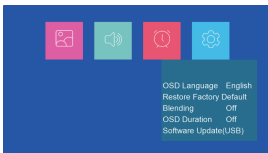

Timer shutdown: After selecting the timer shutdown duration in the menu, after the selected time is completed The machine will enter standby

e. Input Source sub-menu:

Available adjustments: AV/HDMI 1/Screen Mirroring/VGA/USB

Screen Mirroring

1. Select Screen Mirroring in the Input Source list
2. Press the OK key to enter the interface
3. Pick the appropriate variant (Figure 1)

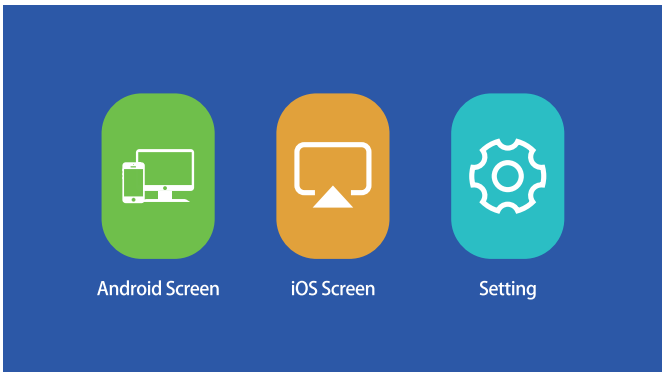
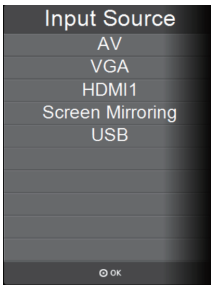

Figure 1

A. Android os

Android Screen has two connection methods.

Method 1: Wireless connection (Recommended)

1. Select Android Screen function



2. Turn on the WLAN on the Android device

3. Launch the Multi-screen / Wireless Display / Screen Mirroring / Smart View / Cast function (Figure1)

3. Select "MOOKA-XXXX" from the searching result list (Figure 2)

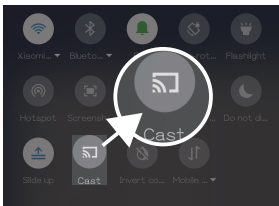

Figure 1

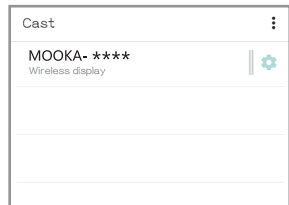

Figure 2

⚠ Some Android devices may not support screen mirroring due to the compatibility.

Method 2: Wired connection

1. Select Android Screen function.
2. On your Android device, find Developer options and turn on USB debugging.
3. Connect your Android device to the projector OUT5V port via the ORIGINAL USB cable.
4. For the first time, when the "Allow USB Debugging" window appears, select "Always allow from this computer" and tap "OK" to start screen mirroring.

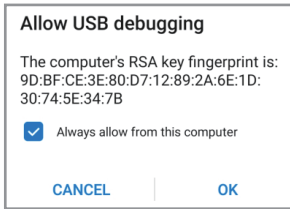

Figure 1

Tips:

USB debugging steps may vary due to different devices Android OS differences. Search for "How to open the USB debugging mode on "Your device" " in Google. Actual prompts are based on Samsung Galaxy S8+ OS.

1. Open the 'Settings', tap About->Software Information->Build number;
2. Tap "Build number" seven times until it shows Developer mode is turned on;
3. Go back to settings, scroll down and select 'Developer options';
4. Find the "Debugging" section;
5. Tap the toggle next to "USB Debugging".



1. Some Android devices may not support screen mirroring due to the compatibility. Such as: some models of Google/Motorola/Sony
2. Some Android devices may only transfer the display without audio due to the protocol restrictions.

B. iOS

iOS has 4 connection methods:

Method 1: Wireless connection with Wi-Fi router (Recommended)

1. Connect the projector to a Wi-Fi router;
2. Select iOS Screen Mirroring function;
3. Connect your iOS device to the same Wi-Fi router
4. Turn on Screen Mirroring on your iOS device, find the projector for pairing.



Method 2: Wireless connection without Wi-Fi router

1. You don't need to connect the projector to Wi-Fi router;
2. Select iOS Screen Mirroring function;
3. Turn on Wi-Fi on your iOS device and search for the network name of the projector (for example MOOKA-B09586);
4. Pick it and enter the password: 12345678. Your iOS device will connect to the projector automatically.
5. Turn on Screen Mirroring on your iOS device, find the projector for pairing.



Method 3: Streaming with your Wi-Fi router

1. Turn on the projector, select Screen Mirroring as the input source to enter the Screen Mirroring interface for iOS;



2. Open the 'Settings', connect your iOS device to the "LEISURE470-XXXXXX" Wi-Fi (pwd: 12345678);

3. Open the <http://192.168.49.1> webpage with the browser on your mobile device. Tap Wi-Fi AP > Scan, select your router's Wi-Fi and enter the appropriate password. Tap 'Connect' to continue;

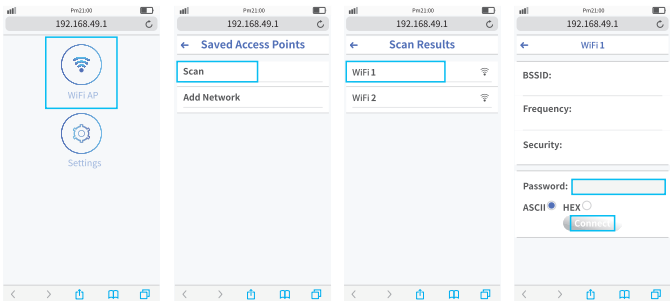

4. Your router's WiFi will be displayed on the Screen Mirroring interface for iOS after a successful connection;



5. Open the 'Settings', connect your iOS device to the same router's WiFi;

6. Turn on Screen Mirroring on your iOS device, find the projector (LEISURE470-XXXXXX) for pairing.



Tips:

If you'd like to connect to another Wi-Fi router, please repeat the above procedures.

Method 4: Wired connection

1. Select iOS Screen Mirroring function;
2. Connect your iOS device to the projector OUT5V port via the original USB cable.
3. Confirm the screen mirroring: when the "Trust this Computer?" window appears, tap "Trust" to start screen mirroring.

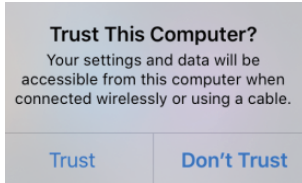

4. Confirm "Trust", then the screen mirroring will start

C.Setting

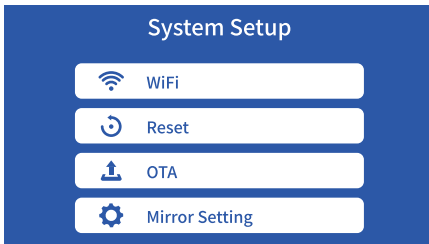

Description

WiFi: Connect to Wi-Fi router

Reset: Restore the Screen Mirroring function to its original system state

OTA: Online update

Mirror Setting: Mirror mode/Airplay mode

PROJECTOR INSTALLATION

Installation Method

The projector can be hung on the ceiling with special hanger frame, and placed on the stable desk to project the image according to the operating environment and requirement. In addition, the projector can be installed as following methods:

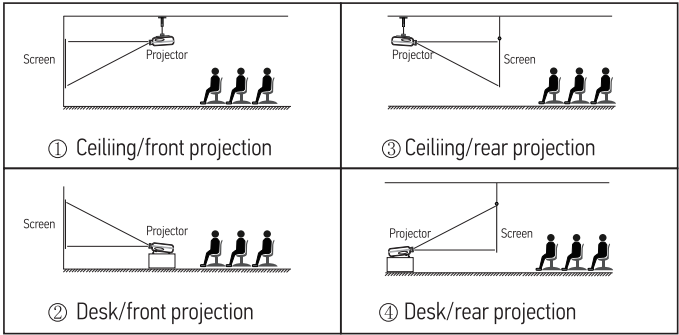

Install on the ceiling

- Contact a professional installer for the projector ceiling mounting;
- Please ensure that the screws used for ceiling mounting are of high quality and the length is enough to prevent the projector from falling;
- Please purchase an universal projector ceiling mount;
- Remove the four rubber pads on the bottom of the projector, you will see the screw holes and use the M5*11 mm screws for installing the ceiling, and then install it.

Warning:

- The projector may be damaged beyond repair if it is incorrectly mounted on a ceiling or on a surface.
- The recommended ambient temperature range is 41 °F - 95 °F. The incorrect temperature may lead to the device malfunction.
- Please do not place the projector in wet, moist, or dusty conditions to prevent electric shock or malfunction.
- Poor ventilation can be a significant cause of overheating. It could cause a projector to be damaged.
- Please use a coarse screw with a diameter of 1/4 inch and a thread of 20/inch to fix

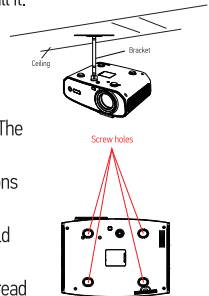

Throw distance and screen size

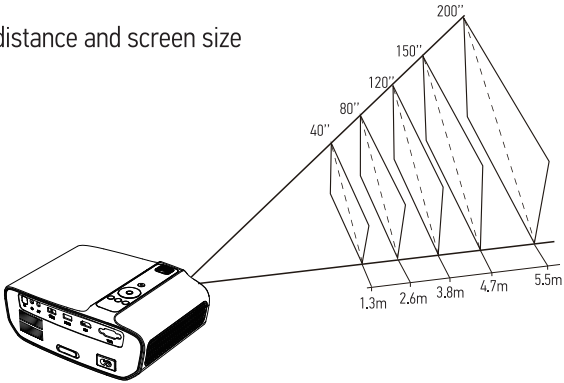

For reference only. Throw distance and screen size may vary due to different configurations.

Technical Specifications

Imaging Technology	LTPS LCD	Color Reproduction	16.7kk
Resolution	1920*1080	Keystone	Manual Correction $\pm 15^\circ$
Highest Resolution	1920*1080	Power Voltage	100V-240V 50/60Hz
Light	LED	Integrated watt	65W (Max)
Life Span	50,000 hrs	Input	USB/VGA/HDMI/AV
Lens	Multichip Coated	Output	Earphone USB(5V-500MA)
Operation Mode	Lens (F=135) Manual Operation	Speaker	5Ω 3W
		System support	Support multi-media
		Language support	Support 23 Language
Throw Distance	1.3-5.5M	Unit size	221*174.7*87.3mm
Screen Size	40-200 Inches	Projector Ratio	1.44:1
Aspect Ratio	4:3/16:9	Net Weight	1.42KG

ACTIVATE YOUR 12-MONTH WARRANTY

Register within 7 days after receiving your new product.

PLEASE VISIT US NOW

→ warranty.mookashops.com

CUSTOMER SERVICE

✉ support@mookashops.com 🌐 www.mookashops.com



NOTE

1. Only suitable for home entertainment in a dark environment. NOT for presentation purposes.
2. Dolby audio is NOT supported.
3. DO NOT obstruct the air vents when using. UNPLUG & PREVENT DUST from entering when not in use.

A Big Thank You

We're thrilled that you have chosen to purchase the Mini LCD Video Projector. At mooka, we're committed to providing you with products that enhance your daily life. We also aim to give our customers excellent support. Should you have any questions or feedback about your new product, simply get in touch with our customer support team at 1-855-666-9955, or by email at support@mookashops.com

Enjoy your new product!



Learn more about Mooka, please visit us at:

www.mookashops.com



or

Scan QR Code & Start Chatting



Made in China

FCC ID: 2AS7X-BL-69

m.me/mookashops

1-855-666-9955

support@mookashops.com

www.mookashops.com