

Model Number:

CBBIH3

CBBIH3B

CBBIH3BF



[www.ciarraappliances.com](http://www.ciarraappliances.com)





**Dear customer:**

Thank you so much for your purchase, please read this instruction manual carefully before installation & use.

If you have any question, please contact us at:

**E-mail:** [info@ciarraappliances.com](mailto:info@ciarraappliances.com)

# CONTENTS

<b>Signs and Symbols</b>	<b>3</b>
<b>Safety Instructions</b>	<b>4-6</b>
<b>Installation</b>	<b>7-11</b>
Important notes and installation requirements	7
Cutting the worktop	8
Ventilation and safety distances	9
Inserting the hob	10
Connecting the hob to the mains	11
<b>Product overview</b>	<b>12-14</b>
<b>Before use</b>	<b>15-16</b>
<b>Using the hob</b>	<b>17-26</b>
Starting to cook	17
Stop to cook	18
Power adjustment mode	19-20
The booster function	21-22
The flex zone function	23
Using the timer function	24-25
Safety	25-26
<b>Cooking guidelines</b>	<b>27</b>
<b>Cleaning the hob</b>	<b>28</b>
<b>Troubleshooting</b>	<b>29-30</b>
<b>Error codes</b>	<b>31</b>

## Signs and Symbols



**This symbol on the product or its packaging indicates that this product must not be treated as normal household waste, but must be disposed of at a collection point for the recycling of electrical and electronic equipment.**

(European Directive 2012/19/EU on Waste Electrical and Electronic Equipment (WEEE)).

The environment and general health are endangered by incorrect disposal.

By ensuring that the appliance is disposed of properly, you help to avoid possible hazards.

For more information about the treatment, recovering, and recycling of this product, contact your local city representative, your waste disposal company, or the seller.

Please also dispose of all packaging material with due consideration for the environment.

The materials used are selected carefully and should be recycled. Recycling reduces the use of raw materials and waste.



**This icon indicates a hazardous situation.**

You will find it in particular in all descriptions of the steps that can pose a danger.

Observe these safety instructions and behave accordingly and cautiously. Pass these warnings on to other users.



**This icon indicates a warning.**

You will find it in the description of the work steps which must be particularly observed so that damage to the appliance can be prevented. Also pass on these safety instructions to all appliance users.



**This icon indicates information.**

This symbol indicates useful tips and calls attention to proper procedure and behavior.

The observance of the notes marked with this icon may prevent many problems.



## Safety Instructions

**Your safety is important to us.**

**Please read and follow the following instructions carefully before you start using your hob.**

Make this information available to the appliance's installer as well. This could reduce your installation costs.

### Appropriate use

- This appliance is designed for indoor use and is intended for heating food. Use it exclusively for the intended purpose!
- The manufacturer is not responsible for damage or problems caused by improper handling or failure to observe the instructions.
- The appliance is not suitable for persons with physical, sensory or mental disability or lack of experience and knowledge (including children) unless they are supervised or instructed in the safe use of the appliance and understand the risks involved.
- Children under 8 years of age should always be kept away or constantly supervised.
- Do not let children play with the appliance, sit, stand or climb on it. Cleaning and maintenance of the appliance must not be carried out by children without supervision.
- Do not store objects of interest to children in cupboards above the appliance. Children who climb onto the hob can be seriously injured.
- The appliance is not designed to be operated by a separate remote control or by an external timer.
- Do not use the appliance to heat the room.
- Do not use the cooktop as a storage, shelf or work surface.
- To avoid damage, do not sit or stand on the appliance, do not place any heavy objects on the hob or drop anything on it.
- Only use induction compatible cookwares.
- Heat and moisture are generated in the vicinity of the hob when it is in use. Please make sure that your kitchen is well ventilated.
- To do this, use the options provided or, if necessary, install an extraction system (e.g. a cooker hood).

## **Danger from magnetism**

- This appliance complies with the standards for electromagnetic safety, nevertheless, persons with pacemakers or other electrical implants (such as insulin pumps) must consult their doctor or implant manufacturer before using this appliance to ensure that their implants are not affected by the electromagnetic field. Non-observance of this advice can lead to death!
- Keep magnetizable objects (e.g. credit cards, memory cards) or electronic devices (e.g. computers, MP3 players) away from the hob as they may be affected by the electromagnetic field of the appliance.

## **Installation**

- The appliance must be disconnected from the power supply during installation.
- This appliance may only be installed and grounded by a qualified electrician in accordance with the applicable regulations.
- Changes to the power supply system may only be carried out by a qualified electrician.  
Non-observance of this hint can lead to electric shock or death!
- The edges of the hob are sharp. Protect yourself from injury, e.g. by wearing work gloves, when you touch them.
- It is essential that the appliance is connected to an intact earthing system in accordance with national and local regulations.
- A circuit breaker must be installed in the circuit to which the appliance is connected to ensure complete isolation from the power supply.
- Do not install the hob in an environment with higher temperatures or near a gas or kerosene stove.
- Failure to install the appliance correctly may void any warranty or liability claims.

## **Use**

- If the hob is broken or damaged, disconnect the appliance completely from the power supply and contact our customer service.
- If you continue to use the appliance in this condition, there is a risk of life-threatening electric shock!
- Do not touch hot surfaces when the unit is on, do not touch outside the cooking zone as the surface may contain residual heat.
- Be careful not to touch the heated cooking surface with your body, clothes or objects except suitable cookware and keep children away from the appliance.
- Cooking utensils and handles of cookware can become hot during use. Make sure that they do not protrude over other cooking zones that are switched on.

- Do not place objects on the cooking surface that are not heat-resistant. They could catch fire, melt or be damaged if accidentally switched on.
- Pay attention to magnetizable metal objects worn on the body, as they can become hot near the hob during use. Gold and silver jewelry is not affected.
- Do not place metal objects such as cutlery or lids on the hob, as these can become hot due to induction.
- Never leave the appliance unattended when in use. Overcooked food may burn and cause harmful smoke or catch fire.
- Be especially careful when heating oils and fats (or food containing oils/ fats), as they can easily ignite spontaneously at high temperatures.
- Should a fire occur, never try to extinguish it with water. Switch off the appliance and cover the flame (e.g. with a lid or fire blanket).
- Do not heat any closed containers or cans on the cooking surface. This will bring danger of explosion due to excess pressure during heating!
- To avoid hazards, switch off cooking zones and the hob on when not in use. To do this, use the ON/OFF button and do not rely on automatic deactivation if cookware is not detected.

### **Cleaning**

- Switch off the appliance before cleaning.
- Do not use any aggressive or abrasive cleaning agents or scouring sponges or the like to clean the cooking surface. This can lead to damage.
- Only use a hob scraper with extreme caution and always keep it safe and out of the reach of children to avoid risk of injury.
- Do not use a steam cleaner to clean this product. This may cause electric shock, short circuits and malfunction.
- Always remove sugar-containing food residues immediately and if possible while still hot to avoid permanent staining or damage to the cooking surface.
- Follow the instructions for care and cleaning in the relevant chapter. We accept no liability for improper handling.

### **Repair and maintenance**

- Do not undertake privately to the appliance refit or change internal structure which may cause any hidden safety danger.
- Repair and maintenance work may only be carried out by a qualified electrician.
- Before cleaning or maintenance, disconnect the hob from the power supply.
- If the power supply cable is damaged, it may only be replaced by a qualified electrician.



### 1. Installation



#### 1.1 Important notes and installation requirements

- The hob must be installed by a qualified electrician.
- A circuit breaker (fuse) providing full disconnection from the main power supply must be integrated into the permanent wiring and comply with local regulations.
- This fuse must be tested and have at least 3 mm clearance around all poles (or around all active [phases] conductors, if provided for in the regulations).
- The fuse must be easily accessible.
- Contact a specialist or the building supervisory authority, if you are uncertain during the installation.
- The worktop must be made of insulating and heat-resistant material to prevent electric shocks and deformation caused by heat radiation. Wood and similar fibrous or hygroscopic material must not be used as a material for the worktop unless it is impregnated.
- The worktop must be flat and level and nothing must protrude into the work area.
- The wall above the work surface, adjacent and surrounding surfaces, and any adhesives used must be heat-resistant up to 100°C.
- If the hob is installed above a drawer, furniture compartment, etc. or is accessible from below, a thermal protection barrier must be fitted below the base of the hob (see chapter of inserting the hob).
- Use surfaces that are easy to clean (e.g. ceramic tiles) as wall surfaces around the cooking area.
- The hob must not be installed on cooling equipment, dishwashers or drum dryers.
- The hob must be installed in such a way that proper heat radiation can be ensured to ensure proper functioning.
- Under any circumstances, make sure that the hob is well ventilated and that the supply and air exhaust port is not blocked.  
To do this, follow the instructions described in the following section.

## Installation

### 1.2 Cutting the worktop

- Cut out the work surface according to the sizes shown in the following drawing.

**Note:** Before carving, check that the dimensions indicated correspond to the dimensions of the product.



- Be sure the thickness of the work surface is at least **30 mm**. Choose a heat-resistant work surface material.
- The safety distance between the sides of the hob and the inner surfaces of the worktop must be at least **3 mm**.
- For the purposes of installation and use, a space of at least **5 cm** must be kept around the cut-out.

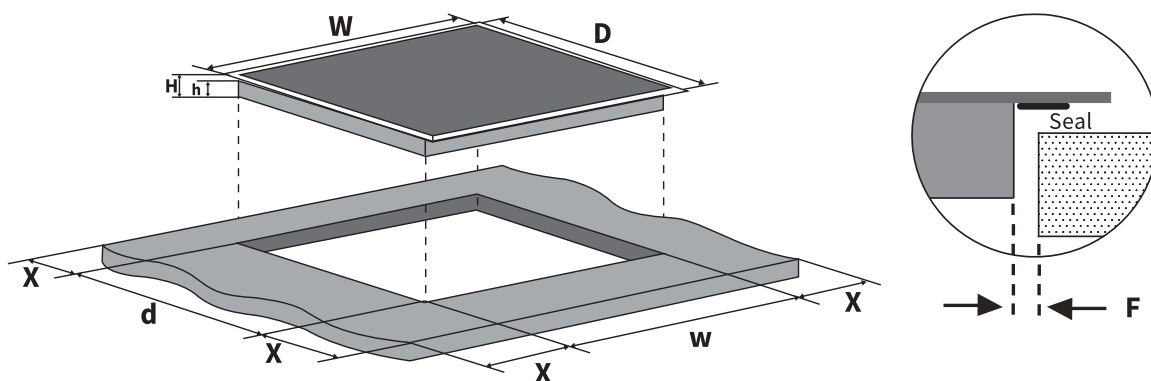

Model	W(mm)	D(mm)	H(mm)	h(mm)	w(mm)	d(mm)	X(mm)	F(mm)
CBBIH3	590	520	58	54	560	495	min. 50	min. 3
CBBIH3B	590	520	58	54	560	495	min. 50	min. 3
CBBIH3BF	590	520	58	54	560	495	min. 50	min. 3

### 1.3 Ventilation and safety distances

- Make absolutely sure that the following conditions are met for adequate ventilation of the hob and that the supply and exhaust air is not blocked:

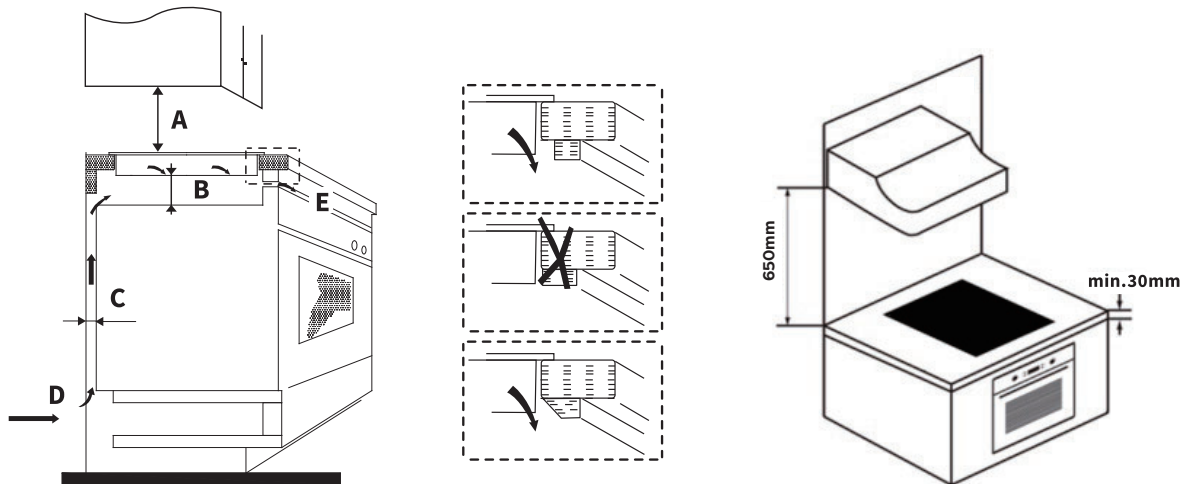

A (mm)	B (mm)	C(mm)	D	E
650	min.50	min.20	Air gap/intake	Exhaust air min. 5mm

- Note: The safety distance between the heating plate and the cabinet or the cooker hood above the heating plate should be at least **650 mm**.
- If the hob is installed above an oven, the oven must have its own fan. The safety distance between the bottom of the hob and the oven must be at least 50 mm.
- The installation must comply with all distance regulations and other regulations.

### 1.4 Inserting the hob

**Note:** On the outside of the hob there are ventilation openings. When inserting the hob, make absolutely sure that they are not blocked by the worktop.



#### Fixing the hob using the mounting brackets

- Place the hob on a stable, smooth surface (For example, use the packaging as a base).
- Make sure that no pressure is exerted on the elements protruding from the hob.

**Attention:** If the size of the opening larger than 565\*495mm, install the mounting bracket.

- Install 4 mounting brackets to the bottom base of the hob as shown in the figure:

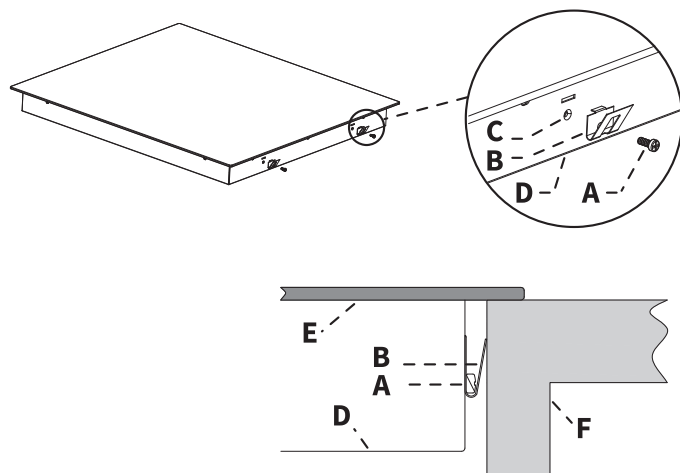

- A** Screw
- B** Mounting bracket
- C** Screw hole
- D** Bottom base
- E** Glass ceramic plate
- F** Worktop

**Note:**

Illustrations may vary

#### Installation of heat protection below the hob

If the hob is installed above a drawer, furniture compartment, or similar, or if the hob is accessible from below:

- Install a protective plate of heat-resistant material (e.g. made of perforated plate to ensure ventilation) at a minimum distance of at least 50 mm below the hob (see illustration).
- When using adhesive, make sure that the temperature resistance is 100°C.

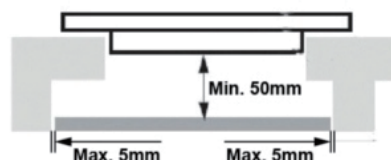

## Installation

### 1.5 Connecting the hob to the mains

- Make sure that the data on the rating plate (V) matches your supply voltage.
- The connection to the power supply must be carried out by a qualified electrician in accordance with the relevant standard or with a single-pole circuit breaker, as described below:

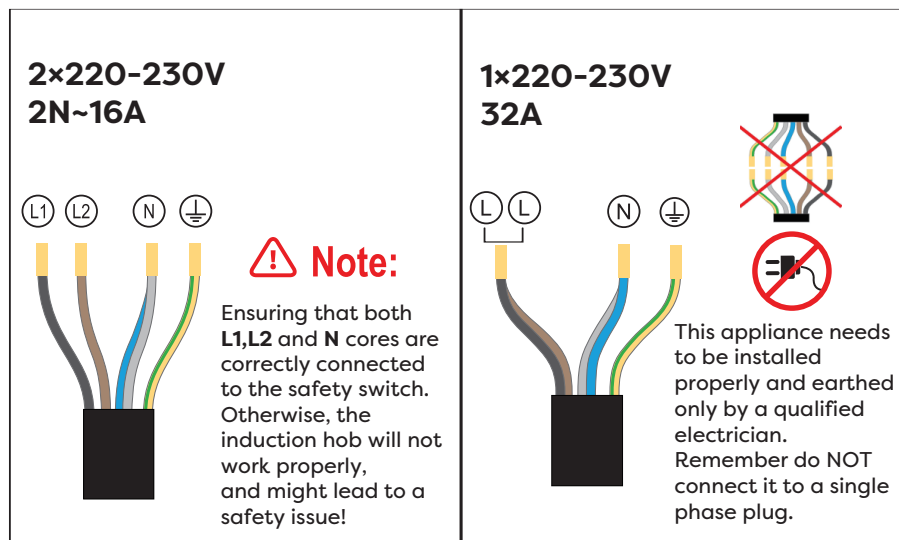

- The electrical connection must be made properly and in accordance with the applicable safety regulations.
- To connect the hob to the main power supply, do not use adapters, reducers, or branching devices as they can cause overheating and fire.
- The cable must not be kinked or pinched.
- The cable must keep away from high-temperature places to avoid circuit failure caused by melting of cable insulation layer which may occur fire or electric shock and other safety accidents.
- The cable must be checked regularly.
- If the cable is damaged or needs to be replaced, this must be done by a qualified electrician with the correct tools.
- The installer must use an H05GG-F type power cable.

**After installation, the connection cable and the underside of the hob must no longer be accessible.**



## Product overview

### 2. Product overview

#### 2.1 Hob elements

##### CBBIH3

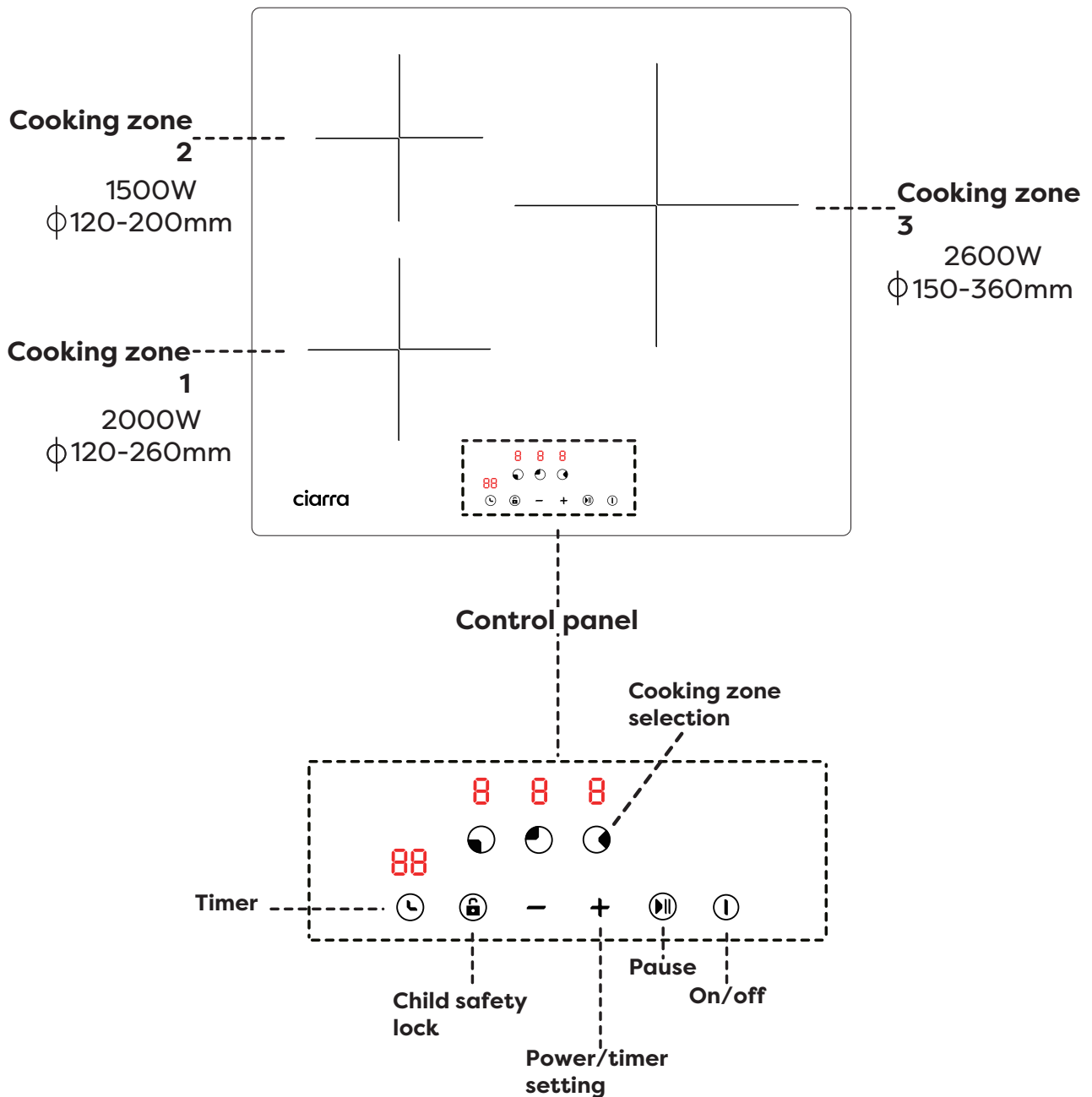

CBBIH3B

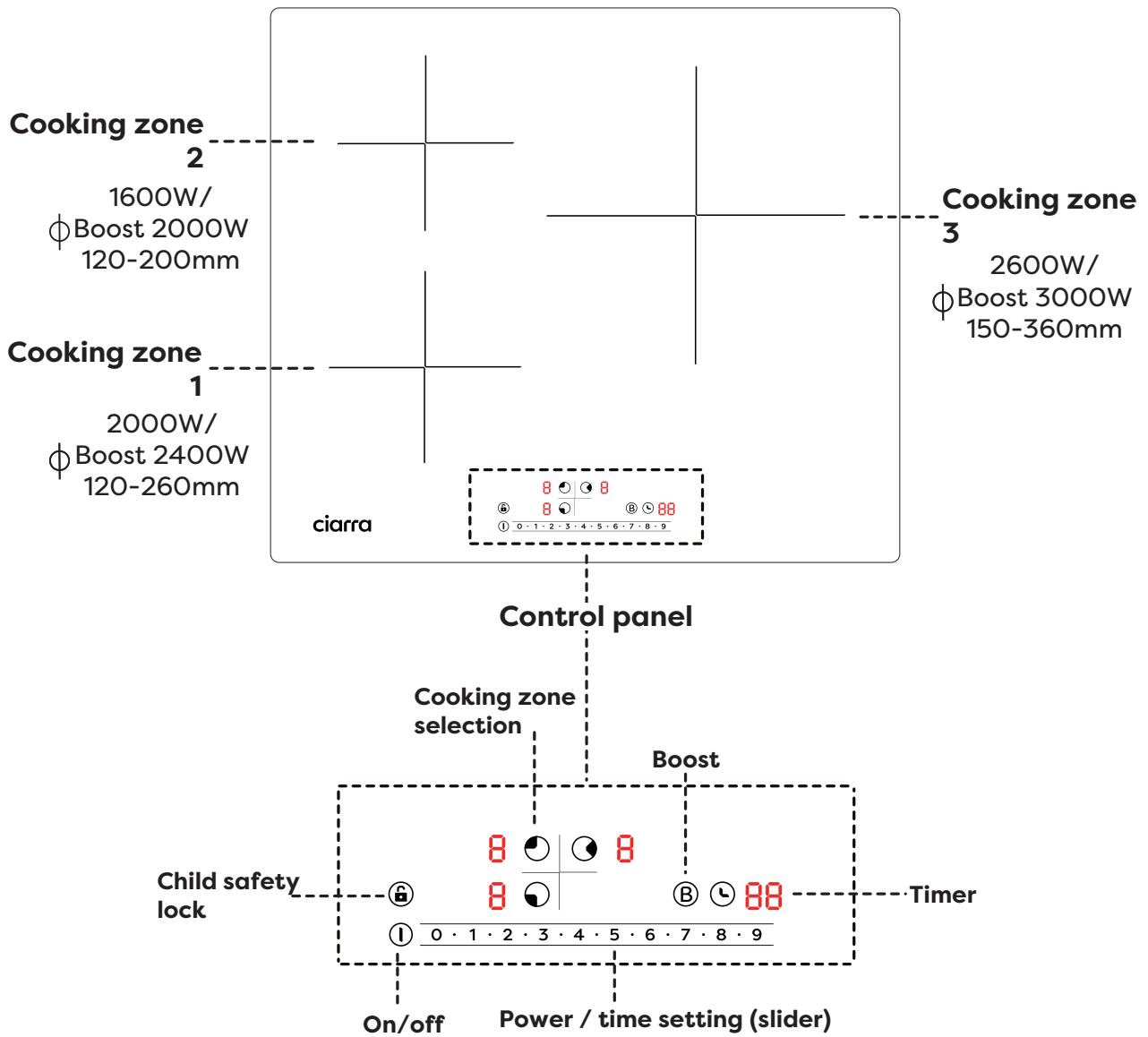

EN

CBBIH3BF

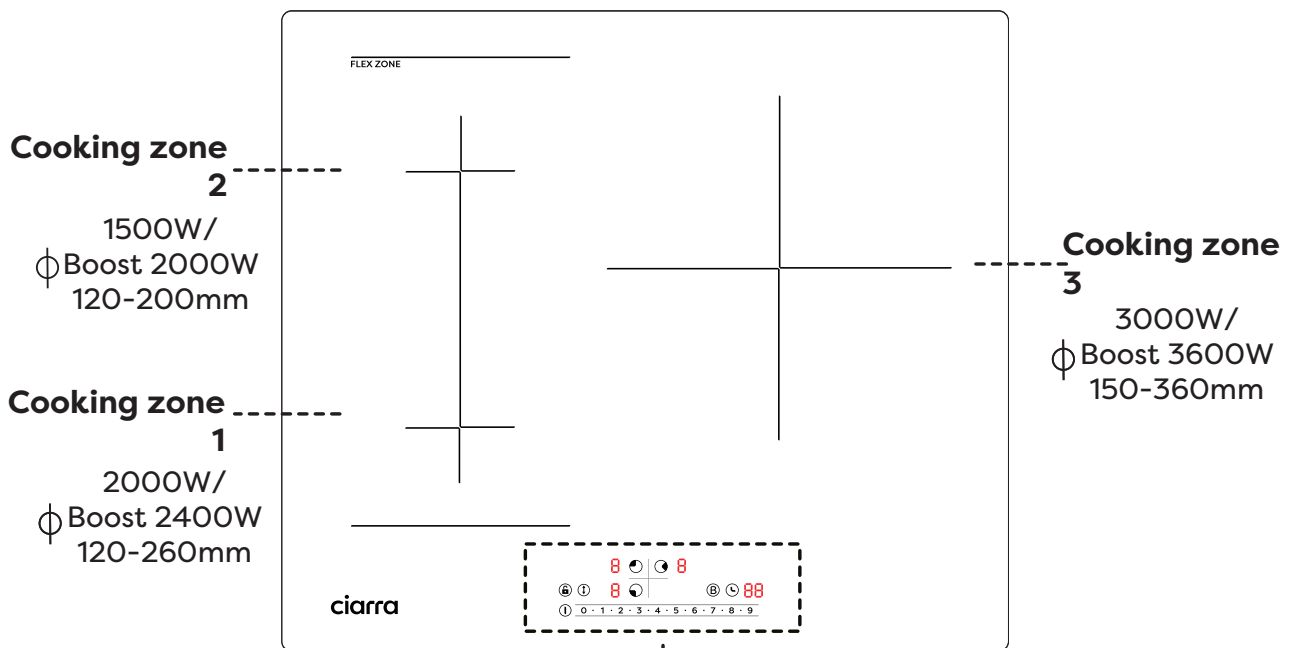

Control panel

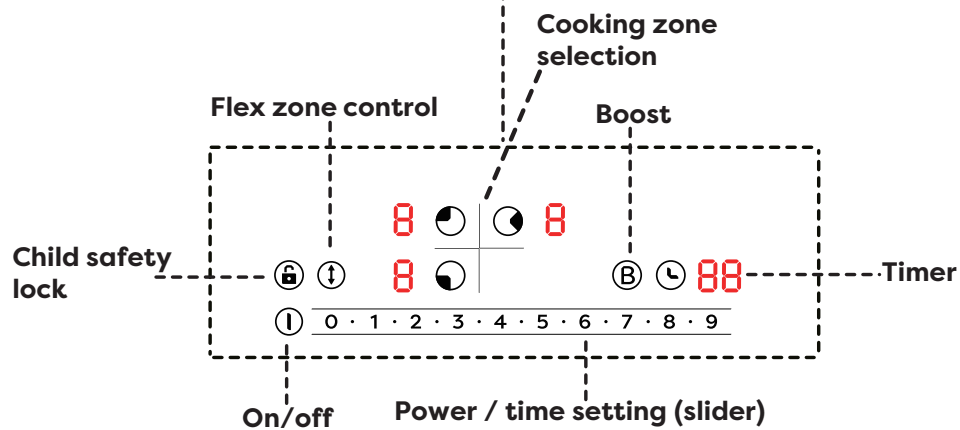



## Before use

### 2.2 How the induction hob works

Induction cooking is safe, advanced and energy efficient.

The heat is generated directly in the metal of the cookware by electromagnetic vibrations and not indirectly by heating the glass surface.

The cooktop only becomes hot because it is finally heated by the cookware.

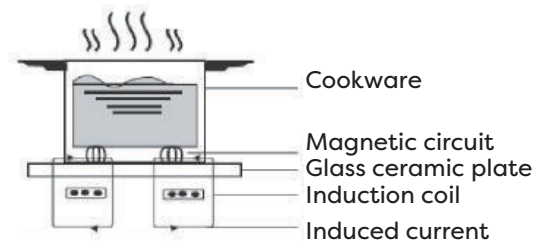

### 3. Before use

Read this guide, taking special note of the **Safety instructions** section.



Remove any protective film that may still be on your induction hob.

**Note:** When the hob is used for the first time, production residues may cause an odor and even some smoke to develop.

This is normal and harmless.

Keep the room well ventilated until these have disappeared (max. 30 min.).



EN

### 3.1 Notes on using the touch controls

- The controls respond to touch, so you don't need to apply any pressure.
- Use the finger pulp, not finger tip.
- You will hear a beep each time.
- Make sure the controls are always clean, dry and that there is no object (e.g. a utensil or a cloth) covering them. Even a thin film of water may make the controls difficult to operate.

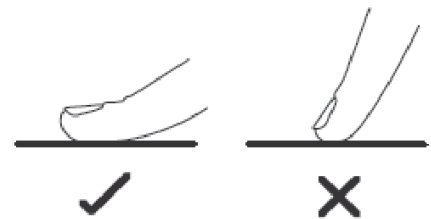

### 3.2 Choosing the right cookware and its use

Only use cookware suitable for induction operation. Pay attention to the labelling when buying it.

As a reminder: magnetic cookware is also suitable for induction.



**Note:**



The proportion of magnetic metal particles varies with different types of cookware. The higher the proportion, the more efficient the heating and the better the automatic detection of the hob for cookware (described in the following section).

**Automatic detection of suitable cookware**

The hob has an automatic recognition system for suitable cookware. If no cookware suitable for induction is detected on a cooking zone, this is indicated by the  icon on the corresponding cooking zone display.

This can have the following reasons:

- The cookware used is not suitable for induction.
- The cookware was not placed on the selected cooking zone.
- The cookware was not placed in the middle of the cooking zone.
- The cookware is too small.

If no suitable cookware is detected, the operation of the corresponding cooking zone will not start. After one minute, it is automatically switched off.



- Make sure that the base of your pan is smooth and sits flat against the glass.
- Do not use cookware with jagged edges or a curved base.
- Use cookware with a minimum base diameter according to the following table.
- For best efficiency, always place the cookware in the middle of the cooking zone.
- Always lift pans off the hob. Do not slide, or they may scratch the glass.



**Optimal cookware dimensions**

The bottom of your cookware should have a certain minimum diameter according to the cooking zone:

Cooking zone	Base diameter of the cookware (mm)	
	Minimum	
1	120	
2	120	
3	150	
Flex-Zone	150	

### 4. Using the hob

#### 4.1 Starting to cook

- Press the ON/OFF button for 3 seconds to turn on.  
After switching on, a signal tone sounds, and all displays light up for about one second and show **--**.
- The hob is in standby mode.
- Now place suitable cookware centrally on the desired cooking zone(s).
- Make sure that the surface of the hob and the bottom of the cookware are clean and dry!
- Touch the selection key for the desired cooking zone. The corresponding power indicator will start flashing.
- The heating level can be adjusted from 1 to 9 before by pressing the "+" or "-"  
Adjust the heating level from 1 to 9 by sliding your finger over the slider or by directly touching the desired intensity level on the slider bar.
- If you don't choose a power setting within 1 minute, the hob will automatically switch off.
- You can change the power at any time during cooking by first selecting the desired cooking zone and on the "+" "-" or slider bar.
- If you press the "-" until the display show 0, the corresponding cooking zone will switch off./ If you touch the left end of the bar for more than 2 seconds, the corresponding cooking zone will switch off.

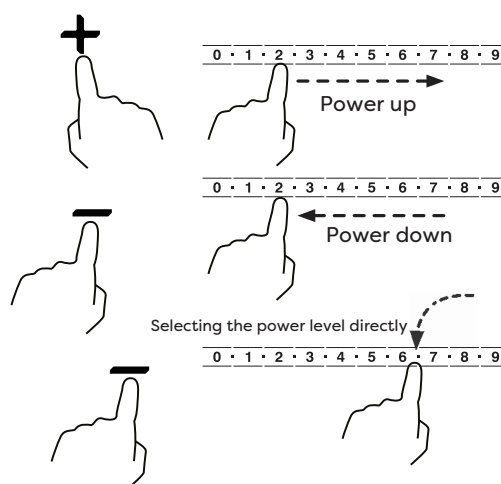
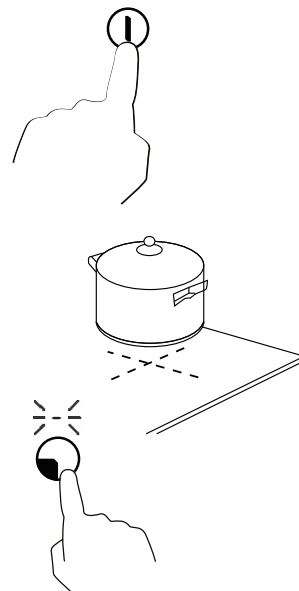

### 4.2 Stop cooking

- To turn off a **cooking zone**, press "-" until the display show 0.
- To turn off a **cooking zone**, press the corresponding selection key and touch the left end of the slider bar for at least 2 seconds.

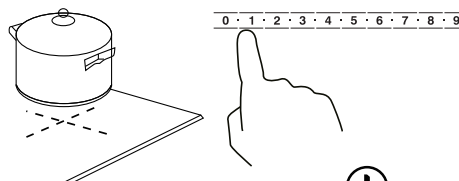

- To switch off the hob, press the ON/OFF button.

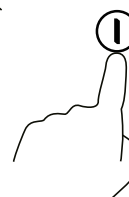

#### Beware of hot surfaces

If a cooking zone is still too hot to touch after use and there is a risk of injury, it is indicated by an "H" on the corresponding cooking zone display, which will disappear again when the surface will have cooled down to a safe temperature.

This can also be used as an energy saving function:

If you want to heat further cooking utensils, use a hot zone.



### 5. Power adjustment mode

**⚠ Note:** The power adjustment mode will change the total power of the induction hob, under the premise of the rated voltage remains unchanged, the current will also change after changing the power, but once exceed the carrying load of line current then may cause tripping, line burning, fire and other risks, please use with caution.

Due to the change of the total power of the induction hob, the power matching between various cooking areas will also change accordingly, and may occur a slight noise due to the frequency difference when different cooking areas working together.

#### 5.1 How to adjust the power:

When the induction hob is powered on and in shutdown state, first press and hold the "Timer" key, then tap and hold the "Child safety lock" key 3 times to enter the power adjustment mode, then the Cooking zone selection shows the power level and "Po" flashes to the right of Timer key. By pressing the "0" or "-" and "9" or "+" keys you can adjust the adjustable power band, finally press the "ON/OFF" key to save and exit.

#### CBBIH3

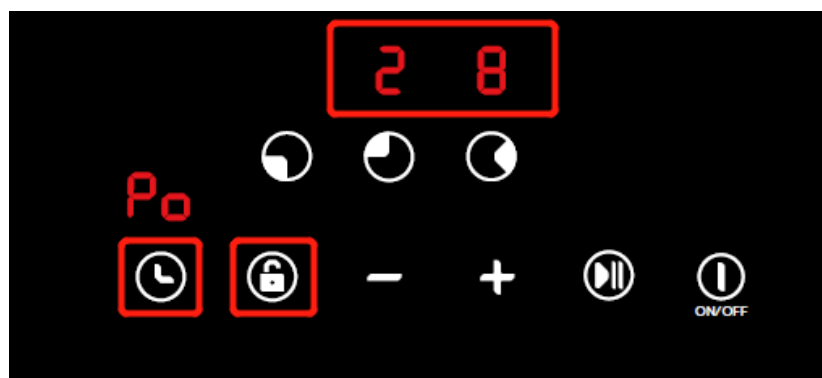

#### CBBIH3B/CBBIH3BF

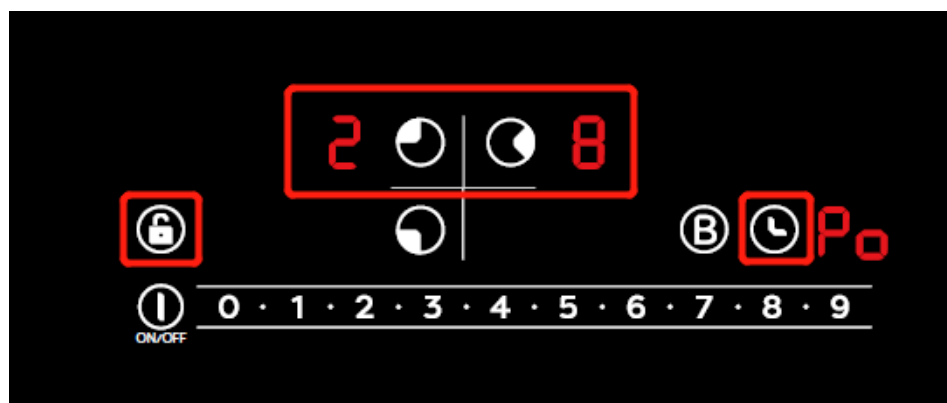

### 5.2 Power adjustment instructions:

#### 1) 2800W (220~230V/13A)

When the cooking zone selection shows "2" and "8" respectively, it means that the total power of the induction hob can only reach the maximum set power of 2800W, and the maximum loadable current is 13A when using this power mode. Due to the power limit, you can only use the two burners on the left side at the same time or the two burners on the right side at the same time. If the increase in power exceeds the maximum limit, the buzzer will indicate "beep" and the operation of the increase in power is invalid.

#### 2) 3500W (220~230V/16A)

When the cooking zone selection shows "3" and "5" respectively, it means that the total power of the induction hob can only reach the set maximum of 3500W, and the maximum current that can be carried in this power mode is 16A. Due to the power limit, you can only use the two burners on the left side at the same time or the two burners on the right side at the same time. If the increase in power exceeds the maximum limit, the buzzer will indicate "beep" and the operation of the increase in power is invalid.

#### 3) 6000W (220~230V/26A)

When the cooking zone selection shows "6" and "0" respectively, it means that the total power of the induction hob can only reach the maximum set power of 6000W, Using this power mode, the maximum loadable current is 26 A. Due to the power limit, if the increase in power exceeds the maximum power limit, then the buzzer will indicate "beep" and the operation of the increase in power is invalid.



#### 4) 7200W (220~230V/32A)

When the cooking zone selection shows "7" and "2" respectively, it means that the total power of the induction hob is back to the maximum 7200W and the maximum loadable current is 32A, then you can connect to the 1\*32A or 2\*16A line.

### 6. The booster function

With the booster function you can maximize the power of a cooking zone for 5 minutes.

#### Activating the booster function

- Press the selection control of the cooking zone for which you want to activate the booster.
- Press the booster key .  
The power of the cooking zone will be maximized; the corresponding power display shows .
- After 5 minutes the booster stops automatically and the cooking zone switches back to power level 9.

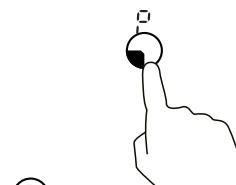
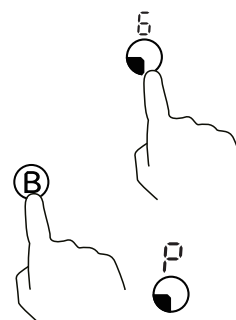

#### Canceling the booster function

- Press the selection key of the cooking zone, for which you want to deactivate the booster.
- To stop the booster and return to the previously set power level (or to level 5 if the booster was activated at power level 0), press the booster key.
- To stop the booster and set any power level, use the slider.
- To switch off the cooking zone completely, touch the left end of the slider bar for at least 2 seconds. The booster will also stop then.

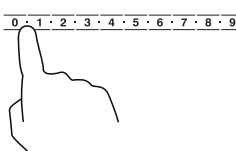
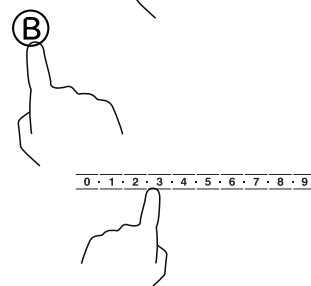

This induction cooktop has auto power protection function, it might restrict the booster function in some cooking zones. 

All cooking zones can be used individually with the booster function, however, due to the power safety & distribution, they are divided into 3 groups if used together.

For groups A and B the following applies:

Operating both zones of a group with the booster activated, is not possible (see illustration).

If the booster is activated for both zones, they are automatically set to power level 9.

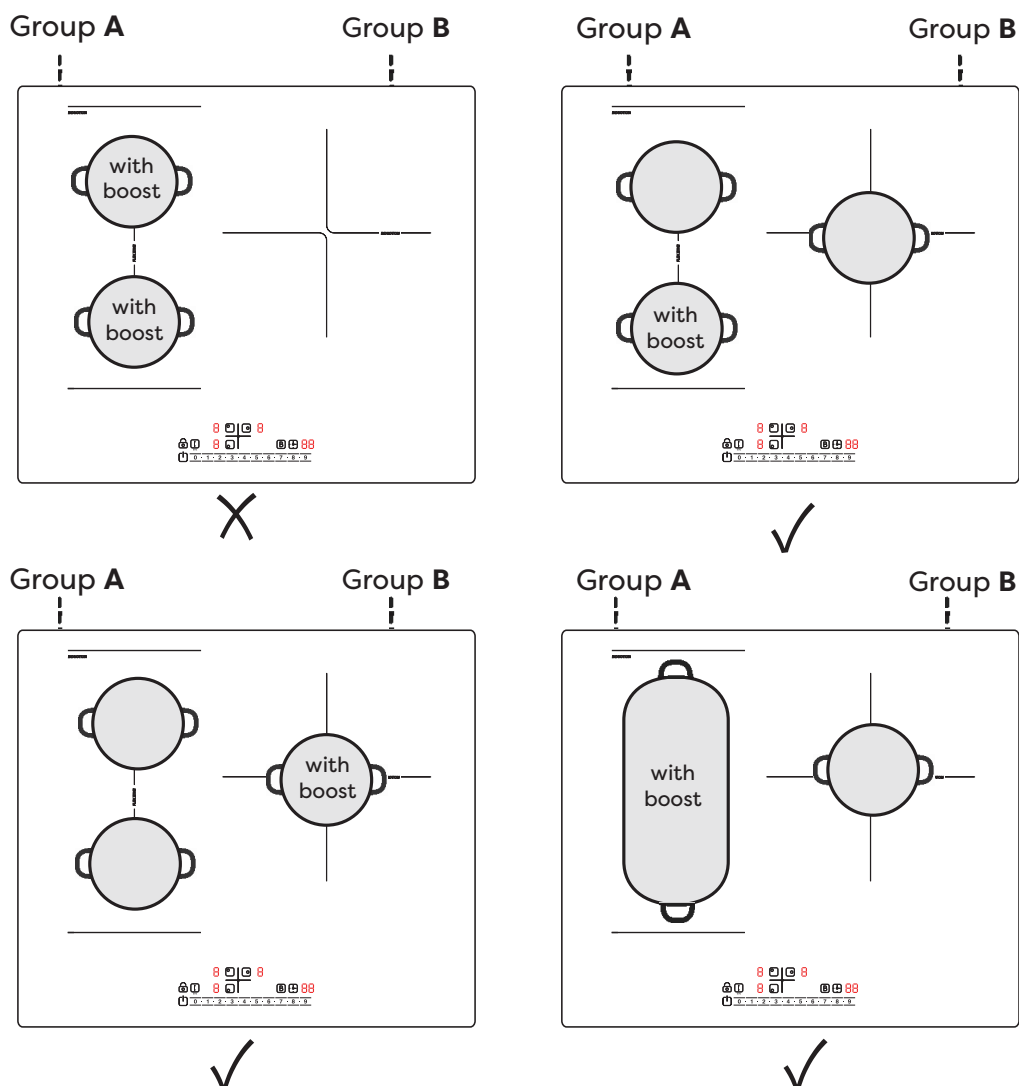



### 7. The flex zone function

- The front and rear cooking zones on the left, (cooking zones 1 and 2,) each form a flex zone. Each flex zone consists of two independent induction zones that can be connected together as one large zone.
- If, during operation as one large zone, the cookware is moved from the front part to the rear part (or vice versa) within the flexible area, the new position is automatically detected; the power level of the zone on which the cookware was originally placed is maintained and the part not covered by the cookware is automatically switched off.
- **Important note:** In flex-zone operation, the cookware must be placed in the middle of the zone, so that both cooking zones are evenly covered.

#### Examples of good and bad placement of cookware:

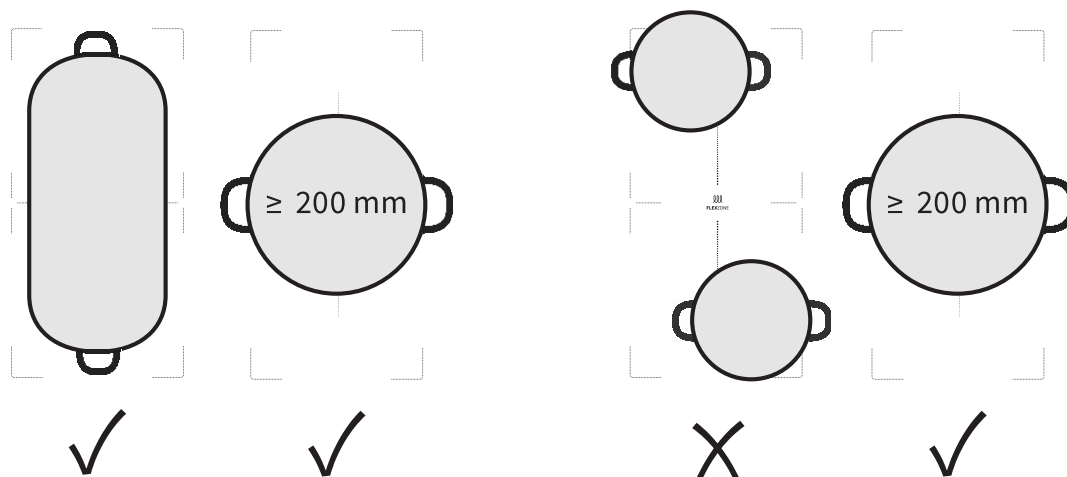

#### Using as one large zone

- To operate the flex zone as one large zone, press the corresponding flex zone button.
- You can use the slider to adjust the power level.

#### Use as two smaller independent zones

- To operate the flex zone as two independent single zones, press the corresponding flex zone key again.

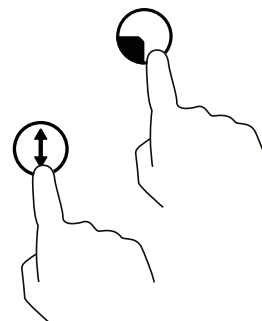

### 8. Using the timer function

#### 8.1 Setting the timer with automatic switch-off of one or more cooking zone(s).

- Select the desired cooking zone with the corresponding selection control.
- Then press the Timer key.  
The timer display will show "30".
- As long as the tens digit is flashing, you can adjust it by using the slider.  
After 3 seconds without further input, the setting is accepted and the ones digit starts flash. Adjust it with the slider as well.
- After 3 seconds without further input, the set time will automatically be confirmed.  
The countdown and start and the timer display will show the remaining time.  
To mark the selected zone, a dot next to the corresponding power display lights up.
- After the set time has expired, the corresponding cooking zone is automatically switched off.

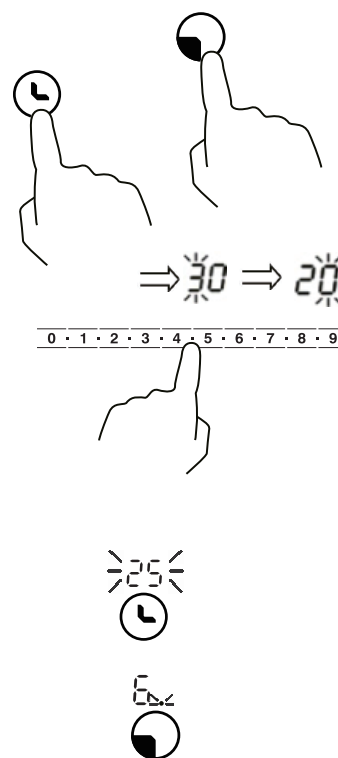

**Note:** Other previously set cooking zones remain unaffected by the timer and remain in operation.



#### Canceling and changing the time setting

- To cancel the time setting, press the timer key again. The remaining time display disappears and the timer is canceled.
- If you want to change the set time after setting the timer, you have to cancel the timer and start again with the first step.

### When activating the timer for several cooking zones

- If the timer is activated for several cooking zones, the timer display always shows the minimum remaining time. A flashing red dot next to the corresponding power display indicates the cooking zone to which the display refers (Example see illustration).

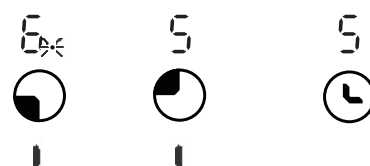

- To display the remaining time of the timer of another cooking zone, touch the corresponding selection key.



- After the shortest set time has elapsed, the corresponding cooking zone switches off, the display changes to the next lowest remaining time and the dot of the corresponding zone flashes.
- When the last remaining timer expires, the corresponding cooking zone is also switched off.

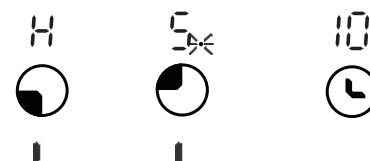

## 9. Safety

### 9.1 Child safety lock

You can lock the control panel to prevent unauthorized use (e.g. by children accidentally switching on the cooking zones).

Even if the control panel is locked, the On / Off key remains active. You can thus switch off the hob at any time in an emergency.



### Locking the control panel

- Touch and hold the child lock/key lock key for at least 3 seconds.
- The timer display will show "Lo" or if the timer has been set before, "Lo" and the remaining time alternately. The control panel is locked except for the on/off key.

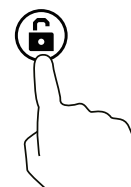

### Unlocking the control panel

- Make sure that the hob is switched on.
- Touch and hold the child lock/key lock key for at least 3 seconds.
- The "Lo" display will disappear. You can now use the hob again normally.

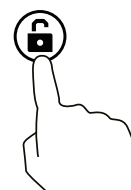

### 9.2 Further safety features

#### Overheating protection

A built-in temperature sensor equipped can monitor the temperature inside the hob.

When an excessive temperature is sensed, the hob will cease operation automatically.

#### Residual heat warning

When a cooking zone has been operating for some time, there will be some residual heat.

To warn you to keep away from it, an "H" will be displayed on the corresponding cooking zone indicator.

#### Magnet monitoring

If small objects (e.g. knife, fork, key) or unsuitable cookware (made of non-magnetic material such as aluminum or of unsuitable size) are placed on the hob, the hob automatically switches to standby mode after 1 minute.

The fan cools down the induction hob for another minute.

#### Automatic shutdown

To prevent cooking zones from being forgotten, they switch off automatically after a set time (see table).

Power level	Automatic switch-off time (h)
1-2	6
3-4	5
5	4
6-9	1.5

### 10. Cooking guidelines

#### Fire hazard!

Be careful when heating oils and fats or food containing oil or fat. These heat up quickly and can easily self-ignite at extremely high temperatures.



#### 10.1 Cooking tips

- When food comes to a boil, reduce the set temperature.
- Using a lid will reduce cooking times and save energy by retaining the heat.
- Minimize the amount of liquid or fat to reduce cooking times.
- Start cooking on a high setting and reduce the setting when the food has heated through.

#### 10.2 Power settings

Power setting	Suitability
1-2	<ul style="list-style-type: none"><li>• Delicate warming for small amounts of food</li><li>• Melting chocolate, butter and foods that burn quickly</li><li>• Gentle simmering</li><li>• Slow warming</li></ul>
3-4	<ul style="list-style-type: none"><li>• Reheating</li><li>• Rapid simmering</li><li>• Cooking rice</li></ul>
5-6	<ul style="list-style-type: none"><li>• Pancakes</li></ul>
7-8	<ul style="list-style-type: none"><li>• Sauteing</li><li>• Cooking pasta</li></ul>
9	<ul style="list-style-type: none"><li>• Stir-frying</li><li>• Searing</li><li>• Bringing soup to the boil, boiling water</li></ul>

### 11. Cleaning the hob



Type of soiling	How to proceed	Important!
<p><b>Everyday soiling of the glass surface (fingerprints, marks, stains left by food or non-sugary spill-overs).</b></p>	<ul style="list-style-type: none"> <li>• Switch off the hob.</li> <li>• Apply a cooktop cleaner while the glass is still warm (but not hot!).</li> <li>• Clean the glass with a soft cloth.</li> <li>• Rinse thoroughly and remove all cleaning residues.</li> <li>• Dry the area completely with a dish cloth or a paper towel.</li> </ul>	<ul style="list-style-type: none"> <li>• Make sure that the hob is not hot.</li> <li>• Scrubbing sponges, some nylon sponges and harsh /abrasive cleaning agents scratch the glass. Check the manufacturer's specifications for suitability for glass surfaces.</li> <li>• Always remove cleaning residues completely. The cooking surface may otherwise be damaged.</li> </ul>
<p><b>Boil-overs, melts and hot sugary spills on the glass surface.</b></p>	<p>Remove these immediately with a spatula, scraper or razor blade scraper suitable for glass ceramic cooktops:</p> <ul style="list-style-type: none"> <li>• Switch off the hob.</li> <li>• Hold the scraper at a 30° angle to the hob and scrape the soiling onto a cool part of the hob.</li> <li>• Remove the soiled area with a dish cloth or paper towel.</li> <li>• Clean, rinse and dry the glass as described under "Everyday soiling".</li> </ul>	<ul style="list-style-type: none"> <li>• Be careful not to burn yourself on heated cooking zones.</li> <li>• Note that the blades of the scrapers are extremely sharp and can cause injury. Keep them out of the reach of children.</li> <li>• Remove this type of soiling as soon as possible to prevent it from sticking to and damaging the glass.</li> </ul>
<p><b>Spillovers on the touch controls.</b></p>	<ul style="list-style-type: none"> <li>• Switch off the hob.</li> <li>• Absorb liquids with a soft cloth.</li> <li>• Wipe the touch control area with a clean, damp cloth or soft sponge.</li> <li>• Dry the area completely with a dish cloth or paper towel.</li> </ul>	<ul style="list-style-type: none"> <li>• If the control panel is soiled, the hob may switch off.</li> <li>• The touch panel may not function as long as there is liquid on it. Make sure that you have wiped the area completely dry before you switch the hob back on.</li> </ul>

### 12. Troubleshooting

Never repair or modify the hob or disassemble it yourself !



#### 12.1 Problems, possible causes and what to do

Problem	Possible cause	What to do
<b>The cooktop cannot be turned on.</b>	No power.	<p>Make sure that the hob is properly connected to the power supply and that it is intact</p> <p>Check whether there is a power outage in your home or area.</p> <p>If you've checked everything and the problem persists, contact a qualified technician.</p>
	Board error.	Contact a certified electrician.
<b>The touch controls are unresponsive.</b>	The control is locked / The key lock has been activated.	Unlock the control panel. See safety chapter.
<b>The touch controls are difficult to operate.</b>	There is a slight film of water on the controls.	Make sure the touch control area is dry.
	You are using the tip of your finger when touching the controls.	Use the finger pulp when touching the controls.
<b>Some keys do not work. /The display does not work normally.</b>	Board / display error.	<p>Disconnect the hob from the power supply and reconnect it after a short time.</p> <p>If the problem persists, contact a certified electrician.</p>
<b>The power indicator is working, but the heating process does not start.</b>	Overheating of the hob.	Ensure that the ventilation paths are not blocked and that the ambient temperature is not too high.
	<p>The cooling fan is not working.</p> <p>Technical error.</p>	Contact a certified electrician.
<b>The cookware is not heated and the  icon is displayed.</b>	The cookware is not suitable for induction or is not detected.	Use induction-suitable cookware in a size suitable for the desired cooking zone and position it correctly. See the cookware chapter.
<b>Operation stops suddenly and the  icon is displayed.</b>	The automatic detection function has failed.	Contact a certified electrician.

## Troubleshooting

Problem	Possible cause	What to do
The  icon is displayed for two cooking zones placed one behind the other (1+2/3+4).	Technical error.	Contact a certified electrician.
The glass is being scratched.	Rough-edged cookware is used.	Use cookware with flat and smooth bottom. See the chapter regarding right cookware.
	Unsuitable, abrasive scourer or cleaning products are being used.	See the cleaning chapter.
Some pans or pots make crackling or clicking noises.	This may be caused by the construction of your cookware (layers of different metals vibrating differently).	This is harmless and normal.
A slight humming noise can be heard when operating at high power.	This can be caused by induction technology.	This is normal, but the noise should quiet down or disappear completely by reducing the power level.
Fan noise.	A cooling fan integrated in the hob prevents the electronics from overheating. If necessary, it continues to run even after the hob is switched off.	This is normal and necessary for error-free operation. Do not disconnect the appliance from the power supply while the fan is running.
Abnormal fan noise.	The cooling fan is damaged.	Contact a certified electrician.
The hob or cooking zone switches off suddenly, a signal tone is heard, and an error code is displayed.	Technical error/ Code meaning see following table.	Note down the error code, disconnect the hob from the power supply and contact a certified electrician.



### 12.2 Error codes

Error code	Meaning	What to do
E1	No suitable cookware was identified.	Place suitable cookware in the middle of the corresponding cooking zone (see the chapter on cookware).
E2	The voltage is too low (less than 85 V).	Check the power supply. If it is normal, turn the hob back on.
E2	The voltage is too high (higher than 285 V).	
E3	Error message of the cooktop sensor/short circuit.	Contact customer service or a certified electrician.
E4	Error message of the IGBT-sensor / short circuit.	
E5	Overheating of the hob.	Wait until the hob has cooled down and then switch it on again.
E6	IGBT overheating.	Wait until the hob has cooled down and then switch it on again.
E7	Malfunction of the cooktop sensor	Contact customer service or a certified electrician.
E7	Ensuring that both L1,L2 and N cores are correctly connected to the safety switch,or communication failure between display and mainboard.	
E8	Overflow protection.	Remove spilled liquids and switch the hob switch the hob on again.

