

**User Manual for
Folding E-scooter**

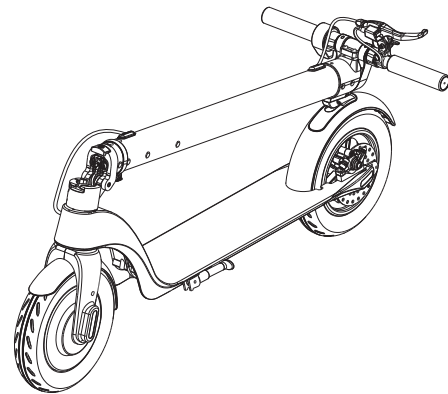

形式：骑马钉（20P）
尺寸：159x110mm

材质：120g双铜
工艺：单色 双面印刷，封面覆哑膜

About the manual

- Congratulations on your purchase of the E-scooter.
- For your driving Safety, please read this user manual carefully before using and ensure to be able to ride the scooter under correct guidance. Learning all the safety warning and tips listed in this manual that will be helpful for you to better control the scooter.
- Please note "warnings" and "tips" in this manual particularly.
Warnings: Improper operation may result in personal injury.
Tips: Helpful advice & clues for the usage of E-scooter.
- Should you have any inquiries, please contact the supplier immediately.

Tips:

- A. Children below 14 years old shall be accompanied by an adult.
- B. The people without experience, poor ability to accept & physical coordination, should learn to ride with companions. Please read this manual carefully before you ride the electric scooter, make sure that you can riding with correct guide.
- C. No parents Accompanied, children are prohibited from cleaning and maintenance of the product.

WARNING!

IMPROPER USE OF THE scooter AND/OR FAILURE TO READ THIS USER MANUAL MAY LEAD TO SERIOUS BODILY INJURY .SELLER WILL TAKE NO RESPONSIBILITY FOR ANY INJURIES CAUSED BY IMPROPER USE WITHOUT FOLLOWING THE MANUAL.

Content

1.Safety Notes.....	3-5
2.Product Introduction	6-10
3.How to ride.....	11-12
4.Battery Instruction.....	13-14
5.Parameter	15
6.Maintenance.....	16
7.Trouble shooting.....	17
8.Packing List	17
9.Product Quality Certificate	18
10.Product Warranty Card.....	18

1 Safety Notes

1.1 About safety

There's risk for any vehicle, including e-scooter. For your safety, please learn to ride safely and obey the local rules and enjoy the riding.

- Please check if the tire is damaged or the spare parts are tight before riding. Please contact local distributor for any unexpected situation.
- Please do not do anything that may harm other people or their properties with e-scooter.
- Any conversion of the e-scooter is prohibited as it will change its performance or damage the structure, which may bring serious injury.
- Please do not put the electric scooter in the water, which will not only damage the electric scooter, but also cause a safety accident.

1.2 Safety Precautions

Please note that you may lose balance, crash or fall down when you ride an e-scooter. To avoid injury, you should be familiar with this manual and keep the e-scooter in good condition.

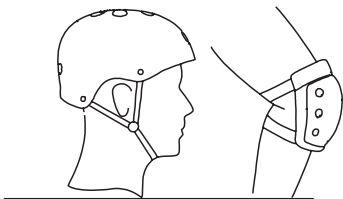

⚠ Safety measurements should be taken before riding, eg: wear sportswear, helmet, kneecap, elbow pads and so on.

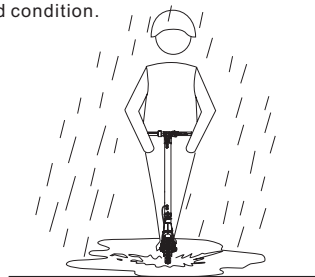

⚠ DO NOT ride when it rains.

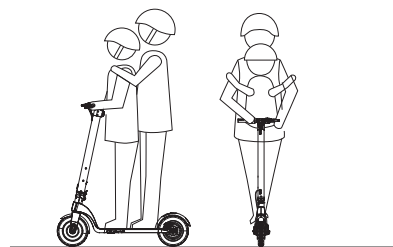

⚠ DO NOT ride with loading
DO NOT ride with two people or more, only for one rider.



⚠ People between 14 and 60 years old may use the product, pregnant is not allowed to ride the e-scooter.



⚠ Max Loading: 100 kg



⚠ DO NOT ride after drinking or taking medicine.

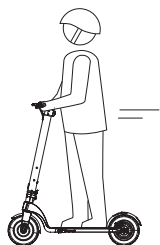

⚠ DO NOT call or listen to music when you ride the e-scooter.



⚠ Be careful of the road with roadblock, sandstone, ponding, mud, wet, ice and snow, slope (angle >15°) stairs, dark area when you are riding.

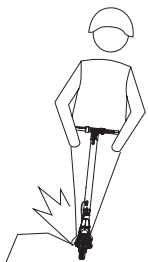

⚠ DO NOT use in dangerous area, where the exploding or catching fire may be caused by something inflammable, explosive or steam, liquid, dust and fiber.

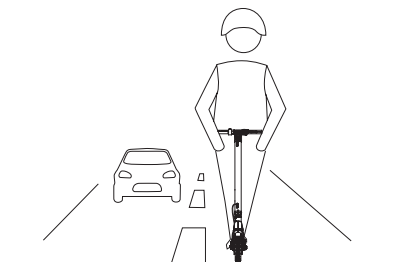

⚠ DO NOT ride on Vehicle road.

2 Production Introduction

2.1 Overall View

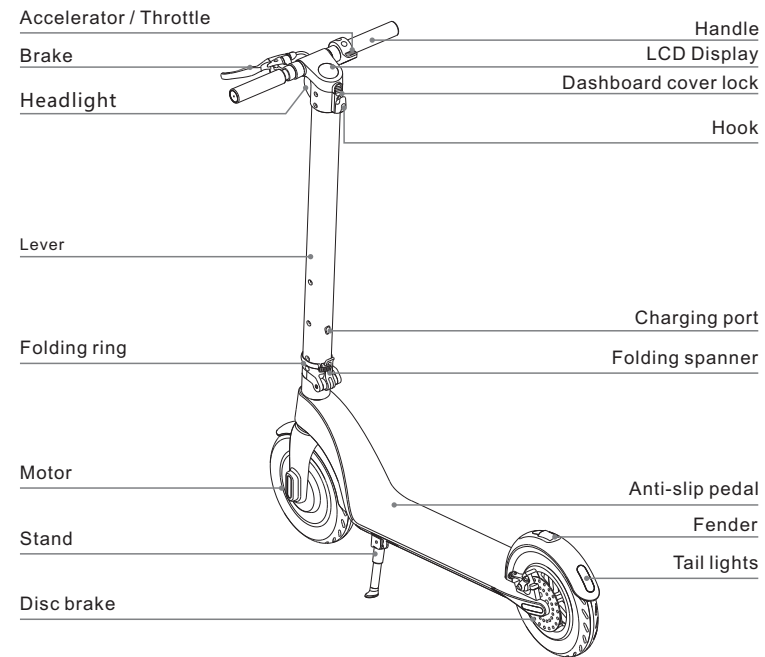

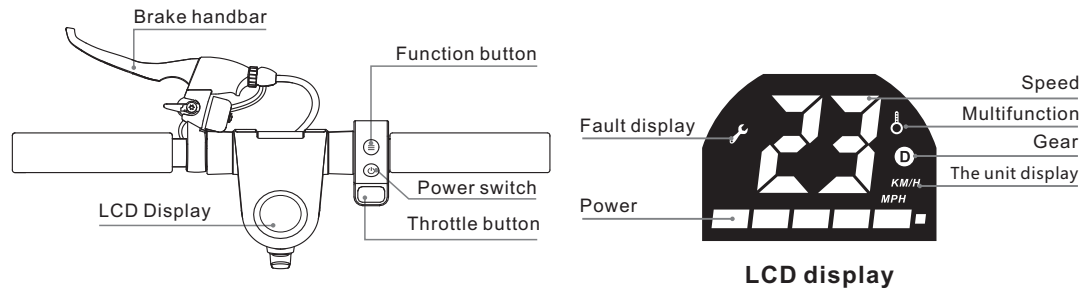

Instructions of Buttons

- 1 **Switch:** long press the power button to turn on/off the power;
- 2 **Acceleration:** press the right acceleration button to start and accelerate;
- 3 **Brake:** hold the brake handle to brake. Lightly step on the rear fender to assist the brakes
- 4 **Short press the function key to directly adjust the speed**
 Beginner mode: no characters in the gear position
 Normal mode: gear characters display white
 Sports mode: gear characters display red
- 5 **Headlights:** Press the function button twice shortly to turn on the headlights, and the taillights are always on;
 In the light-on state, press the function button twice shortly to turn off the headlights and taillights;
- 6 **Cruise mode:** keep the current speed for 6 seconds to enter the cruise mode;
 Exit the cruise mode when pressing accelerator again or brake.

2.2 Pre-assembly instructions

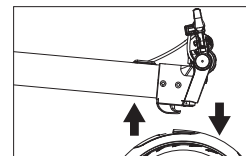
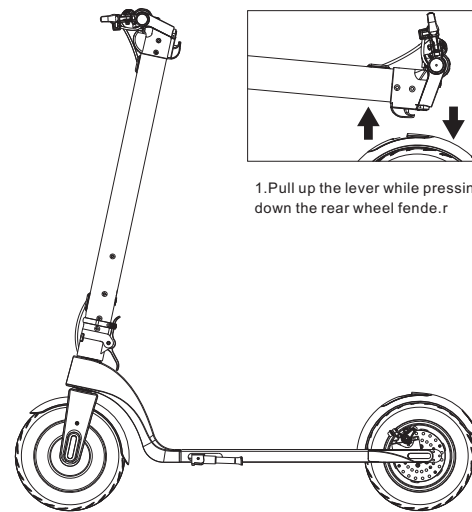

1. Pull up the lever while pressing down the rear wheel fender.

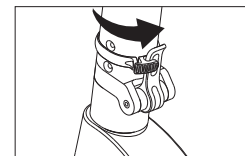

2. Raise the pole, Fasten the folding spanner, And use the folder fixing ring to fix the folder wrench.

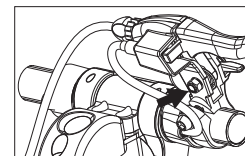

3. Fix the brake lever with M6 hex wrench.

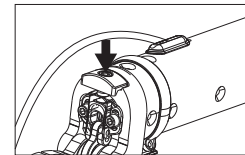

5. According to the shaking condition of the pole, properly adjust the folder screw

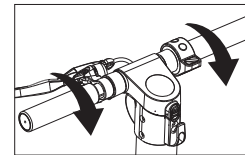

4. Tighten handlebars (Pay attention to the direction of rotation when tighten).

2.3 Folding chart

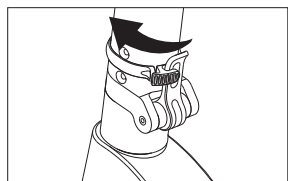

1. Loosen the folder fixing ring.

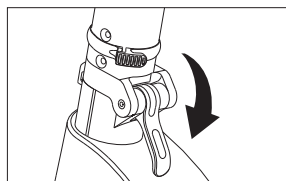

2. Open the folder wrench.

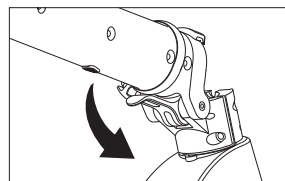

3. Open the folder wrench and lower the pole.

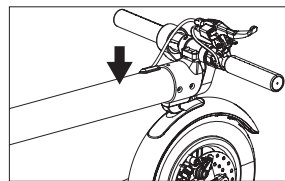
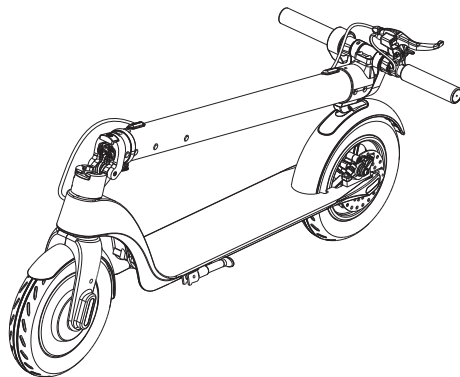

4. Align the hook with the hole of the rear fender and press down.

2.4 Battery Disassemble and assemble Instructions

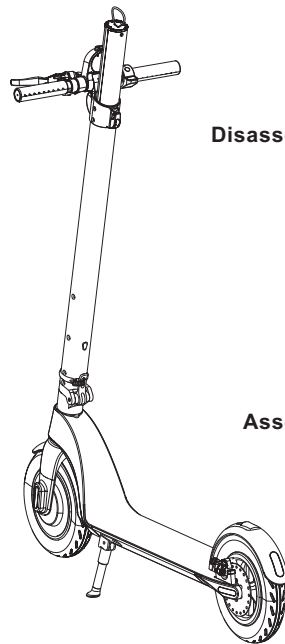

Disassemble

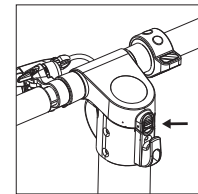

1. Pull up and press the dashboard cover lock to open the cover

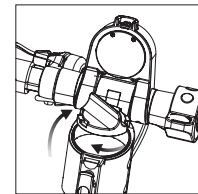

2. Unscrew the battery cover

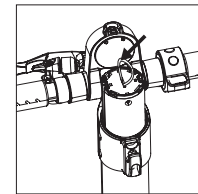

3. Pull the battery straight up to remove the battery

Assemble

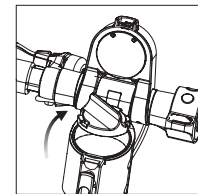

1. Open the dashboard cover and battery cover

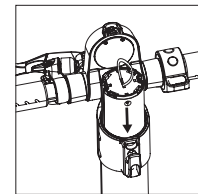

2. Align the battery groove with the groove in the pole and slowly put the battery inside (please pay attention to the groove direction)

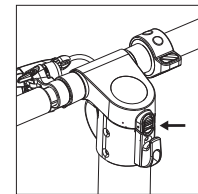

3. Tighten the battery cover and push the dashboard cover lock down, complete the installation.

3 How to ride the scooter

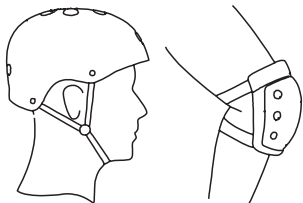

Please wear helmet, kneecap, elbow-pad when you learn to ride the scooter.

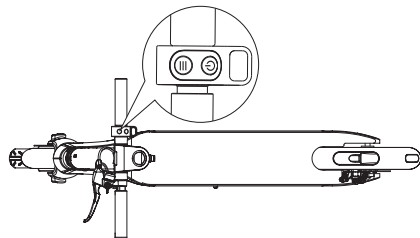

1 Press the POWER button for 2 seconds.

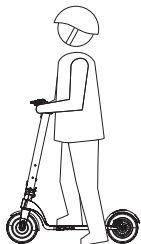

2 Put one foot on the pedal. Push off the ground with your strong leg.

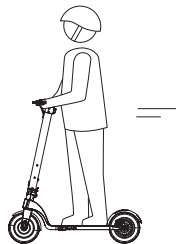

3 Balance both feet on your scooter when you have enough momentum

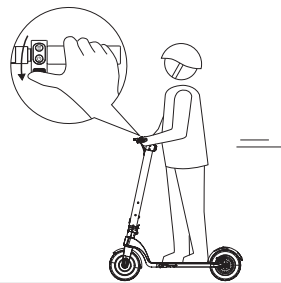

4 Press the THROTTLE button slightly on your right hand to start and rotate the handle to turn

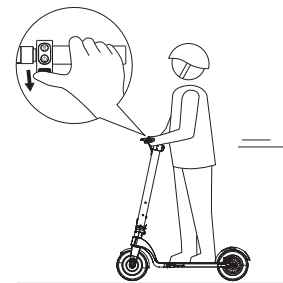

5 Press the THROTTLE button to speed up. Do not ride too fast.

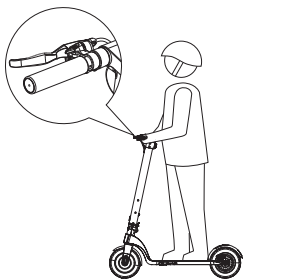

6 Press the brake lever to brake, and gently press the rear fender to assist the brake.



7 When the scooter stops or run at a slow speed, you can get off.

4 Battery Instruction

The instruction shows how to charge and maintain the battery, some safety notices and the specification. Please use the battery properly according to this instruction to prolong the battery life and its performance.

4.1 Battery Parameters

Name	Parameter	Name	Parameter	Name	Parameter
Type	Li-ion battery	Working Temperature	0°C-35°C	Store Time (-10°C-40°C)	3 months (full charge)
Charging Time	3-4 hours	Charging Temperature	0°C-35°C	Initial Volume	5Ah/6.4Ah
Voltage	36V	Max Charging Voltage	42V	Max Charging Current	2A

4.2 Battery Safety

Do not continue to use the battery when the following conditions occur:

- The battery of the electric scooter should be used only with local law. Only for professionals to disassemble and maintain the battery.
- Odor or excessive heat; leak any substance; do not touch anything leaking from the battery.
- Do not let children and animals touch the battery. Must unplug the charger before installing the battery or riding. In the case of charging, it is very dangerous to do anything related to electric vehicles.
- If you want the electric scooter to run most efficiently, the battery must be charged and used within the temperature range indicated in the battery specifications.
- Lithium batteries are considered dangerous and require local law to allow transportation.
- The battery contains dangerous substances. Please do not open the battery. Do not insert anything into the battery.
- It is forbidden to charge a lithium battery that has been over-discharged. A battery that has been over-discharged has a safety hazard and can only be scrapped.

Tip: When the internal temperature of the battery exceeds 45 °C, the battery is protected.

⚠ Do not charge the battery at high temperature (45 °C) or Charge the battery in a high temperature (40 °C) environment.

⚠ Only use the original charging equipment to charge the electric scooter.

4.3 Charging step

- Open the charging port cover, Make sure the charging port is clean and dry.
- Connect the charger with the battery and the other end with power(100V-240V;50/60Hz), make sure the charging indicator is on.
- When the indicator light on the charger changes, indicating that the charging process is normal, otherwise check if the line connection is good.
- When the indicator on the charger has color change, it indicates that the battery has been filled to 99%, Please stop charging; long time over charge will affect the battery life.

Charging method 1:

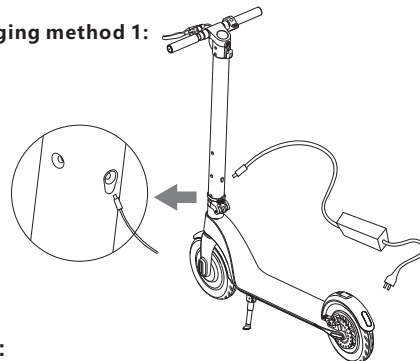

Charging method 2:

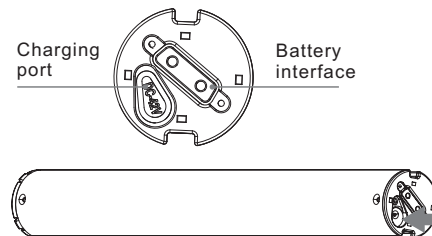

Tips:

Remove the battery to open the silicone charging port, plug the charger DC plug into the battery charging port; plug the power cord into the charger, then connect the other port to the socket (100V-240V; 50/60Hz), and confirm the charger indicator is on normally

Cover the charging port with the anti-dust cap in case some metal may touch the charging port and bring short-circuit after charging finished.

5 Specification

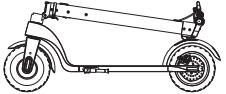
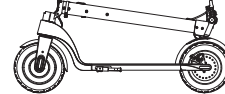
Item	8.5 inch	10 inch
Product		
Scooter Specification		
Unfolded size	1056*420*1166mm	1083*420*1186mm
Folded size	1056*420*450mm	1083*420*460mm
Height from pedal to ground	130mm	135mm
Net weight	12.5kg	13kg
Basic Information		
Capacity	36V/5Ah or 6.4Ah	36V/5Ah or 6.4Ah
Moto power	250W/350W	250W/350W
Mileage per charge	15-25km	15-25km
Max speed	20km/h	20km/h
Max loading	100kg	100kg
Climbing angle	15°	15°
Charger Specification		
Model	FY-4202000	FY-4202000
Input voltage	100-240Vac	100-240Vac
Frequency	50-60Hz	50-60Hz
Output voltage	42V	42V
Output current	2A	2A
Store temperature	-10°C-35°C	-10°C-35°C

6 Maintenance

Maintenance considerations :

- Make sure the electric scooter charger and charging line are disconnected and ensure that the electric scooter is off.
- Wipe the shell with a soft cloth to clean the electric scooter. Please don't put more lubricating oil on bearing when you do the maintenance for it.

⚠ Warning

- It is forbidden to clean electric scooters by using water cannon or soaking in liquid. This will cause permanent damage of the electronic devices in the host.

Storage

- Please charge your electric scooter before storage, for preventing the battery from discharging too long time. Please ensure charge at least once every three months.
- If the storage environment temperature is lower than 0 °C, please don't charge electric scooter. Please put it in inside environment temperature (above 10 °C) and then charge, storage temperature is - 10 °C to 35 °C.
- Please keep the electric scooter in a suitable place indoor, dry and appropriate temperature. You can mask the electric scooter to prevent from the dust.

⚠ Warning

- In order to protect the user's safety, the user can not take apart the electric scooter, otherwise, the user will give up the maintenance warranty rights of the product automatically.

7 Trouble shooting

Please contact the sales office or the dealer with no hesitate for repair when the electric scooter fails to ride normally.

Description of adverse phenomena	Solution
unable starting up	Check to see if the battery is powered
can not charge	1.Check whether the plugboard has electricity ; 2.Check the charger whether connect AC plug (the light whether is on); 3.Check the plug of the charger and the charging port of the whole scooter have been inserted correctly.
No horn, no blue tooth signal	Check the bluetooth switch whether turn on.

8 Packing List

Electric scooter packing list:

E-scooter: 1PC

Charger: 1PC

Manual: 1PC

Screws & Wrench: 1set

Please contact us with no hesitate if there is any breakage or missing when you open package. We will replace it for you as soon as possible.

Have a nice day!

9 Product Quality Certificate

This product is qualified by passing QC inspection and allowed to be sold on the market.

The warranty card (It takes effect upon manufacturer's seal and passing with serial number) regular sales invoice is effective maintenance certificate. Please keep the warranty card properly.

Release date:

QC Qualified Seal:

10 Product Warranty Card

User Files

User Name		Sex		Age	
Address					
Telephone				Zip	
Purchase Site					
Purchase Price			Serial Number		
Commodity And Specifications			The User Signature		
Dealers Signature					

We shall provide warranty service due to non-artificial quality problems.

1. One year warranty to the main body including handlebar stem, Motor, Charger...
2. Battery is 6 months warranty period,
3. Plastic Decorative cover, rubble Handlebar ,rear wheel is not in the scope of warranty.
4. All of damage by man—made(open the housing,tear off the sticker,unnormally using),or losing this card we will not guarantee.