

hiboy
— www.hiboy.com —

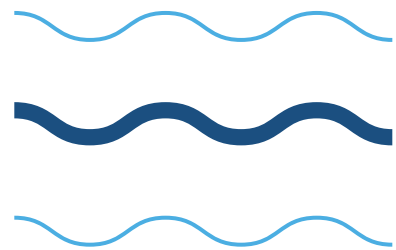

hiboy

ECOM 14
Electric Scooter



The manufacturer reserves the right to make changes to the product and update this manual at any time.

USER MANUAL

Contents

1	Statement	01
2	Package Contents	02
3	Product Overview	03
4	Assembly and Set up	06
5	Charging	08
6	Riding Basics	09
7	Safety Instructions	10
8	Dangerous Actions (No Attempting!)	12
9	Safety Reminder	14
10	Daily Care and Maintenance	15
11	Specifications	19
12	Instructions of Seat&Basket Assembly(Optional)	20
13	Limited Warranty Statement	22
14	Q&A and Trouble shooting	24
15	Contact Us	27

1. Statement

Read and understand this entire manual before
using this product! For assistance contact Hiboy.

PLEASE DO NOT RETURN BEFORE YOUR CONTACTING HIBOY

2. Package Contents

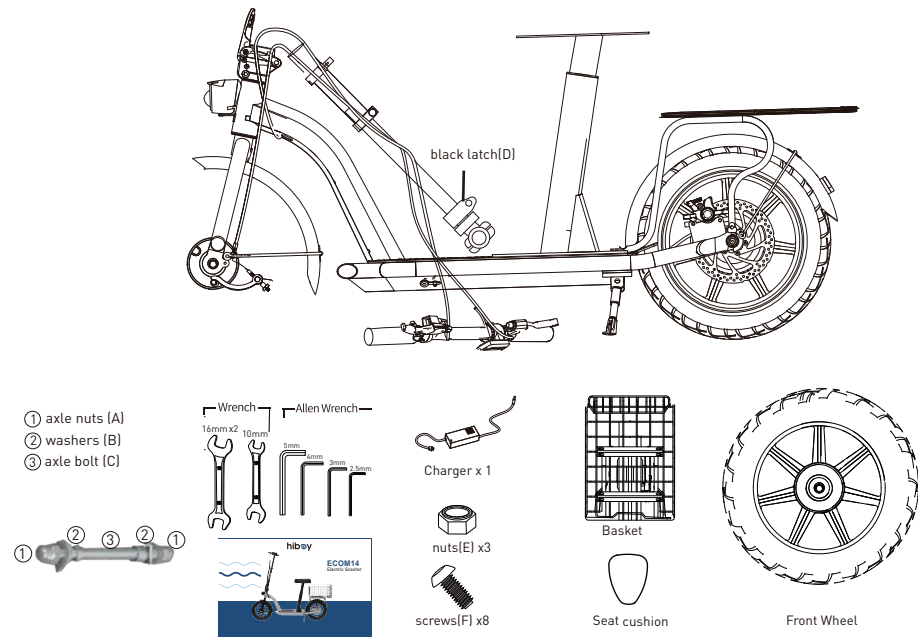

Please check package contents carefully, if anything is missing or damaged, please contact Hiboy customer service for support: support@hiboy.com

3. Product Overview

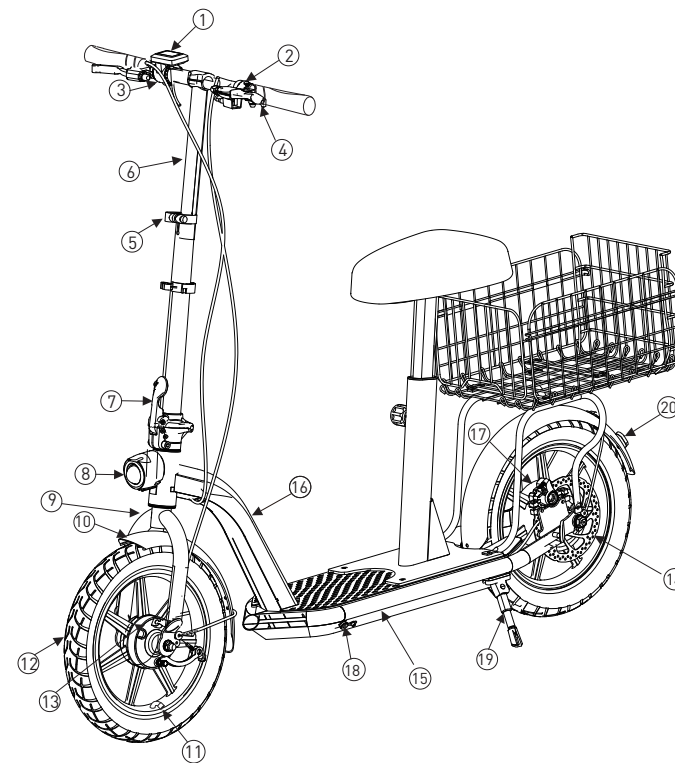

- | | |
|---------------------------|---------------------|
| ① display screen | ⑫ front wheel |
| ② bell | ⑬ drum brake |
| ③ throttle | ⑭ disc brake device |
| ④ brake lever | ⑮ battery |
| ⑤ adjustable height point | ⑯ frame |
| ⑥ T-tube | ⑰ motor |
| ⑦ folding lock | ⑱ charging port |
| ⑧ headlight | ⑲ kickstand |
| ⑨ front fork | ⑳ taillight |
| ⑩ front fender | |
| ⑪ inflation inlet | |

Recommended tire pressure: 35-45 PSI (240-310 kpa)

WARNING:
Do not use the electric scooter for the first time until you have inflated the tires to the correct PSI. Failure to do so may damage your electric scooter and void your warranty.

Screen Display

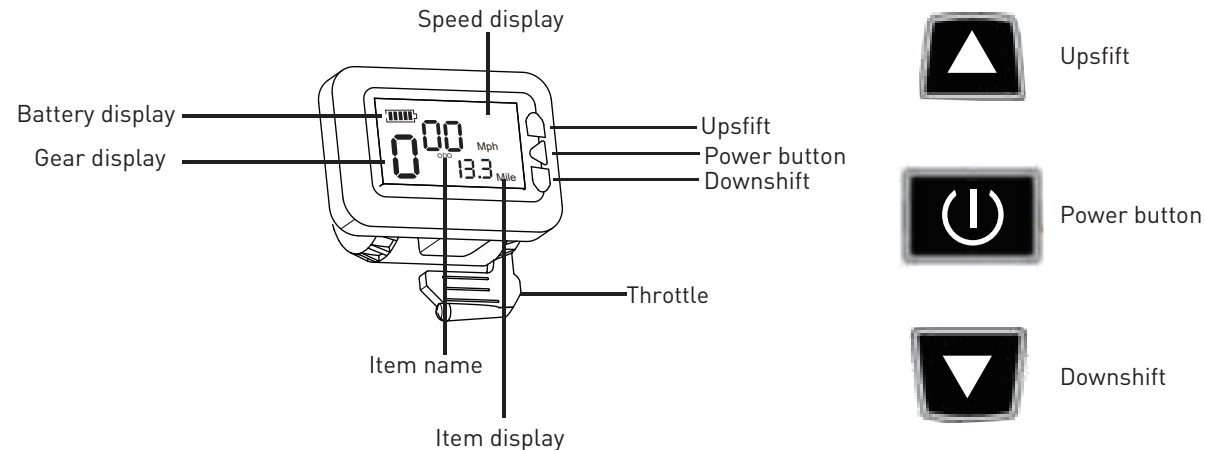

Gear Mode

Click "▲" and "▲" button to adjust Gear Mode (0Gear(0MPH),1Gear(9MPH),2Gear(16MPH),3Gear(22MPH))

Item Name (Press power button to switch item name)

ODO:Total mileage display // Trip:Single time range display // VOL:Current Voltage // Time:Single riding time//

Throttle: Press throttle to accelerate

Battery Display

Each battery bar represents 25% power,when the battery is below 25%,the battery needs to be charged.

Setting Screen

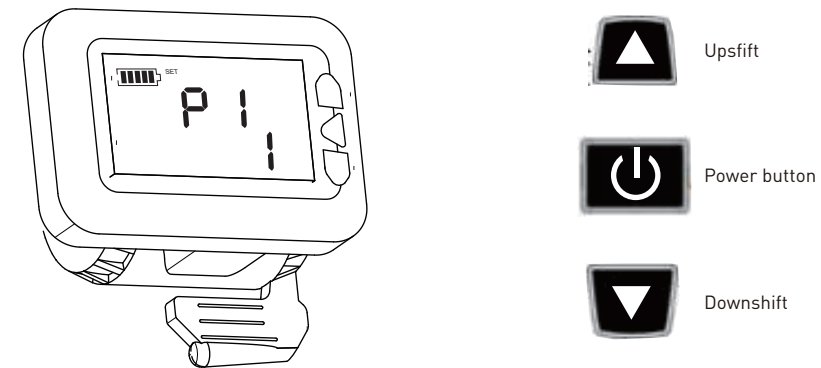

Hold down the up or down key to enter the setting screen

1. Press the power button to switch the P1 // P2 // P5
2. P1 : adjust the screen brightness
3. P2 : switch to Mile or KM
4. P5 : adjust the Cruise Control

Press up or down to switch whatever you choose P1, P2 or P5

4. Assembly and Set up

Before you begin: Remove contents from box. Remove the separators that protect the components from damage during shipping. Inspect the contents of the box for scratches in the paint, dents, or kinked cables that may have occurred during shipping. Because the electric scooter was partially assembled and packed at the factory, there should not be any problems, even if the box has a few scars or dents.

MAKE SURE POWER SWITCH IS TURNED "OFF" BEFORE CONDUCTING ANY ASSEMBLY OR MAINTENANCE PROCEDURES.

Hiboy recommends assembly by an adult with experience in bicycle mechanics.

Unfold the Scooter

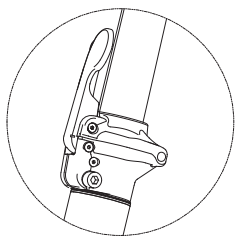

Open the folding lock

Attaching the Handlebars

Required Tools: 5 mm Allen Wrench (included)

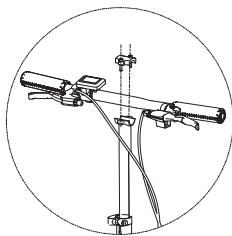

1. Loosen the screw on Top of T-tube
2. Put the handle bar on(the thread part should be in the middle)

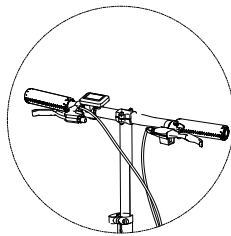

3. Tighten the screw
Note:Please lock the brake cables with the black latch on the T-tube (to prevent the cables clutter)

Attaching the Front Wheel

Required Tools:16mm Wrenches*2(Included)

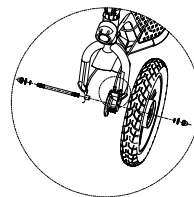

- 1.Remove axle nuts (A) and washers (B) from the axle bolt (C)
- 2.Pull axle bolt(C) out of the front fork
- 3.Discard the black latch(D)

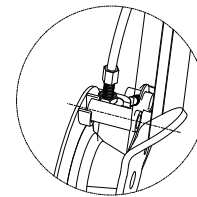

- 4.The drum brake is aligned with the middle of the front wheel

Note: the drum brake cable should be placed in the front fender connecting rod

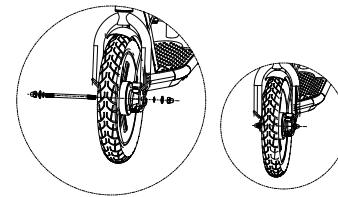

- 5.Insert the front wheel into the front fork
- 6.Insert the axle bolt (C) into the middle hole of drum brake, tighten the axle nuts (A) and washers (B) on two sides

⚠ Need Help? Please search "Hiboy us" on Youtube website to find our Channel. You can watch the Installation video of ECOM 14. Or contact Hiboy after-sale team by email: support@hiboy.com.

⚠ Need Help? Please search "Hiboy us" on Youtube website to find our Channel. You can watch the Installation video of ECOM 14. Or contact Hiboy after-sale team by email: support@hiboy.com.

5. Charging

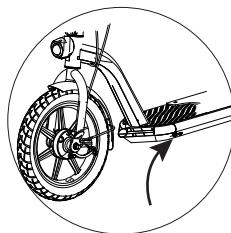
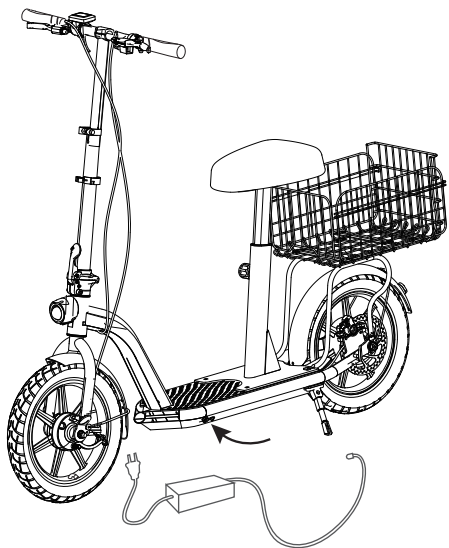

Open the rubber cover

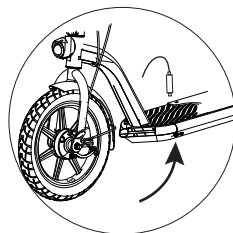

Insert the charger plug in

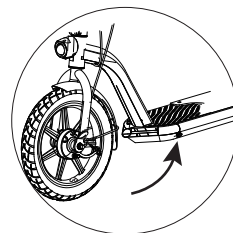

Fill and fix the rubber plug after the charging

Your scooter will be fully charged when the LED light on the charger changes from red (charging) to green (fully charged). After a period of full charge, it will automatically cut off the charging. Even so, we still don't recommend to charge your scooter for a long time. Do not connect the charger if the charging port is wet. Cover the charging port when not use.

6. Riding Basics

Brake Check the brake for proper function. When you squeeze the brake lever, the brake should provide positive braking action. Make sure brake is not rubbing when the lever is released. When you apply the brake with the throttle on/engaged, the brake cut-off switch should cut power to the motor.

Wheels Periodically inspect the wheels for excessive wear.

Tires Periodically inspect the tires for excess wear and replace as needed. Regularly check the tire pressure and inflate as needed.

Frame, Fork and Handlebars Check for cracks or broken connections. Although broken frames are rare, it is possible for an aggressive rider to run into a curb or object and wreck, bend or break a frame. Get in the habit of inspecting your scooter on a regular basis.

Hardware/Loose Parts Before every ride, check all parts, such as nuts, bolts, fasteners, etc., to ensure they are secure and assembled correctly. There should not be any unusual rattles or sounds from loose parts or broken components. If you cannot solve the abnormal sound problem, please contact Hiboy after-sales team immediately. Our email is support@hiboy.com.

Safety Gear Always wear proper protective equipment, such as an approved safety helmet (with chin strap securely buckled), elbow pads, and kneepads. A helmet may be legally required by local law or regulation in your area. A long-sleeved shirt and long pants are recommended. Always wear shoes and keep shoelaces tied and out of the way of the wheels and motor and drive system. **NEVER RIDE BAREFOOTED OR IN SANDALS.**

Laws and Regulations Always check and obey any local laws or regulations.

Insurance

Do not assume that your existing insurance policies necessarily provide coverage for product use. Check with your insurance company for information regarding insurance.

Storage

Prolonged exposure to UV rays, rain and the elements may damage the enclosure materials, store indoors when not in use.

7. Safety Instructions



 Do not ride in the rain.

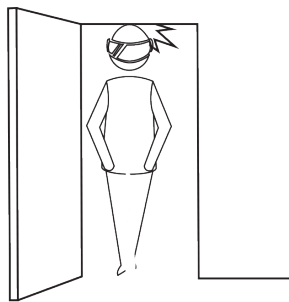

 Look out for doors, elevators and other overhead obstacles.

10



 Keep your speed between 3.1-6.2 mph when you ride through speed bumps, elevator door sills, bumpy roads or other uneven surfaces. Slightly bend your knee to better adjust mentioned surfaces.



 Do not accelerate when you go downhill.

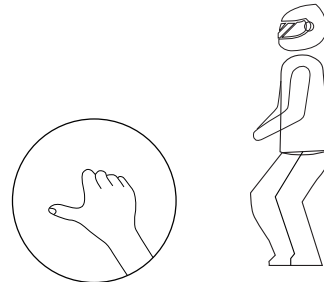

 Do not press the throttle when you're walking alongside the scooter.

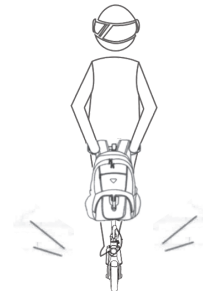

 Do not hang bags or other heavy stuff on the handlebar.

11





 Always steer clear of obstacles.



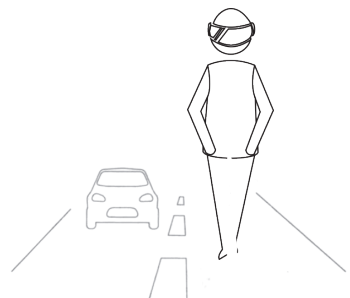

 Keep both feet on the deck all time.

8. Dangerous Actions(No Attempting!)

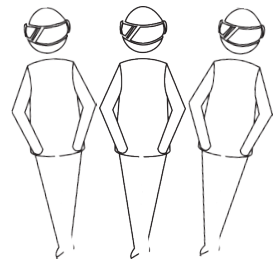

 Do not ride in traffic lanes or residential areas where vehicles and pedestrians are both allowed.



 Do not turn the handlebar violently during high-speed riding.

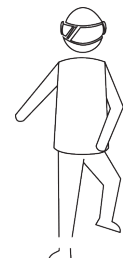

 Do not keep your feet on the rear mudguard.

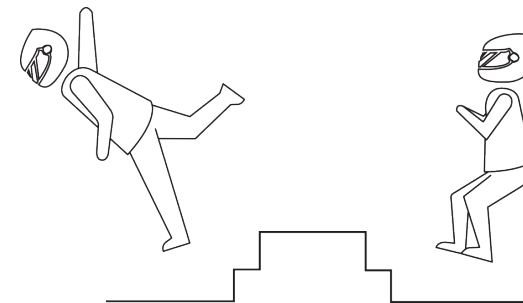

 Do not try riding up or down stairs, and jumping over obstacles.



 Do not ride with anyone else, including children.



 Do not keep your hands away from handlebar.

9. Safety Reminder

- This electric scooter is a leisure device. But once they're in a public area, they'll be seen as vehicles, subjecting to any risks faced by vehicles. For your safety, please follow instructions in the manual and traffic laws and regulations set forth by government and regulatory agencies. (Pour votre sécurité, veuillez suivre les instructions contenues dans le manuel et les lois sur la circulation et les règlements énoncés par les organismes gouvernementaux et réglementaires).

- At the same time, you should understand that risks cannot be entirely avoided as others may violate traffic regulations and drive incautiously, and you're exposed to road accidents just as when you're walking or biking. The faster the scooter is, the longer it takes to stop. On a smooth surface, the scooter may slip, lose balance, and even result in a fall. Thus it is crucial that you use caution, keep proper speed and distance, especially so when you're unfamiliar with the place.

- Respect pedestrians' Right of Way. Try not to startle them while driving, especially children. When you ride from behind pedestrians, ring your bell to give them a heads-up and slow your scooter to pass from their left (applicable to countries where vehicles drive on the right). When you ride across pedestrians, keep to the right at a low speed. When you drive across pedestrians, keep the lowest speed or getting off the vehicle.

- Closely follow the safety instructions in the manual especially in the countries that lack relevant laws and regulations regarding electric scooters. Hiboy shall not be liable for any financial losses, physical injuries, accidents, legal disputes and other interest conflicts resulted from actions that violate user instructions.

- Do not lend your scooter to whoever doesn't know the operations. And when you do lend it to your friends, please take the responsibility to ensure he/she knows the operation and wears the safety gear.

- Check the scooter before every use. When you note loosen parts, low battery alerts, excessive wear, strange sounds, malfunctions and other abnormal conditions, stop riding immediately and call for professional support.

- Devices are not intended for use at elevations greater than 2000 m above sea level Prolonged Exposure to UV Rays, Rain and the Elements May Damage the Enclosure Materials, Store Indoors When Not in Use.

- **WARNING – Risk of Fire – No User Serviceable Parts.**

- **AVERTISSEMENT - Risque d'incendie - Aucune des pièces ne peut être réparée par l'utilisateur.**

10. Daily Care and Maintenance

Cleaning and storage

If you see stains on the scooter's body, wipe them off with a damp cloth. If the stains won't scrub off, put on some toothpaste, and brush them with a toothbrush, then wipe them off with a damp cloth. If you see scratches on plastic parts, use sandpaper or other abrasive materials to polish them.

Notes: do not clean the scooter with alcohol, gasoline, kerosene or other corrosive and volatile chemical solvents to prevent dire damage. Do not wash the scooter with a high-pressure water spray. During cleaning, make sure that the scooter's turned off, the charging cable is unplugged, and the rubber flap is closed as water leakage may result in electric shock or other major problems.

When the scooter's not in use, keep it indoors where it is dry and cool. Do not put it outdoors for long time. Excessive sunlight, overheating and overcooling accelerate tire aging and compromise the scooter and the battery pack's lifespan.

(Lorsque le scooter n'est pas utilisé, gardez-le à l'intérieur dans un endroit sec et frais. Ne le mettez pas en plein air pendant longtemps. La lumière du soleil excessive, la surchauffe et le sur-refroidissement accélèrent le vieillissement des pneus et compromettent le scooter et la durée de vie de la batterie.)



WARNING!

Battery maintenance

1. Use original battery packs, use of other models or brands may bring about safety issues;
2. Do not touch the contacts. Do not dismantle or puncture the casing. Keep the contacts away from metal objects to prevent short circuit which may result in battery damage or even injuries and deaths;
3. **Use original power adapter to avoid potential damage or fire;**
4. Mishandling of used batteries may do tremendous harm to the environment. To protect natural environment, please follow local regulations to properly dispose used batteries;
5. **After every use, fully charge the battery to prolong its lifespan.**

Do not place the battery in an environment where the ambient temperature is higher than 104°F or lower than 14°F (e.g., do not leave the scooter or the battery pack in a car under direct sunlight for an extended time). Do not throw the battery pack into fire as it may lead to battery failure, battery overheating, and even another fire. **If the scooter is expected to be left idle for more than 30 days, please fully charge the battery and place it in a dry and cool place. Keep in mind to recharge it every 60 days to protect the battery from potential damage which is beyond limited warranty.**

Always charge before exhausting the battery to prolong the battery's lifespan. The battery pack performs better at normal temperature, and poor when it is below 32°F. For instance, when it is below -4°F, the riding range is only half or less at normal state. When the temperature rises, the riding range restores.

The damage caused by prolonged no charge is irreversible and is beyond limited warranty. Once the damage is done, the battery can not be recharged.

ISED Canada Statement:

This device contains licence-exempt transmitter(s)/receiver(s) that comply with Innovation, Science and Economic Development Canada 's licence exempt RSS(s). Operation is subject to the following two conditions:

(1) this device may not cause interference and

(2) this device must accept any interference, including interference that may cause undesired operation of the device.

Radiation Exposure: This equipment complies with Canada radiation exposure limits set forth for an uncontrolled environment To maintain compliance with IC's RF Exposure guidelines, this equipment should be installed and operated with minimum distance of 5mm the radiator your body. This device and its antenna(s) must not be co-located or operation in conjunction with any other antenna or transmitter

Déclaration de l'ISED Canada:

Cet appareil contient des émetteurs / récepteurs exempts de licence qui sont conformes aux RSS exemptes de licence d'Innovation, Sciences et Développement économique Canada. L'opération est sous réserve des deux conditions suivantes :

(1) cet appareil ne peut pas causer d'interférences et

(2) cet dispositif doit accepter toute interférence, y compris

peut provoquer le fonctionnement indésirable de l'appareil.

Exposition aux rayonnements: Cet équipement est conforme aux radiations du Canada limites d'exposition pour un environnement incontrôlé Pour maintenir le respect des guides d'exposition RF d'IC, cquipment doit être installé et actionné avec une distance minimale de 5mm le radiateur de votre corps. Cet appareil et ses antennes ne doivent pas être co-localisé ou en opération en conjonction avec toute autre antenne ou émetteur

FCC Warning Statement

Changes or modifications not expressly approved by the party responsible for compliance could void the user's authority to operate the equipment. This equipment has been tested and found to comply with the limits for a Class B digital device, pursuant to Part 15 of the FCC Rules. These limits are designed to provide reasonable protection against harmful interference in a residential installation. This equipment generates uses and can radiate radio frequency energy, if not installed and used in accordance with the instructions, may cause harmful interference to radio communications. However, there is no guarantee that interference will not occur in a particular installation. If this equipment does cause harmful interference to radio or television reception, which can be determined by turning the equipment off and on, the user is encouraged to try to correct the interference by one or more of the following measures:

- Reorient or relocate the receiving antenna.
- Increase the separation between the equipment and receiver.
- Connect the equipment into an outlet on a circuit different from that to which the receiver is connected.
- Consult the dealer or an experienced radio/TV technician for help.

This device complies with part 15 of the FCC Rules. Operation is subject to the following two conditions:

- (1) This device may not cause harmful interference,
- (2) This device must accept any interference received, including interference that may cause undesired operation.

The device has been evaluated to meet general RF exposure requirement.

11.Specifications

ECOM14	Item	Electric Scooter
Dimensions	Tire	14 inch
Weight	Unfolded(Length x Width x Height)	55.7*22.4*47.2inch(141.5*57*120cm)
	Net Weight	57.1lbs(25.9kg)
Riding requirements	Load	220 lbs(100kg)
	Recommended Age	16-50 Years old
Main Parameters	Max Speed	22 Mph(km/h)
	Max Range	31 Mile
	Max Slope	15%
	Charge Temperature	32-113°F
	Discharge Temperature	-68-140°F
Battery Pack	IP Rating	IPX4
	Voltage	48V
	Max.Charging Voltage	54.6V
	Capacity	10Ah
Wheel Motor	Nominal Power	350W
	Max Power	450W
Charging adapter	Output Current	2A
	Output Power	50/60HZ
	Input Voltage	100-240V&50/60HZ
	Output Voltage	54.6V DC
	Charging Time	5-6hours

12.Instructions of Seat&Basket Assembly(Optional)

Attaching the Seat Cushion

Required Tools:10mm Wrenches(Included)

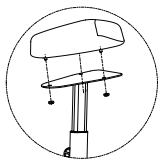

1. Unscrew nuts(E) under the seat cushion
2. Aim for the holes in the seat

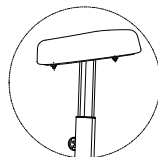

3. Tighten the nuts(E)

Adjusting the Height of the Seat

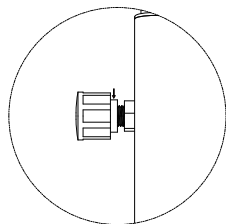

- 1.Loosen the knob to left

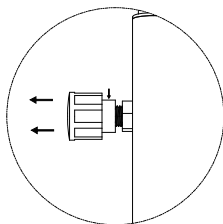

- 2.Pull the knob out

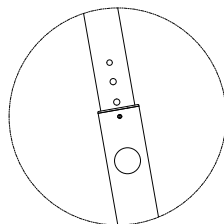

- 3.You can adjust the height of the seat

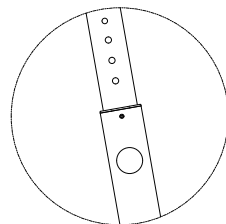

- 4.Tighten the knob to right

Attaching the Basket

Required Tools:3mm Allen Wrench(Included)

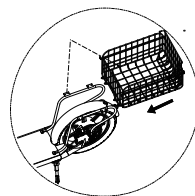

1. Unfold the basket

CAUTION: the basket will pop out, please press on the edge before opening the buckle

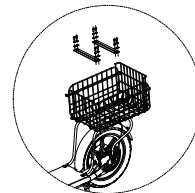

- 2.Tighten the screws(F)

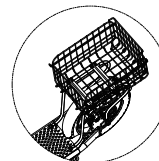

WARNING: Do not exceed weight limit of 33 lb (15 kg) on luggage rack.

Disassemble the Seat and Frame of Basket

Required Tools:4mm Allen Wrench(Included)

- 1.Unscrew the screws with the required tools.

⚠ Need Help? Please search "Hiboy us" on Youtube website to find our Channel. You can watch the Installation video of ECOM 14. Or contact Hiboy after-sale team by email: support@hiboy.com.

13. Limited Warranty Statement

30 DAY SATISFACTION GUARANTEED RETURN POLICY

If you are unsatisfied with your purchase, Hiboy's return policy allows you to return your undamaged Hiboy product purchased on the Authorization channel within 30 days counting from the date of receipt of shipment, and request a refund from the Authorization channel for any reason. Note: The cost of return shipping will be borne by the customer if the product has no quality issue.

For the return request, Hiboy is not responsible for lost packages due to the carrier, or products received that cannot be verified. Received products that have damage determined to have been caused by the end-user may be subject to denial of the return request.

TO QUALIFY FOR A REFUND, ALL THE FOLLOWING CONDITIONS MUST BE MET:

- 1.A Return Merchandise Authorization (RMA) must be requested from Hiboy within 30 days from the date of receipt of shipment. To request an RMA, contact Hiboy Service Team at support@hiboy.com.
- 2.The cost of return shipping will be borne by the customer.
- 3.For warranty service, please keep your receipt and/or invoice to validate proof of purchase.
- 4.Returned product must be in good physical condition (not physically broken or damaged).
- 5.All accessories originally included with your purchase must be included with your return.
- 6.If you return a product to Hiboy, (a) without an RMA from Hiboy(b) without all parts included in the original package, Hiboy retains the right to refuse delivery of such return.

LIMITED PRODUCT WARRANTY

Hiboy product basically will be free from defects in materials and workmanship under normal use for a period aforementioned. Hiboy does not warrant the operation of the product will be uninterrupted or error-free. Hiboy is not responsible for damage arising from failure to follow instructions relating to the product's usage.

REMEDIES

If a hardware defect is found and a valid claim is received by Hiboy within the Warranty Period, Hiboy will, at its option and to the extent permitted by law, either (1) repair the product at no charge, using new or refurbished replacement parts or, (2) replace the product with a new or refurbished product. In the event of a defect, to the extent permitted by law, these are your sole and exclusive remedies. Shipping and handling charges may apply except where prohibited by applicable law. This Limited Warranty is valid only in the jurisdictions where the products are sold by www.hiboy.com, and is valid to the extent permitted by the applicable laws of such jurisdictions. Any replacement hardware product will be warranted for the remainder of the original warranty period or thirty (30) days, whichever is longer, or for any additional period of time that may be applicable in your jurisdiction.

HOW TO OBTAIN WARRANTY SERVICE

A Warranty Service Order must be requested from Hiboy within Warranty Period from the date of receipt of shipment. To request a Warranty Service Order, contact Hiboy Service Team support@hiboy.com. To obtain warranty service, you must deliver the product, in either its original packaging or packaging providing an equal degree of protection, to the address specified by Hiboy. In accordance with applicable law, Hiboy may require the customer to furnish proof of purchase details and/or comply with registration requirements before receiving warranty service.period or thirty (30) days, whichever is longer, or for any additional period of time that may be applicable in your jurisdiction.

LIMITATION OF DAMAGES

Except to the extent prohibited by applicable law, Hiboy shall not be liable for any incidental, indirect, special, or consequential damages, including but not limited to loss of profits, revenue or data, resulting from any breach of express or implied warranty or condition, or under any other legal theory, even when Hiboy has been advised of the possibility of such damages. Some jurisdictions do not allow the exclusion or limitation of special, indirect, incidental or consequential damages, so the above limitation or exclusion may not apply to you.

14. Question & Answer

1. Is there any necessary information need to be included before contacting with Hiboy Support Team?

A: Yes, if you need any support from Hiboy, please contact us at support@hiboy.com, and please always include your order number, correct model No., descriptions of the problem, pictures, and videos that can show details about the issue in the email, thanks.

2. My scooter can't be turned on, what can I do?

A: First please make sure you are not turning on the scooter during charging, because for safety consideration, we have set the scooter can't be turned on during charging. Second please make sure the scooter has been charged for a while to have enough battery to support it can be turned on, otherwise please contact us at support@hiboy.com for further support.

3. I can't charge my scooter, what's the problem?

A: Please note if the scooter is charging, then the led on the charger will show red color, if the scooter is fully charged, then the led on the charger will show green color.

So please help to verify if the charger is defective first: Plug the charger into the socket but not connecting to scooter, if the charger led is NOT on or it is NOT green color, then it means the charger is defective.

If the charger is not defective, please contact us at support@hiboy.com for further support.

4. What if the E-Scooter arrived missing accessory or broken part?

A: Please take a photo and send to Hiboy Support Team's email: support@hiboy.com, Hiboy Support Team will reply you soon and send correct accessory or part replacement.

5. How to attach the seat?

A: Please refer to the assembly steps in this manual, and you can also search for "how to assemble Hiboy seat" on Google, and then you can find some Youtube tutorial videos.

6. Is that possible to replace some components for example the rear fender?

A: Yes, please take a photo and send to Hiboy Support Team's email: support@hiboy.com, Hiboy Support Team will reply you soon.

7. My scooter is stolen, can you help me?

A: I'm sorry we can't track on the location or serial number of the scooter, please call the local policeman and ask them for help.

8. I have written several emails to support@hiboy.com, but no responses received, why?

A: Our Hiboy Support Team will reply to you within 1 working day, if you didn't receive any reply from us, please also kindly check your spam box, and add support@hiboy.com on your whitelist to make sure our reply is not blocked. In addition, you can also contact us on the platform where you purchased the scooter for example Amazon chat box, leave message on hiboy.com website, eBay chat box...etc.

9. Why the speed can't reach 22/23 mph?

A: Within 220 lbs weight and ride on flat road can reach 22/23 mph speed easily. The Max speed is affected by many factors. The battery status, rider weight and road situation will also influence the max speed.

10. Why the max distance is lower than advertised max distance?

A: Please note the max distance is measured when it is no wind and at 77°F, the scooter's fully charged to ride at a even speed of 11.4 mph (18.4 km/h) on a at surface with a load of 165 pounds (75 kg). The real battery life vary with different factors of the load , humidity , wind speed and operation habits...etc.

11. Can I ride the scooter in the rainy days?

A: Kindly note the scooter waterproof level is IPX4, we don't suggest you to ride it in the rainy days.

12. Is there any caution for storing the scooter if I need to go out for a long time vacation?

A: Please make sure the scooter is stored in a dry & cool place, do not put it outdoors for long time, and if the scooter is expected to be left idle for more than 30 days, please fully charge the battery, keep in mind to recharge it every 60 days to protect the battery from potential damage which is beyond limited warranty.

Trouble shooting

Error code	Error description	Solution
E1	Motor Hall Error	Need to check if the motor hall cables are connecting well first, if any cable is not connecting well, re-connect it and see if the E1 error disappears;After re-connecting the haul cables and E1 still exists, then need to replace the motor.
E2	Brake Error	Check whether the contact switches of the left and right brake bars cannot return to the position. If they cannot return to the position, please replace the brake bars. (Brake handle fault will only be detected when starting up)
E3	There is problem for the communication between the top display and controller inside the frame	Need to replace the top display PCB and the display-controller connection cable
E4	Over current protection, when E4 appears, both electronic brake and throttle will stop working	Normally the E4 will disappear automatically after cool down the scooter for a while, if the E4 continues to show up frequently, then need to replace the controller
E5	Low voltage protection, when the battery voltage is lower than 30V, it will show up E5	First charge the scooter and see if E5 disappears, if E5 doesn't disappear after charging, then need to replace the battery
E6	There is problem for the communication between the top display and controller inside the frame	Check whether THE communication assembly line between the top display and the controller is loose or the communication line is torn off. Replace the controller and the top display
E8	Controller Error	Need to replace the controller
E9	Motor Stuck Error	Turn the motor wheel by hand to see if the motor is stuck. If the motor is stuck, replace the motor with a new one.

15. Contact Us

Contact us if you experience issues relating to riding, maintenance and safety, or errors/faults with your Hiboy ECOM14

E-mail Service: support@hiboy.com



@Hiboy_Official



HiboyUS



@HiboyUS



www.hiboy.com