

RM03

TOUCH SCREEN STREAMING
VIDEO REAR VIEW MIRROR

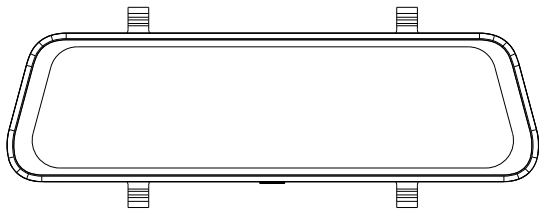

If you have any other questions or problems, Please feel free to contact us at

DC@yoomail.com

We have professional team at your service, and your satisfaction is guaranteed.

Important Notice:

- **NOTICE : Due to the high power consumption of this unit, it should always be connected to an external power supply. This unit will not power on without external power supply.**
- This product is intended for use in motor vehicle only. Do NOT install the device where it might block the driver's view of road (including the mirrors) or the deployment of the airbag.
- Before using this device, please insert the memory card first, and need to format micro SD card to FAT32 format on PC firstly, then format the memory card in camera menu.
- This device records video at high resolution, Be sure to use high speed memory card, Class 10 or above is recommended, 16GB or 128GB cards are recommended.
- We do recommend doing a benchmark test and make sure the unit is working perfectly before installing the unit on your vehicle.
- Be sure the lens is clean and there is nothing blocking the lens.
- Make sure you are using the original included power adapter to power the unit.
- DO NOT leave the device in direct sunlight for a long period of time or where the temperature could go above 170°F(75°C).
- The GPS function has to work with the customized GPS module, please download "GXplayer". (Please contact the seller for details.)

Installation Guide

1. Before installation, please insert a high speed memory card in the unit and format the memory card in the unit setting, also do a simple test to make sure the unit is working perfectly.
2. Mount the mirror over the original rearview mirror and use the included rubber ring to fix it. Make sure the mirror is in the right place and secured.
3. Adjust the mirror angle according to your driving position, make sure the mirror is right in place and the view is clear.
4. Adjust the angle of the lens. Make sure you get best coverage over the hood and the road ahead, so you can record what happens.
5. Connect the power adapter to the mirror and the cigarette lighter, then route the power cable along the interior trim board, you can route it as indicated below, and hide the excess cable in the gaps for good looking.



6. The rearview camera should be installed at the rear end of the car, normally the best place is above the number plate. The camera can be fixed with the sticker or the screw. You can see the diagram for reference.

(**Note:** Please check whether the backup camera is installed upside down before you install screws.)

7. The excess RED lead near the rear view camera is used for reverse status sensing. Connect the RED cable to the positive lead of the reverse lamp power.

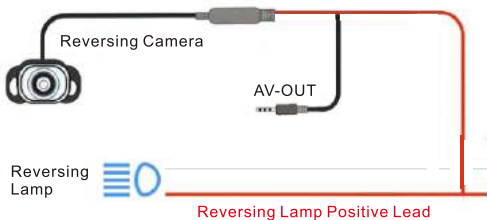

8. Route the backup camera cable to the front of the car and connect it to the main unit. There are 2 pictures for reference. (**NOTICE:** Holes might need to be drilled to pass the cable and please check whether the cable for backup camera is long for your car before you install it.)



Wiring Method A



Wiring Method B

9. After the installation is completed, please start the engine and have a test run, make sure all functions are working.

NOTICE: The wiring and the installation requires certain hand work and some professional electrician skills, if you are not sure about it, please get some professional help.

Adjust the Reversing Camera

Adjust the reversing camera angle, the best angle is the the camera can cover the rear of the car and the ground surface under the rear end.

Notice:

When the car is in reverse, the rear camera will automatically display in full screen, and turn to the lowest angle, so you can see the ground surface under the rear end while reversing.

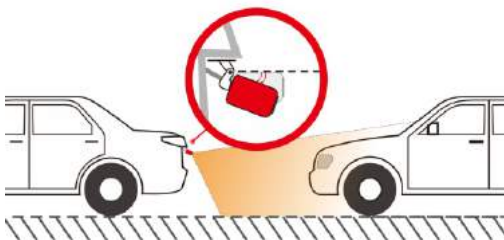

Interface and Button Functions

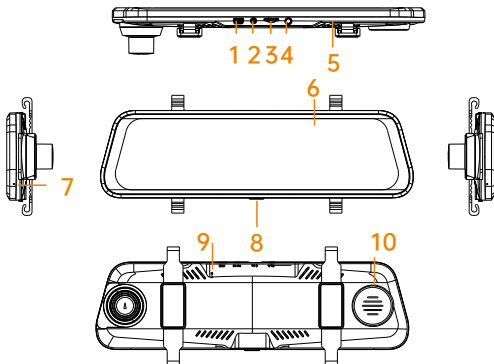

- 1.Power interface (mini USB)
- 2.Av-in rear camera interface、
- 3.Micro SD card slot
- 4.3.5mm middle camera interface
- 5.Fixing strap hook
- 6.IPS HD display
- 7.Mic recording hole
- 8.Power key (long press for 5seconds to restart)
- 9.Engineering upgrade hole
- 10.Horn











1. It will automatically stop recording and save the recorded video file.

2. 2.5mm AV-in rear camera interface: connect the standard 2.5mm4 section headphone base rear camera extension cable.

3. Micro SD card slot: insert the micro SD card and the video files will be stored on the micro SD card. Use of memory card: please determine the insertion direction of micro SD card. If the insertion direction is incorrect, the machine and the micro SD card may be damaged: please use a high micro SD card conforming to SDHC specification. For this product, please use an authentic micro SD card marked above class10. Support 8 ~ 128G.
4. Middle 3.5mm camera interface: connected to middle camera.
5. Fixing strap hook: it is used to fix the rear view mirror to the original rear view mirror and cooperate with the strap.
6. IPS HD display screen: display the camera preview image. Note that the protective film is pasted at the factory. Please remove it when using.
7. Recording hole: there is a recording microphone in this hole, which is used for recording during video recording
8. Power key (long press for 10 seconds to restart)
 - A. On/ off function In the shutdown state, press and hold the power key for 3 seconds to turn on the power of the machine. In the power on state, press and hold the power key for 3 seconds, and the machine will automatically save video files and shut down;
 - B. Turn off the display backlight In any state, short press the power key to sleep, turn off the backlight, and short press the power key again to light up.
9. Engineering upgrade hole: used to upgrade the system.
10. Loudspeaker: the key tone of operating the machine and the sound of playing back the video file of the recorder.

Main interface



- A. Clicking  indicates that there is sound in the video recording, and the red slash  in the recording icon indicates that the video recording is silent.
- B. Click  to switch the preview images of front, rear and middle cameras, or slide the screen left and right to switch.
- C. Click  on the video playback.
- D. Click  a small red dot to indicate that the video has been recorded, and no small red dot turns into a white  dot to stop the video.
- E. Click  the photo icon capture the photo.
- F. Click  the icon indicating that the video is unlocked  indicating that the video has been locked, and the recording time will change from red to yellow.
- G. Click  to enter the setting-related functions.
- H. Slide the brightness bar to adjust the brightness of the screen backlight.



Main interface

Slide the screen left and right or click the switch button to switch the front camera preview picture, the middle + rear camera preview picture displayed on the same screen, the rear camera preview picture, the middle + rear + front camera preview picture displayed on the same screen, and the four preview pictures can be switched in a cycle.

1. Front camera preview screen. Dragging the screen up and down under the front camera preview screen can adjust the display range of the camera screen on the screen, and the adjustment screen will not affect the actual picture range of video recording.



2. The middle road + rear camera preview screen is displayed on the same screen.



3.The rear camera preview screen. Dragging the screen up and down under the rear camera preview screen can adjust the display range of the camera screen on the screen. The adjustment.screen does not affect the actual picture range of video recording.



4.The middle road + rear camera + front camera preview screen is displayed on the same screen.



Video playback

You can view video sand pictures recorded before and after.Click the preview interface to lock,play,delete and other related functions.



Setup

You cannot enter the setting when recording. You can only enter when recording is stopped do.



Video mode:

Loop recording:

set the duration of video segmentation: 1 minute, 3 minutes and 5 minutes. It is 1 minute by default

Night scene mode:

the user can turn on or off to change the number of frames of the video according to the incoming brightness at night, so as to make the brightness of the video and screen display reach the effect of starlight level. It is turned off by default.

The recording:

video recording switch, which can turn on and off the video recording function. It is turned off by default.

Parking monitoring:

turn on the parking mode in the menu. When the recorder is turned off, it is vibrated. The recorder can sense it according to G-sensor, automatically start the machine and record for 30 seconds, and then turn it off. When the parking mode is not turned on, the recorder will not start when it is vibrated (This file will be locked. and the locked image will be saved as a special file, which will not be overwritten.) Off by default.

General settings:

Clicking sound:

the user can run on or off the key feedback tone, which is turned on by default.

Volume:

you can set the driving record on-off sound and key tone of operation, and select relevant, high, medium and low, which is medium by default.

Language:

the user can select the language as required. The machine supports simplified Chinese, English, traditional Chinese, Japanese, etc.

Flicker:

set the corresponding flicker frequency according to different light source frequencies, including 50 Hz and 60 Hz. The default is 60 Hz.

LCD Auto shuts down:

1 minute. 1 minute. 3 minutes and 5 minutes can be set. It is closed by default.

Gravity induction:

the machine has a built-in collision sensor (G-sensor). In case of serious vehicle collision. the recorder will lock the current image data at the time of the accident, and the unlock icon at the bottom of the display screen will automatically change to lock; The locked image will be saved as a special file, which will not be overwritten circularly.

Rear mirror:

off by default. If on is selected, the rear preview is the original image. Note: it should be a mirror image when reversing.

Middle mirror:

turns on or off the middle route preview image. It is off by default..

Clock settings:

the user can click Reset to set it. [note] in order to effectively record the date and time of obtaining evidence of driving safety accidents, please set the correct time immediately before using the machine.

Date format:

date display formats include mm/ DD /yyyy, mm/ DD /yyyy and mm / DD/yyyy.The default format is mm/DD/yyyy.

Time format:

you can select the time system of 12 hours and 24 hours. The default is 24hours.

Reset default setting:

clicking restore factory settings will prompt whether to restore factory settings, confirm and cancel.

Format TF - Card:

with this option, you can format the micro SD card and back up important data regularly. Formatting the micro SD card will delete all files in the micro SD card and cannot be recovered. Please operate carefully and make a backup. Please format the micro SD card regularly. If it is used for a long time, the recorder will stop recording because the locked file will not record circularly, resulting in an insufficient capacity of the recorder. It is recommended to format once every 1-2 weeks

FW version:

you can view the information related to the system version number.

Specification:

Modell	Rm03
Screen Display	10 inch (9.66 inch)
Screen Resolution	1280 * 320
Lens	Front and Rear Wide Angle Lens
Video Resolution	Front: 1920*1080P Rear: 1280 * 720P Middle : 1280 * 720P
Video Format	TS
Video Encode	H.264
Image Format	JPG
Loop Recording	Built-in
Parking Monitor	Built-in
G-Sensor Lock	Built-in
Microphone	Built-in
Speaker	Built-in
Storage	Micro SD Card Up to 128GB (NOT included)
Operating Temperature	-20~60°C
Storage Temperature	-30~70°C
Operation Humidity	15~85%RH
Power Supply	DC 5V / 2.5A

Common Problem and Solution

Recorder shows memory full, unable to loop video, etc.

1. First, when a new memory card is used for the first time on the machine. Please format the memory card to FAT32 format on PC then format it in the camera.Or the memory card is previously used on another type of device,it needs to be formatted when used on this camera.Or change another new SANDISK 32G Micro SD CARD.

2.Check the sensitivity of G-sensor, If the sensitivity is too high,the bumping and shaking of the camera will trigger the G-sensor,and the file will be locked. Locked files cannot be overwritten.If the lock file is accumulated, there will be no memory card to loop record. When parking monitoring is turned on, shaking will also cause too many stray files, which will also affect the reading and writing of cards.)

The device will automatically turn on or turn off.

1.Please format the memory card to FAT32 format on PC then format it in the camera.

2. Please check whether the parking monitoring function is on.With parking monitor on, the device will automatically turn on and record when it detects a collision or shaking.

3. Check the car charger connection status, if the connection is loose, the power supply is not stable, the camera will automatically turn on and off.

The rear camera does not display image

1. Please switch the camera display mode to double check the rear camera status.
2. Please check if the AV plug is properly connected and the cable is plugged in correctly.
3. Try to disconnect the camera and clean the connector with some Medical alcohol connect it again.

Screen operation or button reaction is slow during recording

1. Please check whether the memory card used is a high-speed card (Class10), If you use a non-high-speed card, problems such as missed seconds, video playback jams, screen display Colorful stripes, and crashes may occur.
2. Reset the camera if necessary.

Change in the setting menus won't save.

1. After change settings, please manually press the Power button to shut down, and the device settings will be saved.
2. When the device is abnormally powered off, the unit might not save the settings.
3. When the battery is too low, the customized settings might be lost.

Even though set the screen saver, but the screen will randomly come back on.

The power supply might not be stable, please change another car charger to try.

