











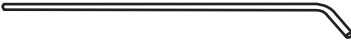





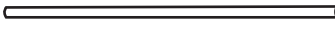
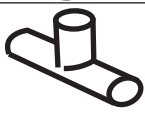

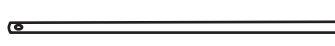

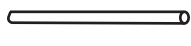

# Assembly Instructions

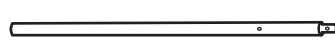
ITEM	PHOTO	QTY	ITEM	PHOTO	QTY
1#		4	A		6
2#		4	B		14
3#		2	C		6
4#		20	D		4
5#		25	E		6
5a#		2			6
5b#		4			1
6#		12			10
7#		2			4
7a#		2			4
8#		2			1
8a#		2			1
9#		3			

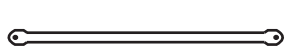
## Attention:

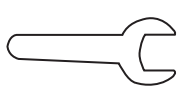
1. Please secure your greenhouse in windy conditions with extra ropes when wind speed excess 24 miles/hour.
2. Please try to install your greenhouse away from direct wind conditions.
3. Please keep your greenhouse clear of snow during snowy conditions. Snow coverage can not be exceeded 2inch.
4. We will not accept any responsibility due to greenhouse damaged by severe weather.

1

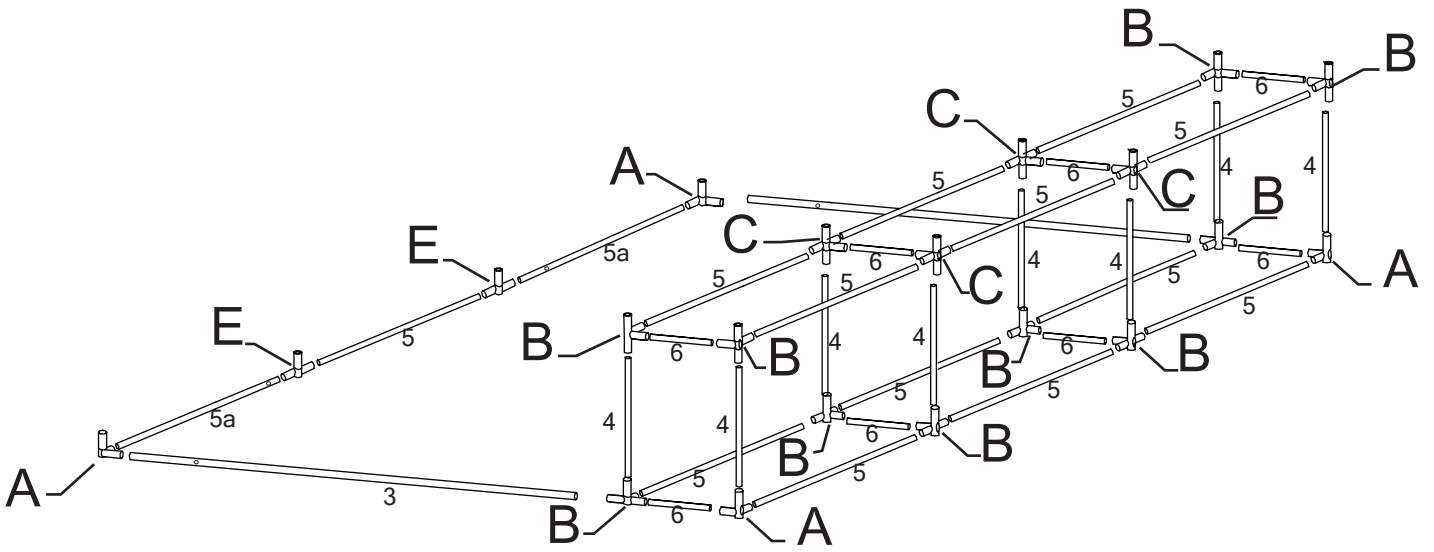

2

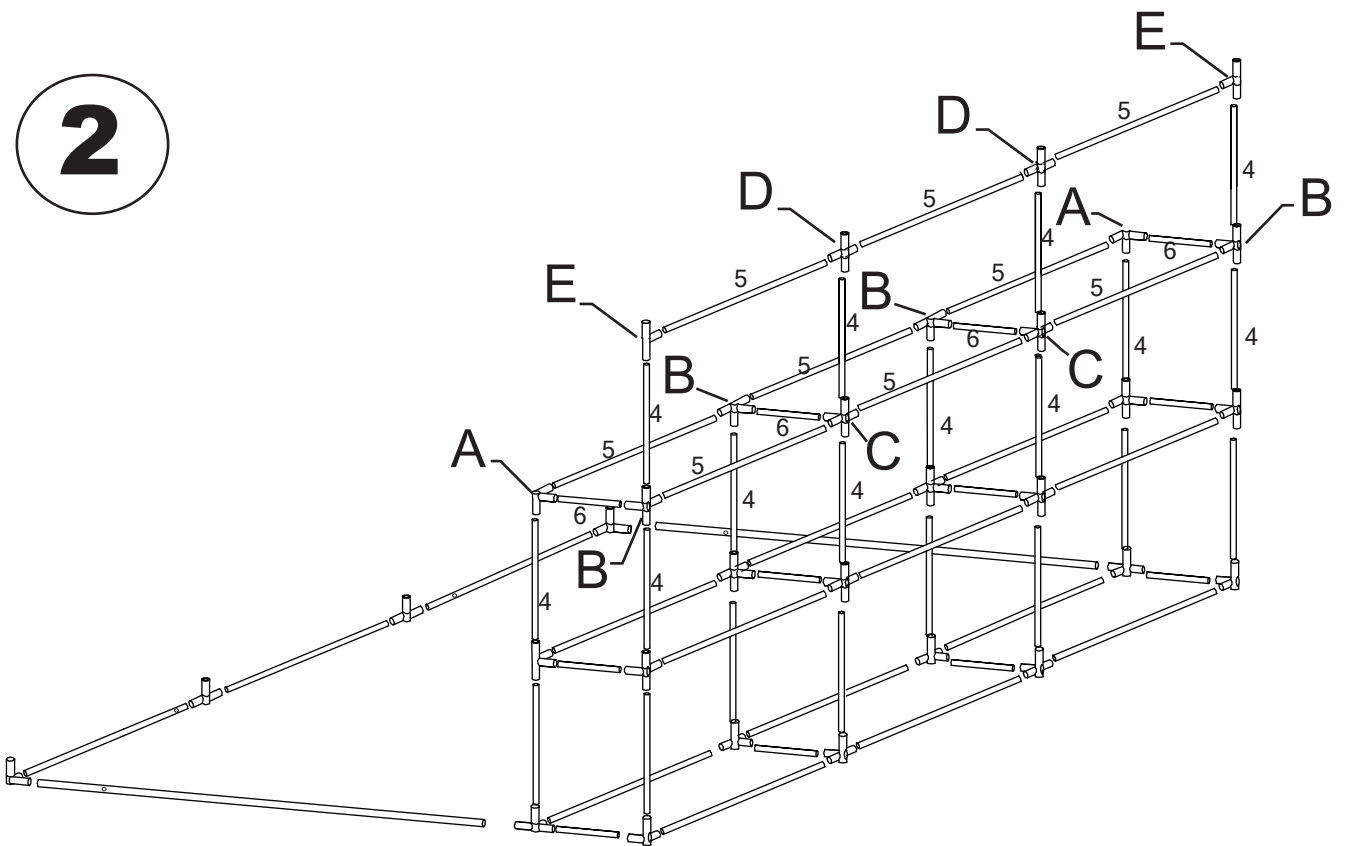

**3**

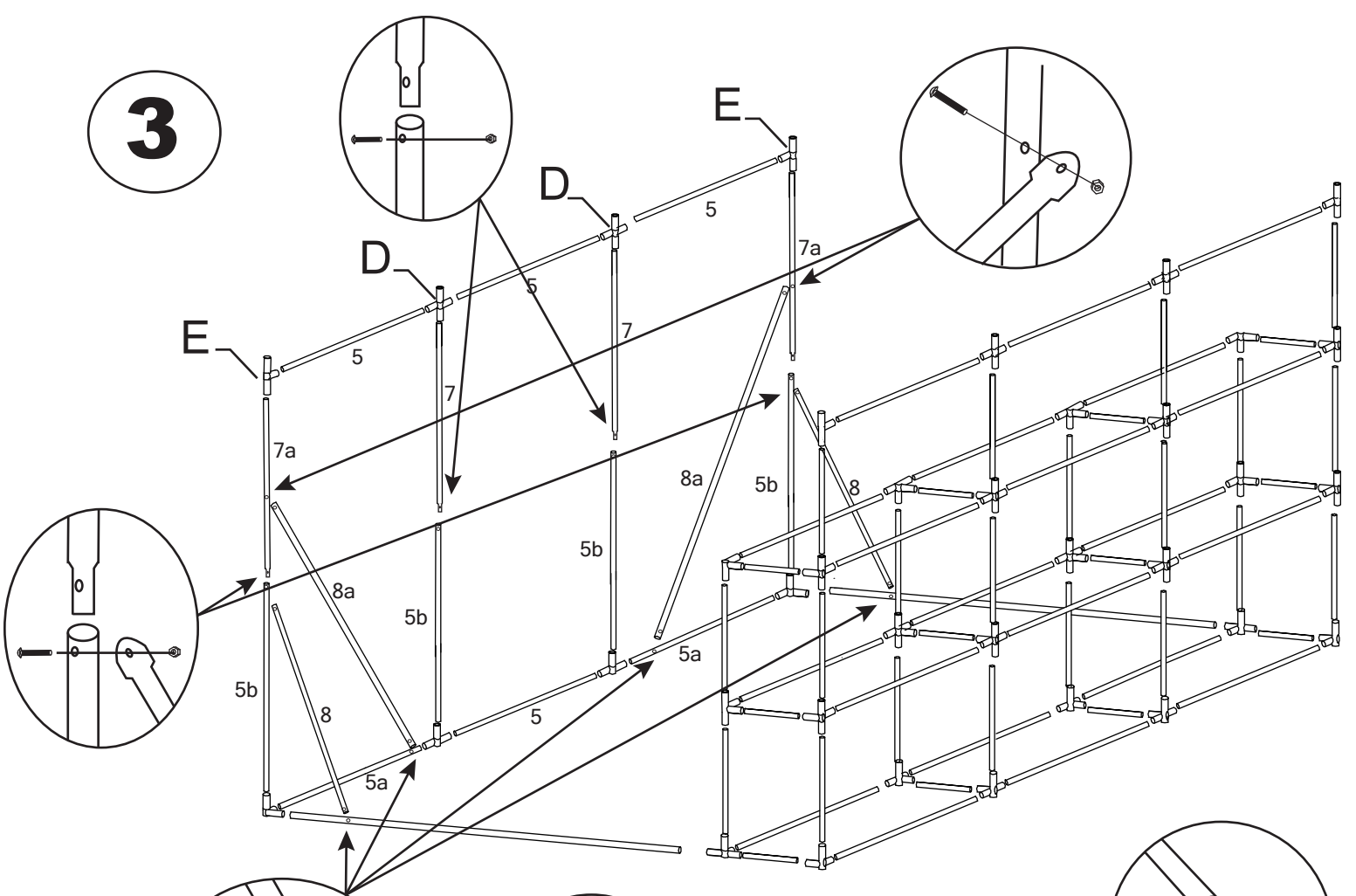

**4**

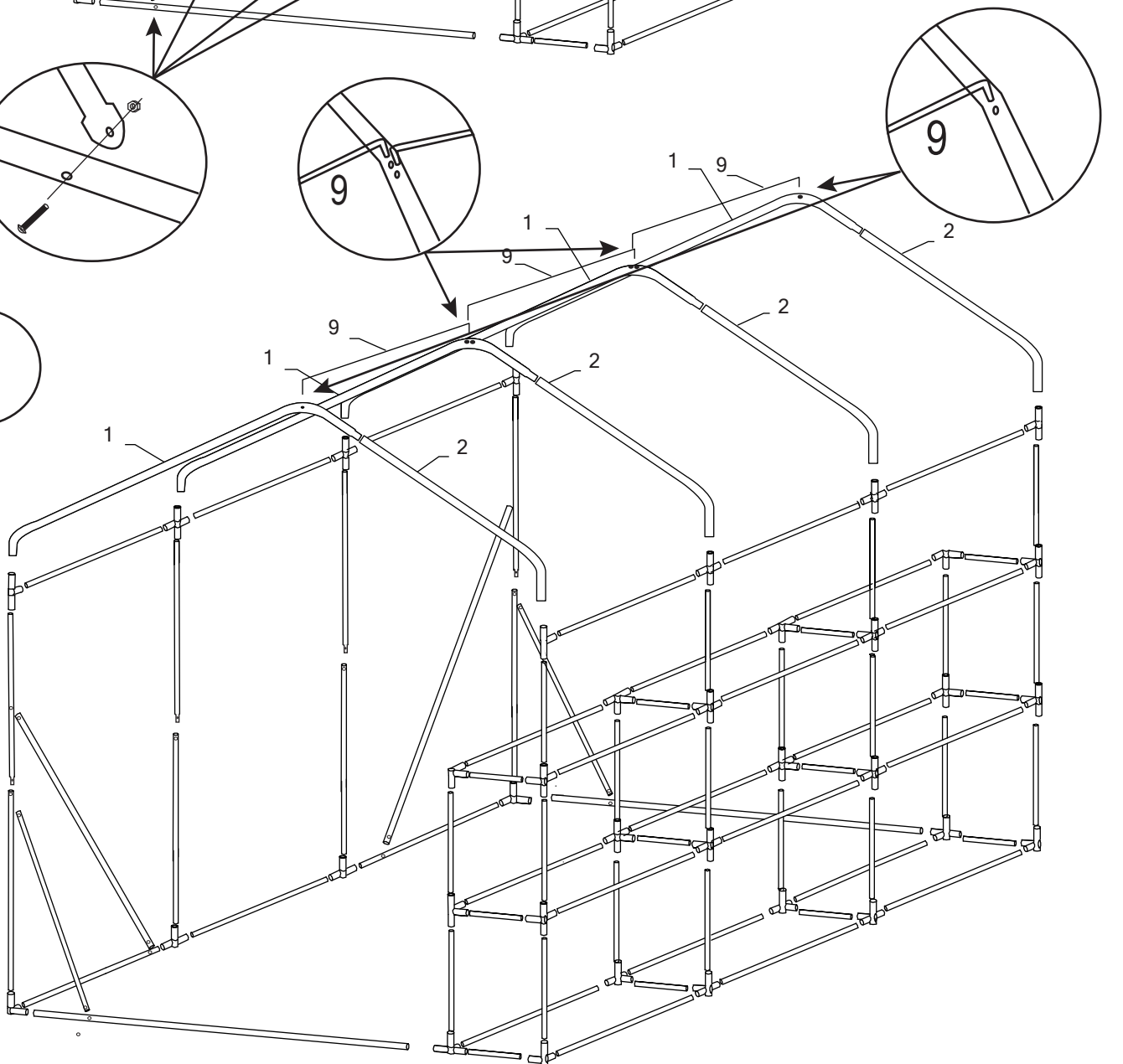

**5**

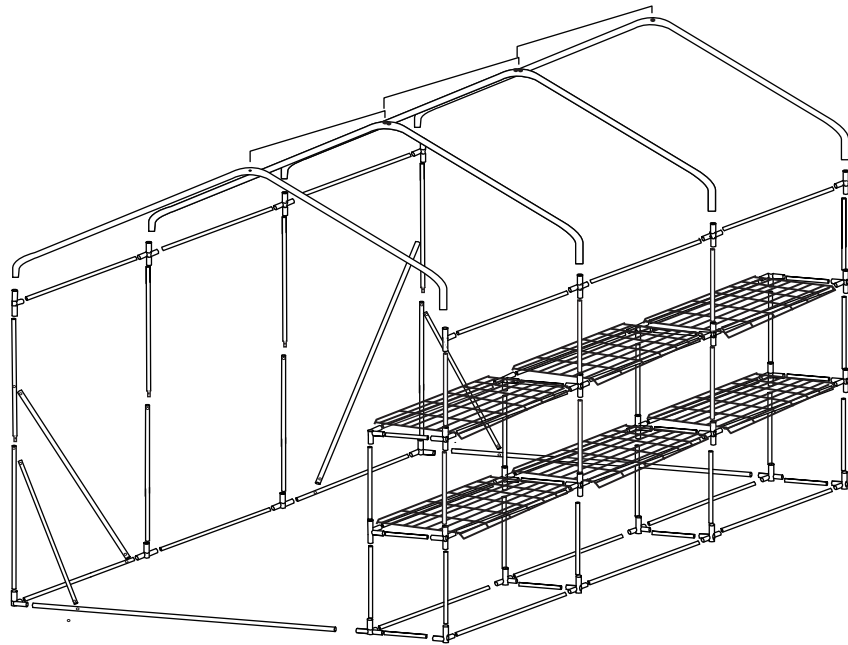
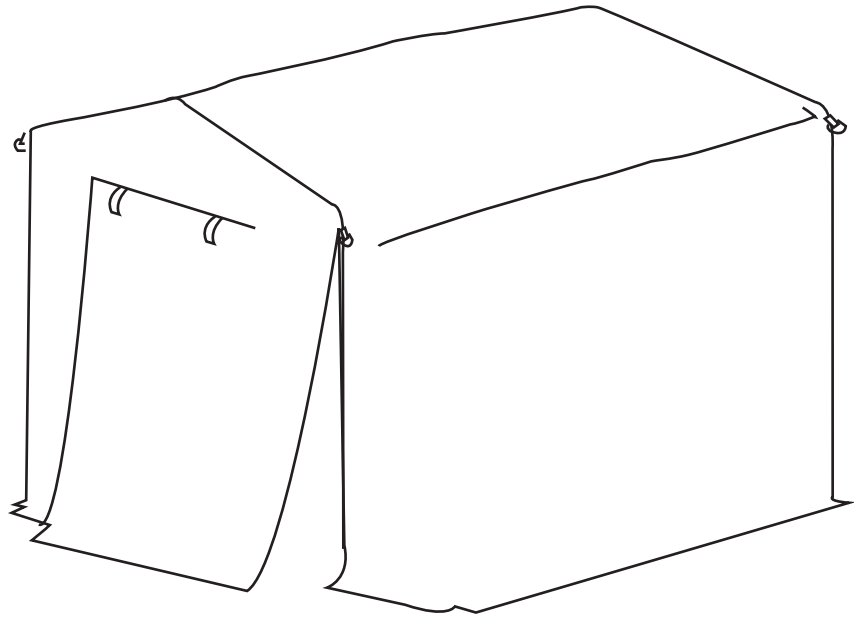

**6**

