

## Setting The Recording Level Correctly

Camera devices generally have poor-quality, noisy preamps. In order to get the cleanest signals possible, it is highly recommended that you set the recording level on your camera quite low, 1/2 or 1/3 of it. G2 provides variable gain control, allowing you to tailor your levels to just about environment and recording device.

Adjust the recording level of inbuilt mics for SONY Camera (Take A7S II for example)

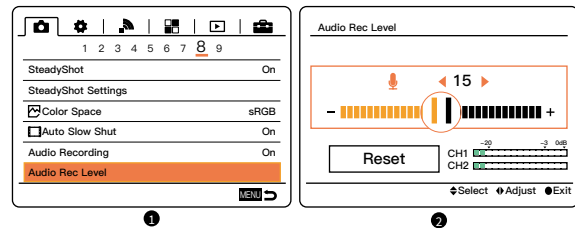

Adjust the recording level of inbuilt mics for Canon Camera (Take EOS 5D Mark IV for example)

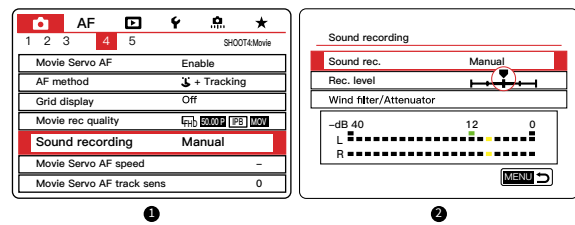

Adjust the recording level of inbuilt mics for Panasonic Camera (Take LUMIX GH5 for example)

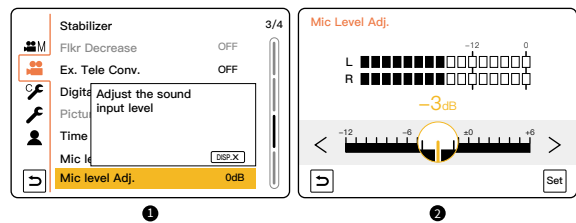

## Specifications

### TX Transmitter

Wireless Transmission	Digital 2.4GHz
RF Frequency Band	2400-2483.5MHz
Working Distance	492ft/150m(LOS area), 164ft/50m(NLOS area)
Mounting	Pocket Clip
Audio Input	1/8" / 3.5mm TRS Mic Input
Audio Input Level	1V (0dBV)
RF Output Power	<10mW
Power Requirements	3.3V-4.7V
Battery Type	Built-in Lithium Battery, 400mAh
Battery Charging Time	1.5H
Battery Life	8H
Display	TFT Screen
Dimensions	52×42×17mm
Material	Plastic
Weight	39g

### RX Receiver

Wireless Transmission	Digital 2.4GHz
RF Frequency Band	2400-2483.5MHz
Approximate RF Sensitivity	-81dBm
Working Distance	492ft/150m(LOS area), 164ft/50m(NLOS area)
Mounting	Pocket Clip
Number of Audio Channels	1
Audio Output	1/8" / 3.5mm TRS Mic Output 1/8" / 3.5mm TRS Headphone Output
Gain	0-5 Level
Audio Output Level	Line Out: 1V; Monitoring: 25-30mW
Power Requirements	3.3V-4.7V
Battery Type	Built-in Lithium Battery, 400mAh
Battery Charging Time	1.5H
Battery Life	8H
Display	TFT Screen
Dimensions	52×42×17mm
Material	Plastic
Weight	39g

### Microphone

Form Factor	Built-in/External Mic
Sound Field	Mono
Polar Pattern	Omnidirectional
Frequency Range	50Hz-20KHz
Sensitivity	-40dB (±3 dB, re 1V/Pa at 1KHz)
Maximum SPL	135dB SPL (at 1KHz)

## Warranty

### Warranty Period

Thank you for purchasing SYNCO products.

- Customers are entitled to free replacement or repair service in case of quality defect(s) found in the product under normal use within 30 days upon receipt of the product.
- Original SYNCO products are entitled to 12-month limited warranty service. The warranty period begins on the date of purchase of brand new, unused products by the first end-user.

Within the warranty period, if product defect or failure is attributable to material defection or technological problem, the defective product or defective part will be repaired or replaced without charge (service and materials fee).

### Warranty Exclusions and Limitations

- Faults resulted from inappropriate use of a product without following its operation specification
- Artificial damage, e.g. crash, squeeze, scratch, or soaking
- Modifications to a product by its user or a third party without prior written consent of SYNCO, e.g. replacement of element or circuit, label alteration
- The code on product is inconsistent with that of warranty certificate, or the code on the product or warranty certificate is altered or torn off
- All consumable accessory attached to a product, like cable, wind muff, battery
- Faults as a result of force majeure, such as fire, flood, lightning, etc.

### Warranty Claim Procedure

- If failure or any problem occurs to your product after purchase, please contact a local agent for assistance, or you can always contact SYNCO's customer service through email at [support@syncoaudio.com](mailto:support@syncoaudio.com).
- Please retain your sales receipt and warranty certificate as proof of purchase. If any of these documents is missing, only sales return or chargeable service will be provided.
- If the SYNCO product is out of the warranty coverage, the service and the parts cost will be charged.

### Guangzhou Zhiying Technology Co., Ltd

Block 15th, No.200 Fangcun Avenue East, Liwan District, Guangzhou, China, 510000  
[support@syncoaudio.com](mailto:support@syncoaudio.com)  
[www.syncoaudio.com](http://www.syncoaudio.com)  
<https://www.facebook.com/syncomicrophones>

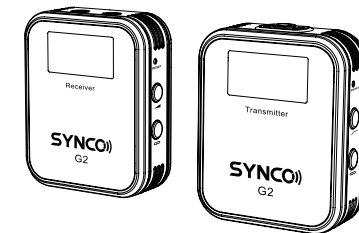

Microphone G2(A1) >>> User Manual

Thank you for choosing SYNCO product.  
 Please read this manual carefully before use and follow all instructions mentioned herein.

WARRANTY CERTIFICATE	
Please register your warranty. Meanwhile, you are welcomed to contact us via Email: support@syncoaudio.com	
USER INFORMATION	Customer Name:
	Phone Number:
	Email:
	Address:
SALES INFORMATION	Sales Date:
	Model:
	Product Code:
REPAIR RECORD	Dealer:
	Service Date:
	Technician:
Issue:	

RESULT  Solved  Unsolved  Returned(Replaced)

### Caring For Your SYNCO Product

- Please keep the product in a dry, clean, dust-free environment.
- Keep corrosive chemicals, liquids and heat source away from the product to prevent mechanics damage.
- Use only a soft and dry cloth for cleaning the product.
- Malfunction may be caused by dropping, impact of external force.
- Do not attempt to disassemble the product. Doing so voids warranty.
- Please have the product checked or repaired by authorized technicians if any malfunctions happened.
- Failure to follow all the instructions may result in mechanics damage.
- Warranty does not apply to human errors.

### Package List

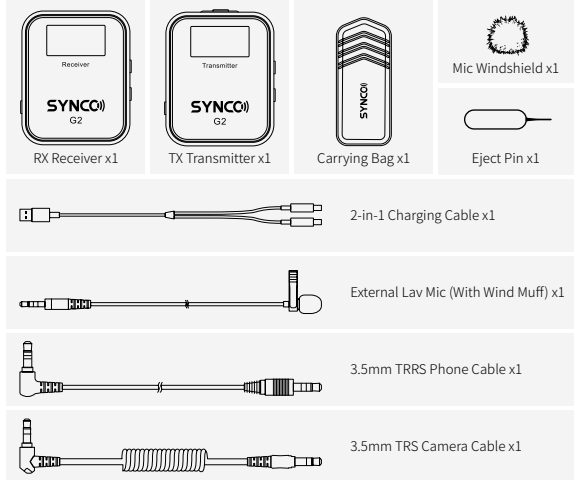

### Product Instruction

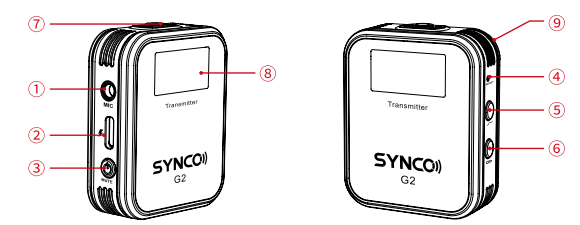

- TX Transmitter**
- ① External Mic Input
  - ② USB-C Port
  - ③ Power(MUTE)
  - ④ Reset(Help with Eject Pin)
  - ⑤ Low Cut
  - ⑥ Pairing
  - ⑦ Built-in Mic
  - ⑧ Display Screen
  - ⑨ Pocket Clip

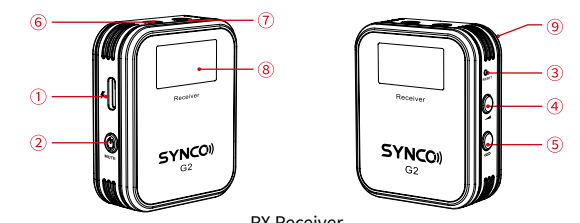

- RX Receiver**
- ① USB-C Port
  - ② Power (MUTE)
  - ③ Reset(Help with Eject Pin)
  - ④ Gain Control
  - ⑤ Pairing
  - ⑥ 3.5mm Audio Output
  - ⑦ 3.5mm Monitoring Jack
  - ⑧ Display Screen
  - ⑨ Pocket Clip

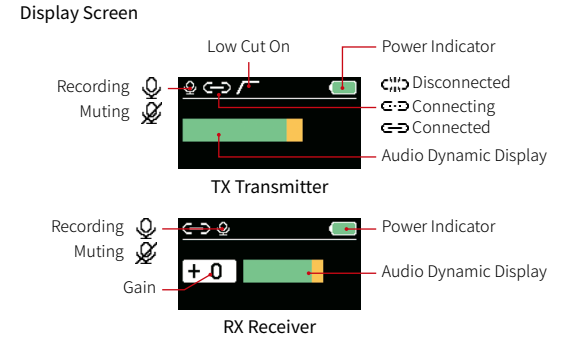

### Operations

- TX**
- 1.Power/ Mute**  
 Long Press 2s: turn on/off the system  
 Short Press: mute/unmute the microphone
  - 2.Charging**  
 5V/2A;with USB-C Charging Cable  
 Please fully charge the product before use.
  - 3.External Mic Input**  
 TRS Mic Only  
 (Note: When using a external mic, please insert it into the mic input properly.)

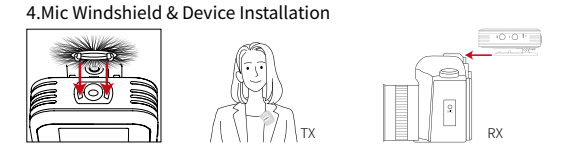

- 5.Reset**  
 Eject Pin

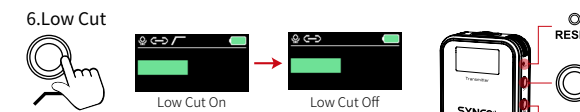

Short Press: 150Hz Low Cut On  
 Short Press again: Low Cut Off

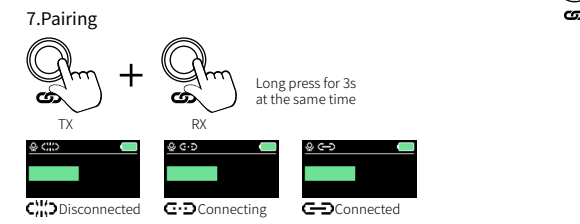

The system will pair automatically after power on.  
 Manual pairing: long press the pairing button on the RX and TX for 3 seconds at the same time

- RX**
- 1.Power/ Mute**  
 Long Press 2s: turn on/off the system  
 Short Press: mute/unmute the microphone

- 2.Charging**  
 5V/2A;with USB-C Charging Cable  
 Please fully charge the product before use.

- 3.Reset**  
 Eject Pin

- 4.Gain Control**  
 0-5 Level(0→3→6→9→12→15→0)  
 Each press increases gain by one level.

- 5.Pairing**  
 TX + RX  
 Long press for 3s at the same time



The system will pair automatically after power on.  
 Manual pairing: long press the pairing button on the RX and TX for 3 seconds at the same time

