

YOSE POWER



E-bike Kits User Manual

For Front Motor with Front Light

Appreciate for purchasing YOSE POWER electric bicycle Kits

Please turn to page 2 to obtain the user manual in English.----- 02

Vielen Dank für den Kauf des Yongsheng Elektrofahrrad-Kits

Um das deutsche Handbuch zu lesen, gehen Sie bitte auf Seite 9 ----- 09

Merci d'avoir acheté les e-bike kits de YOSE POWER

Pour lire le manuel en français, veuillez vous rendre à la page 17 ----- 16

Gracias por comprar el kit de bicicleta eléctrica YOSE POWER

Para leer el manual en español, vaya a la página 24 ----- 23

When you install the product, please make sure that you observe all instructions provided by the user manual. It is suggested that you use all components provided by yosepower. Serious injuries may be incurred due to damaged screws or because the nuts suddenly malfunction.

- Please make sure that you wear a goggle or other eye goggle device when you are repairing the bike or replacing components.
- If the content of the user manual does not include your product, please browse the official website – www.yosepower.com, or contact the yosepower team.
- Please put the user manual in the proper place for reference in the future.

Notices of user manual

Please add the following items when our system users provide the descriptions written by themselves :

- Please do not pay too much attention to the screen of the E-Bike display when you are riding the bike, or accidents may be incurred.
- Please do check the wheels sets and the tires are correctly installed on the bike. Serious injuries may be incurred if you fail to confirm that these components are correctly installed on the bike. or contact the yosepower team for assistance.
- When you are riding the E-Bike, you should be very familiar with the characteristics of the bike being activated or deactivated.
- If the bike is suddenly activated but you are not familiar with these characteristics, accidents will be incurred.
- Please turn on the light if you ride the bike at night or in the place without sufficient light provision.

Important information

- Please observe the safety instructions of the user manual for your safety.
- When using the product, please observe the safety instructions provided by the safety inspector or the user manual, the product is not suitable for mental disabled, physical disable or people without bicycle riding experience and relevant knowledge, including children.
- Please do not modify the system. The system will be out of order if you improperly modify the system.
- Please contact for help about the installation and the adjustment of the product yosepower team.
- The product is designed to be have the completely water-proof function and can be safely used in moist places. However, please do not immerse the product into water on purpose.
- Please do not use high-pressure water jet to wash the bike. If water contacts the components, the bike will be out of order and the components will be rusted.
- Please handle product with care to prevent from serious impact.
- Some safety instructions of the user manual can be also seen in the relevant warning marks on the product.
- Please contact yosepower for any questions about maintenance team.
- Abrasion due to normal use is not within the warranty range provided by us.

E-Bike assembling & repair guide

- Please remove the battery before you install the components and the cables of the E-Bike in order to prevent from accident.
- When you install the E-Bike, please make sure that you observe all instructions of the user manual. If the screws and nuts are not correctly tightened or the components are damaged, the E-Bike may fall over and serious injuries may be incurred.
- The frequencies of maintenance and repair will be different according to the usage situation of the E-Bike. The system of the bike should be periodically cleaned by the proper cleaning products. If you need to clean the bike, please use a neutral detergent and soft cloth or low-pressure water jet to wash the bike, and the dry the bike. Please properly use the suggested oils to lubricate the rotational components.

English

Tools and Packing Components

Installation tool	Material	
Adjustable wrench	Hub motor with wheel	
Cross screwdriver	Waterproof connection cable (5 in 1)	
Hex wrench	Controller (integrated inside the battery holder)	LCD display
Puller	PAS Sensor	Controller bag/box
	Thumb throttle	Brake lever
	Front Led Light	

Kits connection diagram(with battery)

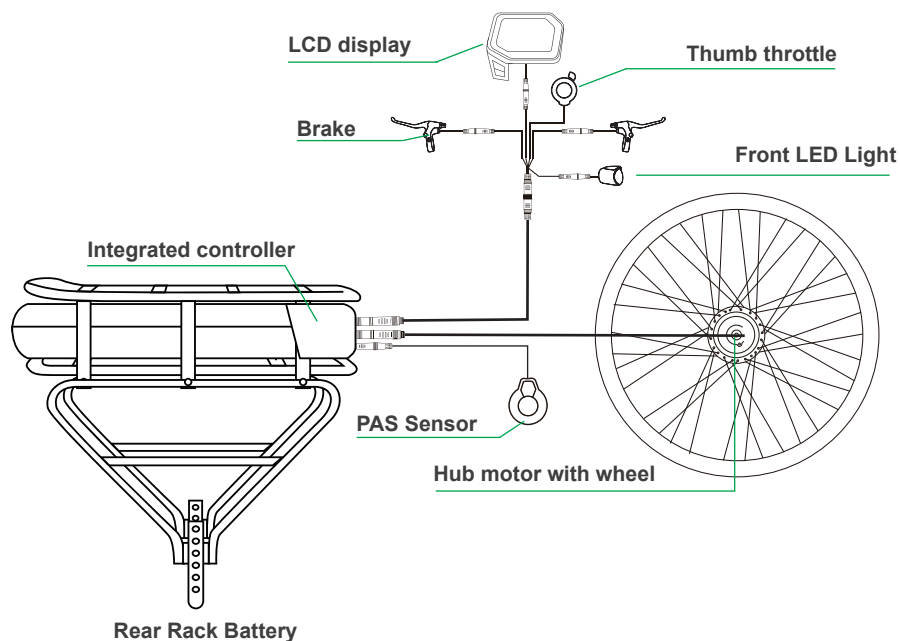
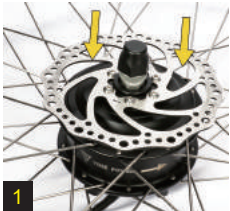



Photo 1,2: Take out the original front wheel.

Brake disk/Tire installation

- Photo 1: Unscrew the original brake disc and then install it on the motor with the hex wrench (**Attention: Please use the screws from the motor to fasten the disc**).
- Photo 2,3: Remove the original tire and guard ring, install them on the motor wheel (**The guard ring can protect the tire**).
- Photo 4: Install the original tire to the motor hub.



- Motor screws install and fasten method
- Photo 1: Place the washer (**with part bulge**), shim, and nut in sequence into both sides of the motor axle.
- Photo 2-3: Put the front wheel into the front fork, place the washer between the motor and fork, then use the adjustable wrench to fasten the nut. Please note: the motor cable should face down, cover the waterproof plug, waterproof and dustproof.

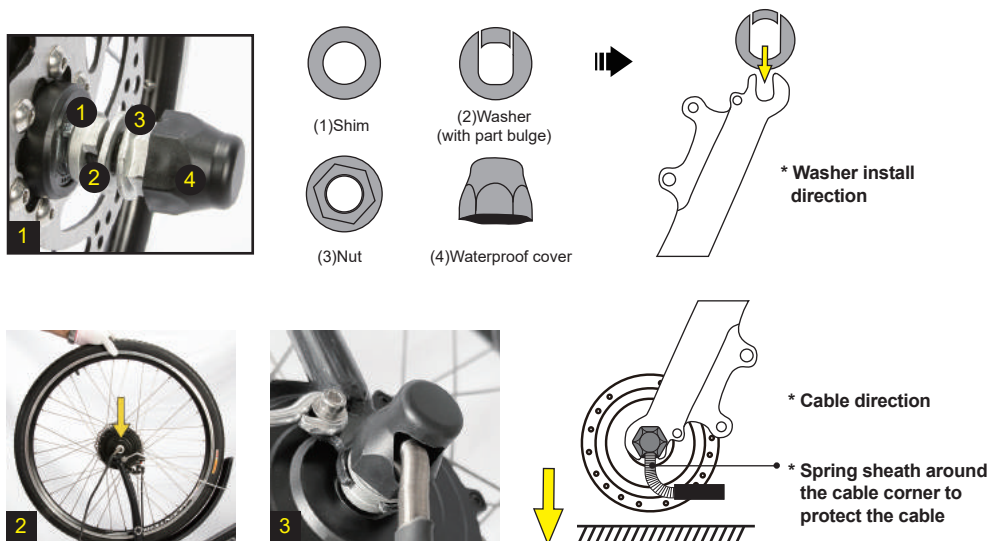

Brake Lever and Throttle installation

- Put the brake lever to the handle bar and adjust it to a comfortable position, then use the hex wrench to fix it.
- Photo 1,2: Pull out the original brake line of bike, then connect the line to the new brake lever.
- Photo 3,4: Place throttle on the right side of the bar, find a comfortable position and fasten it with hex wrench.



- Put the display on the left handle bar and fix it in a comfortable position.
- Please re-set the data of wheel diameter otherwise it will affect the speed showing (default value: 26 inch)



Install the PAS in the left pedal side

- Use puller and hex wrench to take off the left crank, then install the pass sensor (**Attention: the pass sensor spline must be matched well with crank spline**), finally install and fasten the left crank.

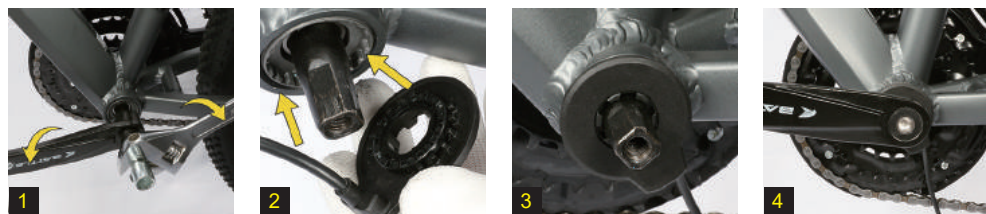



Photo 1,2: Prepare the rear rack battery, unlock and take out the battery. (convenience to assemble the rear rack)



Photo 3,4: Assemble the rear rack construction
(Please find the remark A to find the right direction)



A

M6*20mmX8



B

M6*17mmX2



C

M5*16mmX2



D

M5*12mmX2

Photo 5,6: Use screw A and tight it.
Photo 7,8: Use screw A and tight them in two edge sides.

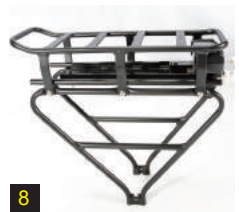
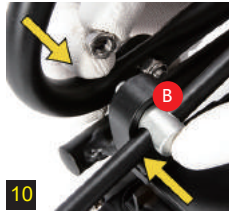
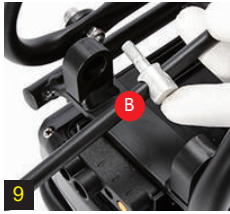

Photo 9,10: Use screw B and tight it

Photo 11,12: Use screw B and tight them in two edge sides.



Adjustable lever and rear rack assembling

Photo 1: Prepare adjustable lever(**for V brake**)

Photo 2~4: Use screw D to fix the adjustable lever in the bicycle fork, take care of the position of the screw holes and keep it vertically. Find the proper height to fix your rear rack.

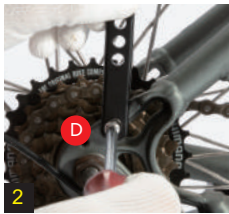

Photo 1: Prepare adjustable lever(**for disc brake**)

Photo 2~4: Use screw D to fix the adjustable lever in the bicycle fork, take care of the position of the screw holes and keep it vertically. Find the proper height to fix your rear rack.

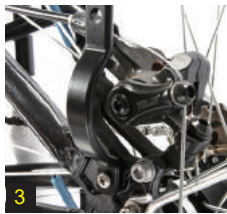
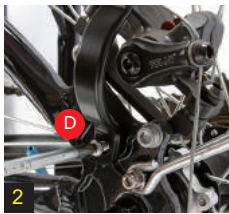

Photo 1~3: Rear rack parts assembling

Photo 4: Use screw A to fix the below part in the bicycle rear rack

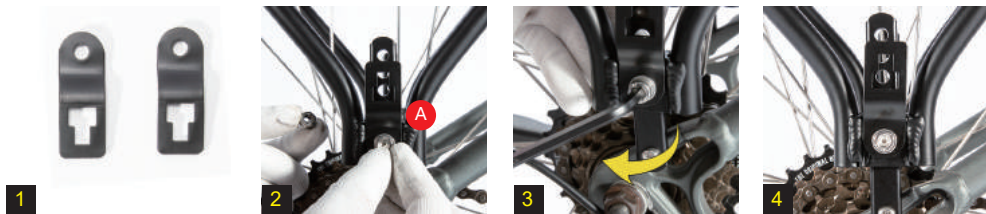
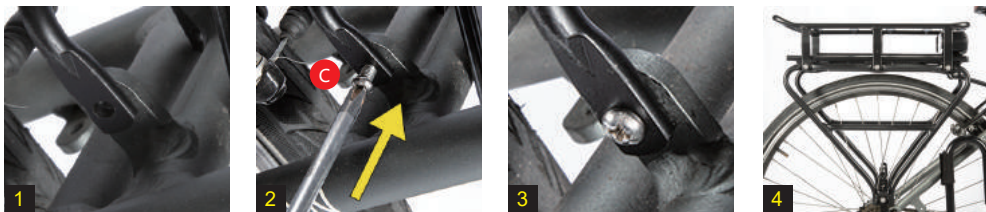

Photo 1,2: Find the assembling hole,adjust to a proper position

Photo 3,4: Screwing in screw C and fix it, check if it is strong enough.



Insert the battery

Photo 1~3: Insert the battery pack into the battery holder.



At last, install the battery and controller in the right position, and connect all connectors, then your e-bike has been done.

Deutsch

Benötigtes Werkzeug und Lieferumfang

Benötigtes Werkzeug	Lieferumfang	
Verstellbaren Schraubenschlüssel	Hub motor Rad	
Kreuzschraubendreher	Wasserdichtes Kable (5 in 1)	
Imbusschlüssel	Controller (im Batteriehalter integrieren)	LCD Display
Abzieher	PAS Sensor	Controller-Tasche/Box
	Batteriekabel	Bremshebel
	Daumengas	Frontlicht

Anschlußplan(ohne Akku)





Bild 1,2: Demontieren Sie das originale Frontrad.

Montage der Bremsscheibe/Reifen

- Bild 1: Demontieren Sie die Bremsscheibe. Dann montieren Sie sie mit Imbussschlüssel auf den Motor.
(Hinweis: Bitte verwenden Sie zur Befestigung der Bremsscheibe die Originalschrauben am Motor,sonst funktioniert der Motor möglicherweise nicht.)
- Bild 2,3: Demontieren Sie den originalen Reifen.Bringen Sie den originalen Schutzring auf die neue Felge **(dies dient zum Schutz des Fahrradreifens)**
- Bild 4: Montieren Sie den originalen Reifen auf der Radnabe.

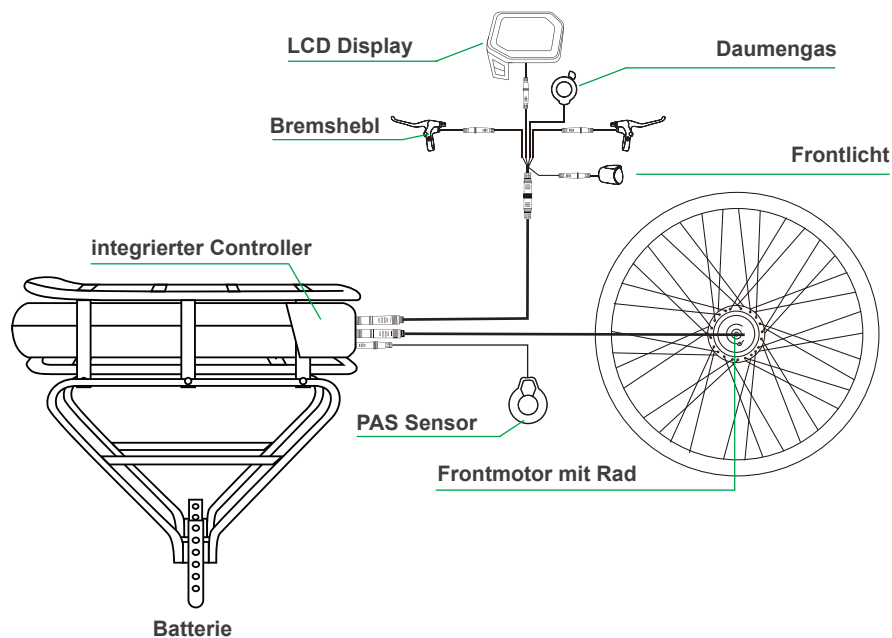
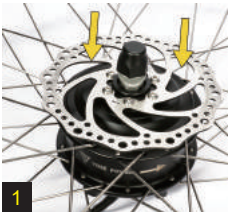

- Bild 1: Legen Sie nacheinander auf beide Seite der Motorlage die Sicherungsscheibe Unterlegscheibe und Radmutter.
- Bild 2~4: Legen Sie das Rad in die Gabelhalterung. Dann legen Sie zwischen dem Motor und Gabelhalterung die Sicherungsscheibe und befestigen die Radmutter. Hinweis: Die Richtung des Motorskabel ist nach unten.

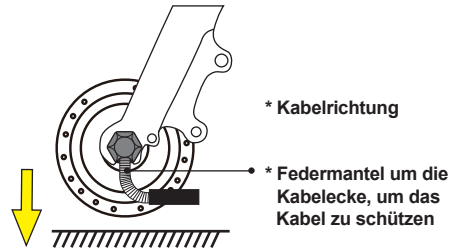
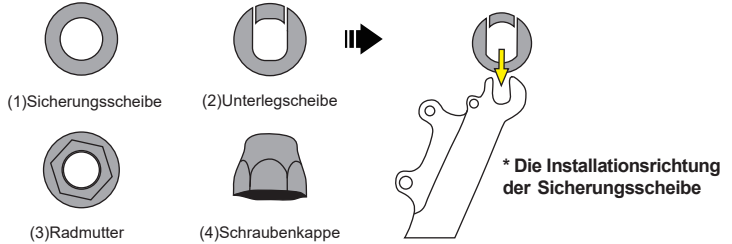
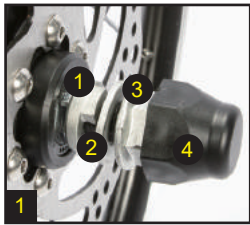

Montage der Bremshebel und Daumengas

- Geben Sie auf jede Seite des Lenkers einen Bremshebel. Finden Sie, die für Sie angenehmste Position am Lenker und fixieren Sie die Bremshebel mit Imbusschlüssel.
- Bild 1,2: Ziehen Sie das Originalbremskabel ab und verbinden Sie das Kabel dann mit dem neuen Bremshebel
- Bild 3,4: Montieren Sie den Gashebel und fixieren diesen mit Imbusschlüssel



- Montieren Sie die Halterung für das LCD Display in der linken oder rechten Lenkstange.
- Bitte stellen Sie die richtige Radgröße ein, sonst wird die falsche Geschwindigkeit zeigt.



Montage des PAS auf der linken Seite

- Entfernen Sie mit Abzieher und verstellbaren Schraubenschlüssel die linke Pedalkurbel.
- Montieren Sie den PAS Sensor.
(Achten Sie auf die Achsverzahnung und die zu befestigende Sensorverzahnung).
- Montieren und befestigen Sie die linke Pedalkurbel.





Bild 1,2: nehmen Sie den Akku vom Gepäckträger aus.



Bild 3,4: Installieren Sie die Rahmenstruktur (Hinweis: Finden Sie die richtige Installationsoberfläche durch die Oberflächenmarkierung des Rahmens A)



A

M6*20mmX8

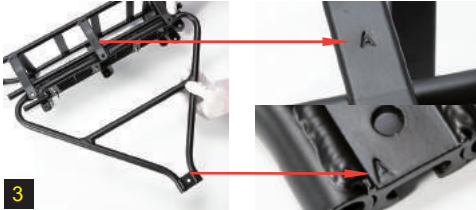

B

M5*17mmX2



C

M5*16mmX2



D

M5*12mmX2

Bild 5,6: Setzen Sie eine Schraube(A) ein und ziehen Sie sie an

Bild 7,8: Installieren Sie die Schrauben(A) nacheinander auf beiden Seiten, um sie zu befestigen.



Bild 9,10: Setzen Sie eine Schraube(B) ein und ziehen Sie sie an.

Bild 11,12: Installieren Sie die Schrauben(B) nacheinander auf beiden Seiten, um sie zu befestigen.

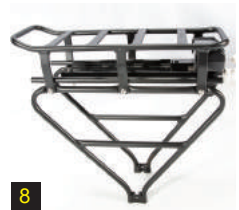
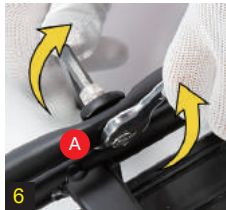
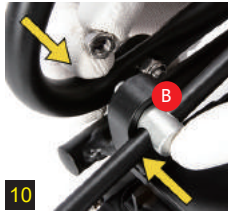
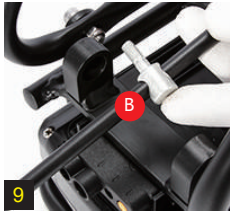

Einstellstange und die Zubehörteile montieren

Bild 1: Einstellstange

Bild 2~4: Befestigen Sie die Einstellstange mit D-Schrauben am hinteren Rahmen des Fahrrads, achten Sie auf die oberen und unteren Löcher und halten Sie sie senkrecht. Finden Sie das Loch in der richtigen Höhe, um Ihren hinteren Gepäckträger zu befestigen.



Bild 1: Bereiten Sie den Scheibenbremsen-Einstellhebel vor (**wenn Ihr Fahrrad Scheibenbremsen hat.**)

Bild 2~4: Befestigen Sie die Einstellstange mit D-Schrauben am hinteren Rahmen des Fahrrads, achten Sie auf die oberen und unteren Löcher und halten Sie sie senkrecht. Finden Sie das Loch in der richtigen Höhe, um Ihren hinteren Gepäckträger zu befestigen. Sie das Loch in der richtigen Höhe, um Ihren hinteren Gepäckträger zu befestigen.

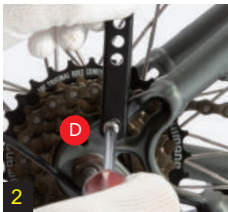

Bild 1~3: Installieren Sie die Zubehörteile

Bild 4: Befestigen Sie das Zubehör mit den A-Schrauben am hinteren Rahmen

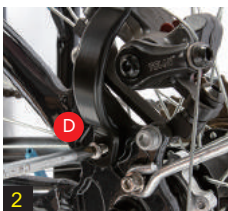

Bild 1,2: Suchen Sie die Befestigungslöcher, passen Sie die entsprechenden Positionen an

Bild 3,4: Schrauben Sie die C-Schraube ein, fixieren Sie sie dann, prüfen Sie, ob sie fest installiert ist

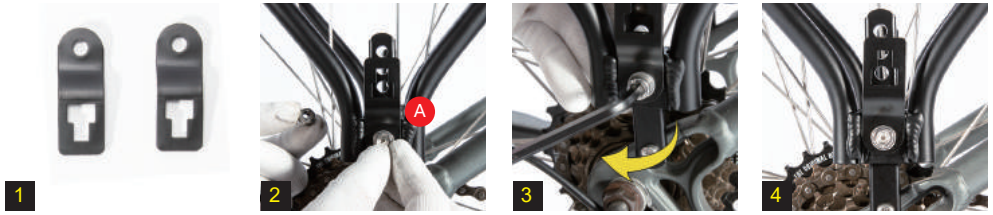
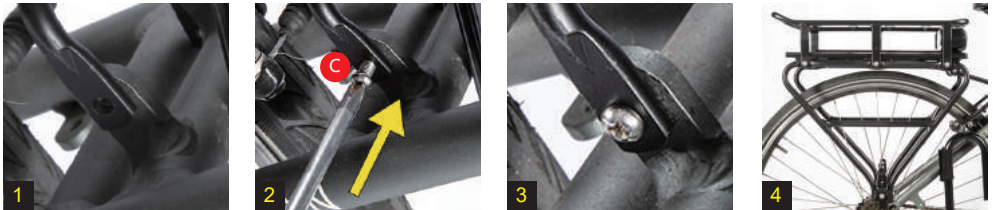

Setzen Sie den Akku in den Gepäckträger ein

Bild 1~3: Setzen Sie den Akku in den Gepäckträger ein.



Installieren Sie schließlich den Akku und den Controller in der richtigen Position und schließen Sie alle Anschlüsse an, und Ihr Elektrofahrrad ist fertig

Outils d'Installation et Liste de Produits

Outils d'Installation	Composants	
Clé à molette	Moteur de moyeu avec roue	
tournevis cruciforme	Câble étanche (5 en 1)	
clé six-pans	contrôleur (intégré dans le support de batterie)	l'écran LCD
l'extracteur	PAS Capteur	Sac/Boîte de Contrôleur
	Câble de batterie	les freins
	manette de gaz au pouce	LED feu avant

Schéma de Connexions du Kit(sans Batterie)

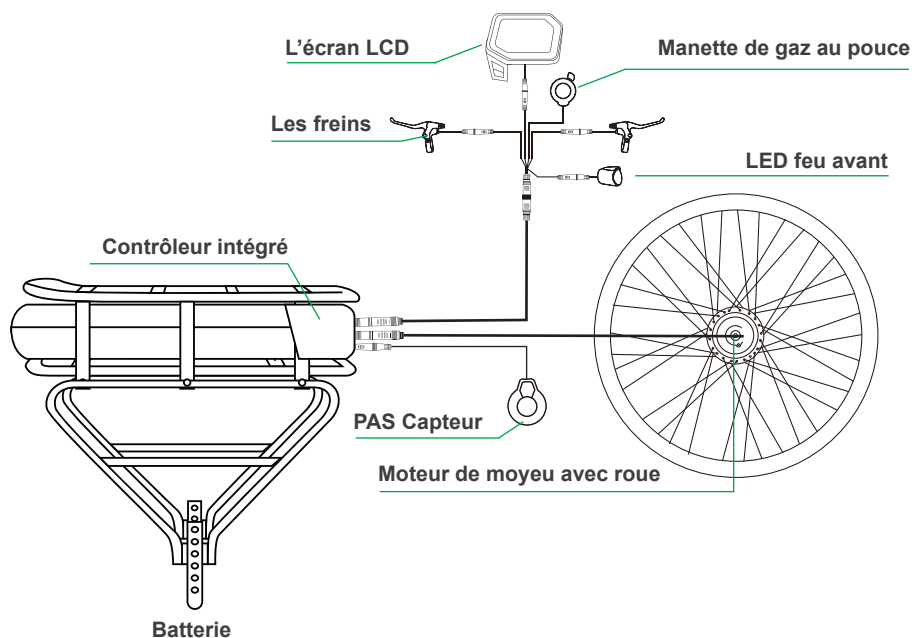



Figure 1, 2: Démontez la roue avant du vélo d'origine

Installer disque de frein/Pneu

- Figure 1: Démontez le disque de frein. Montez-le ensuite sur le moteur avec une clé six-pans. **(Remarque: veuillez utiliser les vis d'origine pour fixer le disque de frein au moteur, sinon le moteur pourrait ne pas fonctionner.)**
- Figure 2,3: Démontez le pneu d'origine et placez l'anneau de protection d'origine sur la nouvelle jante **(c'est pour protéger le pneu de vélo)**
- Figure 4: Montez le pneu d'origine sur la jante du moteur



- Figure 1: Placer la rondelle frein, la rondelle et l'écrou sur les deux côtés de l'arbre du moteur à tour de rôle.
- Figure 2 ~ 3: Placer la roue fermement dans la fourche avant. Placer ensuite la rondelle frein entre le moteur et la fourche et serrer l'écrou.
Remarque: Le sens du câble moteur est vers le bas, couvrir avec un couvercle en caoutchouc, imperméable et anti-poussière.

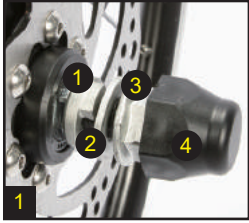

(1) rondelle frein



(2) Rondelle



(3) écrou



(4) Couvercle en caoutchouc

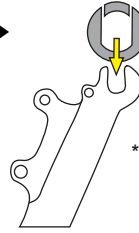

* Sens d'installation de la rondelle frein

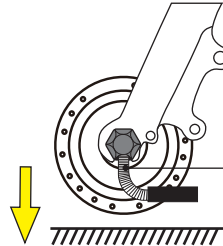

* sens du câble

* gaine à ressort autour du coin du câble pour protéger le câble

Installer les freins

- Placer un levier de frein de chaque côté du guidon. Trouvez la position la plus confortable pour vous sur le guidon et fixez les leviers de frein avec une clé six-pans.
- Figure 1~2: Débrancher le câble de frein d'origine, puis connecter le câble au nouveau levier de frein.
- Figure 3~4: Placer la manette des gaz et la fixer avec une clé six-pans.



- Placer le support de l'écran LCD sur le guidon gauche ou droit, Serrez après avoir trouvé une position confortable.
- Veuillez définir la bonne taille de roue, sinon la mauvaise vitesse sera affichée.

(Le paramètre par défaut: 26 pouces, veuillez le définir en fonction de la taille du kit acheté)



Installer le PAS à gauche

- A l'aide de l'extracteur et de la clé à molette, démontez la manivelle gauche. Alors installez le capteur PAS. (**Remarque : La cannelure du boîtier de pédalier et la cannelure du capteur doivent être alignées puis installées fermement.**) Enfin assemblez et fixez la manivelle de pédale gauche.

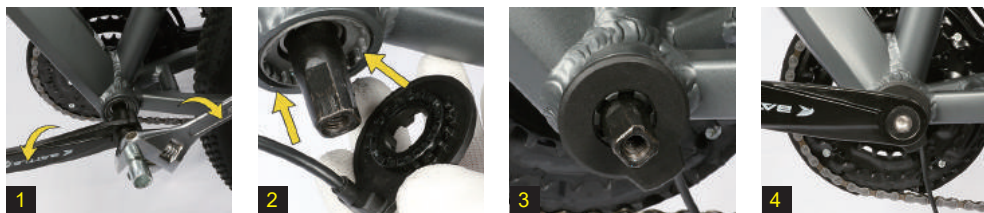



Figure 1,2 : Préparez la batterie porte-bagages , déverrouillez la batterie et retirez-la (Installation facile du porte-bagages)



Figure 3,4 : Installez la structure du porte-bagages(Remarque : trouvez la position d'installation correcte à travers la surface A marquée sur le porte-bagages)

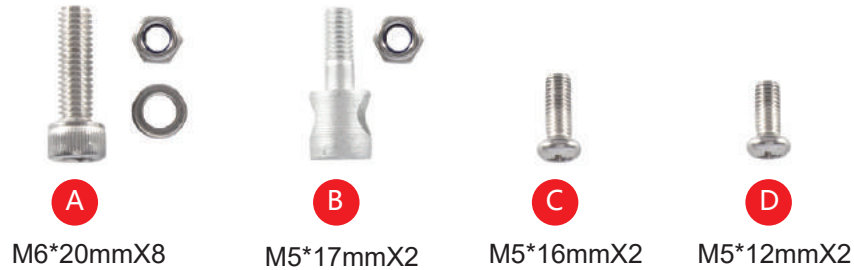

Figure 5,6 : Insérez la vis A et serrez
 Figure 7,8 : Installez les vis A des deux côtés tour à tour, et le porte-bagages est partiellement installé

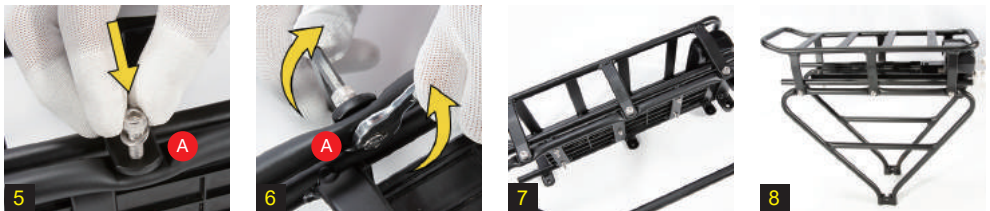
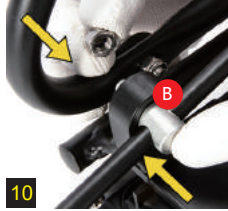
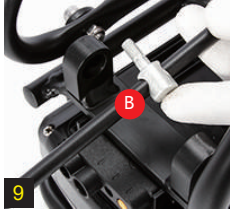

Figure 9,10 : Insérez la vis B et serrez

Figure 11,12 : Installez les vis B des deux côtés tour à tour, et le porte-bagages est partiellement installé



Levier de réglage et Installation de porte-bagages

Figure 1 : Préparez le levier de réglage

Figure 2~4 : Fixez le levier de réglage au porte-bagages du vélo avec des vis D, faites attention aux trous et maintenez-la verticale. Trouvez le trou de la bonne hauteur pour fixer votre porte-bagages

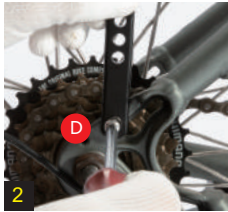

Figure 1 : Préparez le levier de frein à disque(**si vous avez des freins à disque**)

Figure 2~4 : Fixez le levier de frein à disque au porte-bagages du vélo avec des vis D, faites attention aux trous et maintenez-la verticale. Trouvez le trou de la bonne hauteur pour fixer votre porte-bagages

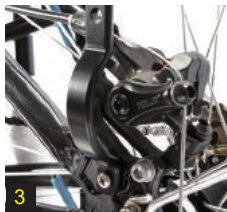
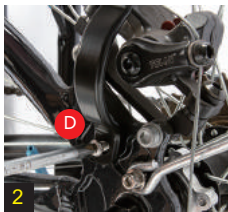

Figure 1~3 : Installez les accessoires du porte-bagages dans l'ordre
 Figure 4 : Fixez les accessoires au porte-bagages du vélo avec des vis A

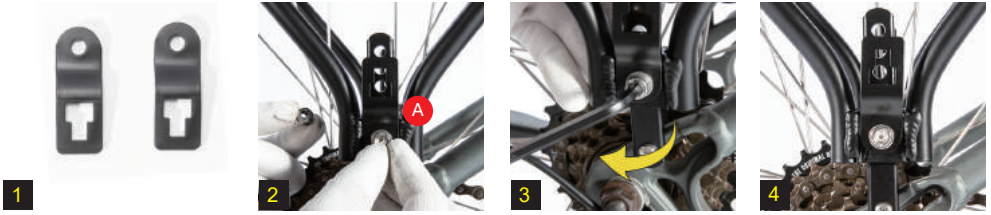
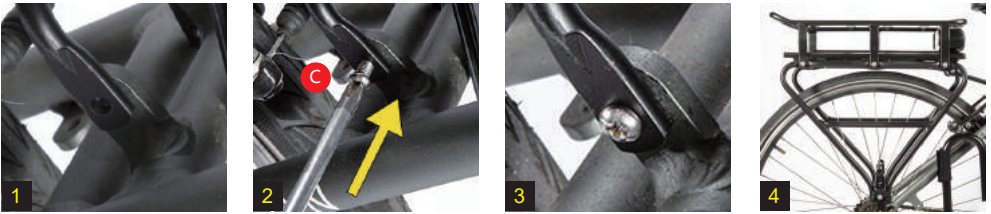

Figure 1,2 : Trouvez les trous de montage, ajustez à la bonne position et alignez les trous
 Figure 3,4 : Insérez la vis C et la fixez. Vérifiez qu'il est bien installé



Installez la batterie dans le porte-bagages

Figure 1~3 : Insérez la batterie dans le porte-bagages arrière installé



Enfin, installez la batterie et le contrôleur dans la bonne position et branchez tous les câbles, et votre vélo électrique est prêt.

Listado de herramientas y productos

Herramienta de instalación	Material	
Llave inglesa	Motor de cubo con rueda	
Destornillador cruzado	Cable de conexión impermeable (5 en 1)	
Llave hexagonal	Controlado (Integrado en el soporte de la batería)	Pantalla LCD
Herramientas para tirar	PAS Sensor	Bolsa / caja del controlador
	Cable de batería	Freno de mano
	Acelerador	Luz LED frontal

Diagrama de instrucciones de conexión del kit (Sin batería)





Foto 1,2: saca la rueda delantera de la bicicleta original

Disco de freno / instalación de neumáticos

- Foto 1: Desatornille el disco de freno original y luego instálelo en el motor con la llave hexagonal.
(Atención: utilice los tornillos del motor para sujetar el disco, de lo contrario, es posible que el motor no funcione correctamente)
- Foto 2-3: Retire el neumático original y mueva el anillo protector original a la nueva llanta **(para proteger el neumático de la bicicleta)**
- Foto 4: El neumático original está instalado en el cubo del motor.

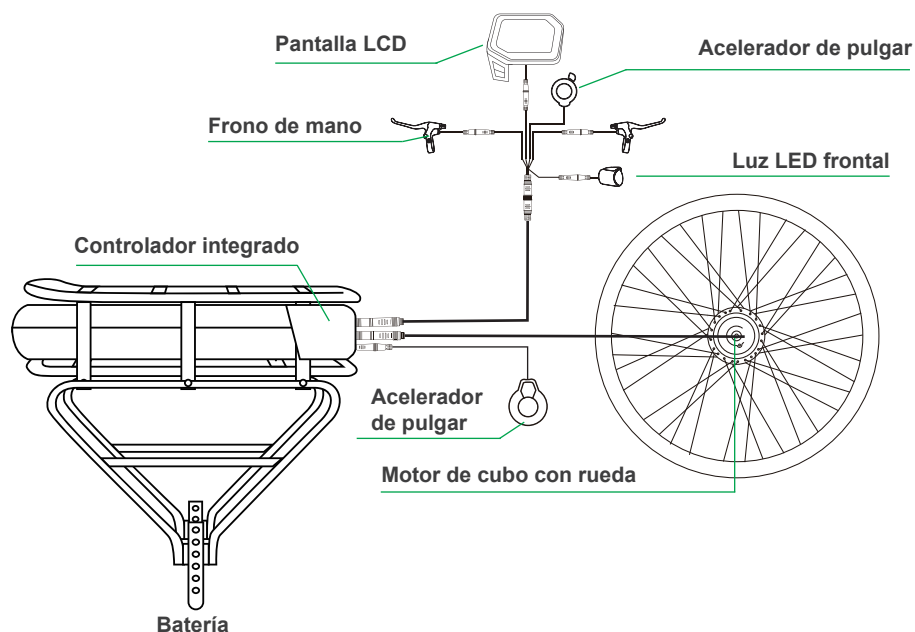

- Foto 1: coloque arandela (**parcialmente saliente**), arandela y tuerca en secuencia en ambos lados del eje del motor.
- Foto 2-4: Coloque la rueda trasera en la horquilla trasera, coloque arandela (**parcialmente saliente**) entre el motor y la horquilla, luego use la llave para apretar la tuerca.
Nota: Tenga en cuenta que el cable del motor debe mirar hacia abajo, cubrir la tapa impermeable.

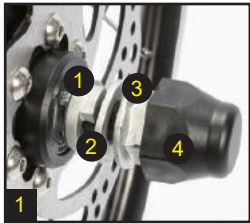

(1) Arandela



(2) Arandela (parcialmente saliente)



(3) Tuerca



(4) la tapa impermeable.

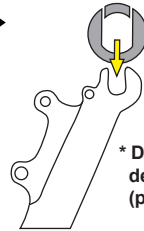

* Dirección de instalación de la arandela (parcialmente saliente)



2



3

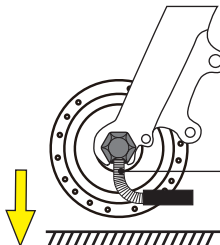

* Dirección del cable

* La funda de resorte protege la línea alrededor de la esquina de la salida.

Instale la palanca de freno y el acelerador

- Coloque la barra de freno en el manillar y ajústela a una posición cómoda, luego use la llave hexagonal para fijarla.
- Foto 1-2: Extraiga la línea de freno original de la bicicleta, luego conecte la línea a la nueva palanca de freno.
- Foto 3-4: Coloque el acelerador en el lado derecho de la barra, encuentre una posición cómoda y fíjela con hex llave inglesa.

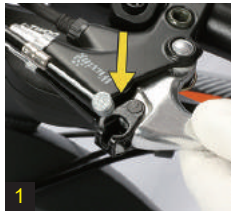

1



2



3



4

- Coloque la pantalla LCD en el asa izquierda y apriétela después de encontrar una posición cómoda.
- Vuelva a configurar los datos del diámetro de la rueda; de lo contrario, afectará la velocidad que se muestra (**valor predeterminado: 26 pulgada**)



Instale PAS en el lado izquierdo del pedal

- Use Herramientas para tirar y una llave hexagonal para quitar la manivela izquierda, luego instale el sensor PAS (**Atención: la ranura del sensor PAS debe coincidir bien con la ranura de la manivela**), finalmente instale y apriete la manivela izquierda.





Foto 1,2: Prepare la batería del portaequipajes trasero, desbloquee la batería y sáquela. (Para la comodidad de la instalación del bastidor trasero)



Foto 3,4: instalación del bastidor trasero (Nota: encuentre la superficie de instalación correcta marcando el lado A del marco)



Bild 5,6: Inserte el tornillo A y apriete.

Bild 7,8: Instale los tornillos A en ambos lados para fijar.

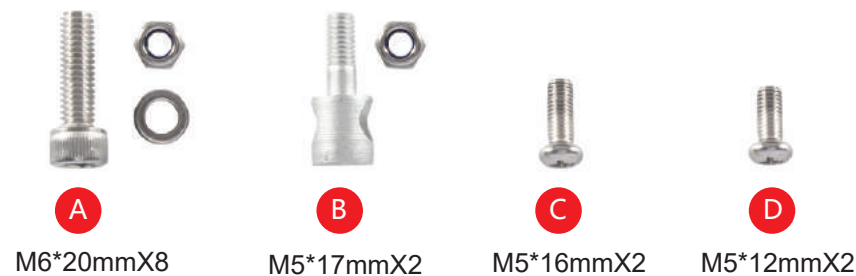

Foto 9,10: Inserte el tornillo B y apriete.

Foto 10,11: Instale los tornillos B en ambos lados para fijar.

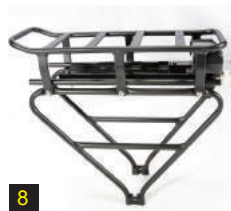
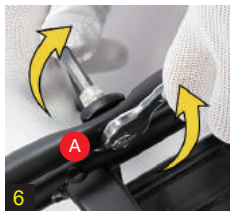
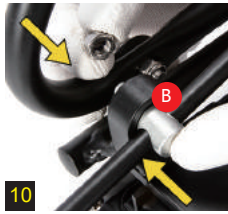
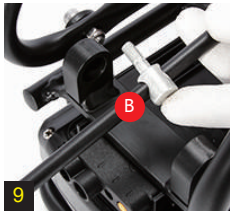

Barra de ajuste y soporte trasero para portaequipajes

Foto 1: Prepara la palanca

Foto 2~4: Fije la varilla de ajuste al cuadro trasero de la bicicleta con tornillos D, preste atención a los orificios superior e inferior y manténgala vertical. Encuentra un agujero que se ajuste a la altura para arreglarlo.



Foto 1: Prepare la palanca de ajuste del freno de disco (si su modelo tiene frenos de disco)

Foto 2~4: Fije la varilla de ajuste al cuadro trasero de la bicicleta con tornillos D, preste atención a los orificios superior e inferior y manténgala vertical. Encuentra un agujero que se ajuste a la altura para arreglarlo.

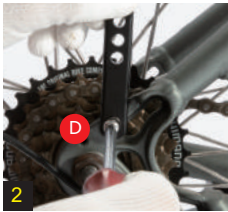

Foto 1~3: Instale los accesorios en secuencia.

Foto 4: Fije los accesorios al bastidor trasero con tornillos A

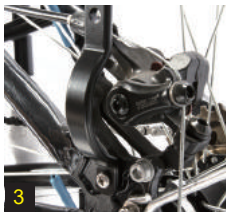
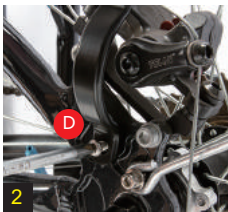

Foto 1,2: busque los orificios de montaje, ajuste las posiciones adecuadas y alinee los orificios.

Foto 3,4: Inserte el tornillo C, luego fijelo, verifique si está firmemente instalado.

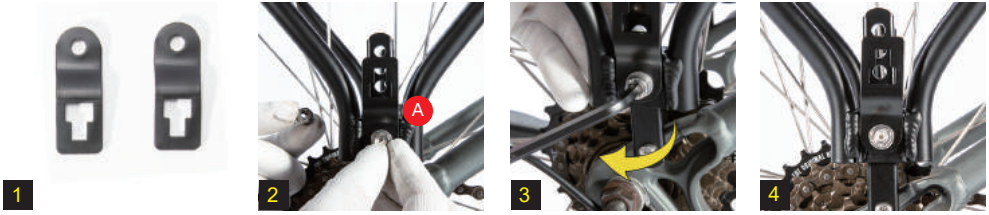
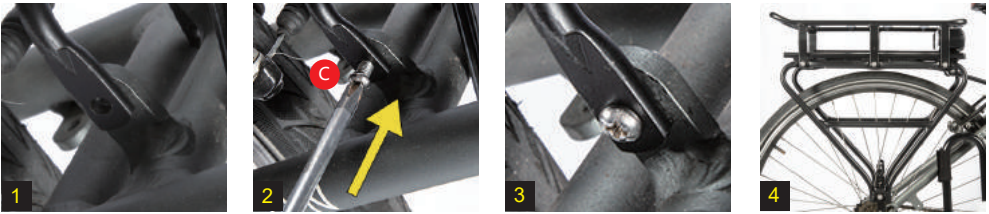

Instale la batería

Foto 1~3: Inserte la batería en el portaequipajes trasero instalado.



Finalmente, instale la batería y el controlador en la posición correcta, y conecte todos los conectores, su bicicleta eléctrica está completa.



<https://bit.ly/2z4sPn2>





Watch the installation video on youtube yosepower official channel



Europe
Official website
www.yosepower.com



USA
Official website
www.yosepowershop.com

Marking			
<table border="1"> <tr> <td>EC</td> <td>REP</td> </tr> </table>	EC	REP	<p>EUBRIDGE ADVISORY GMBH Virginia Str. 2 35510 Butzbach,Germany eubridge@outlook.com Tel: 004915731153070</p>
EC	REP		
<table border="1"> <tr> <td>UK</td> <td>REP</td> </tr> </table>	UK	REP	<p>TANMET INT'L BUSINESS LTD 9 Pantygraigwen Road, Pontypridd, Mid Glamorgan, CF37 2RR,UK tanmetbiz@outlook.com Tel: 00442922550866</p>
UK	REP		
    	<p>Batt-Reg.-Nr.DE 10983121 VerpackG:DE 5677895103216 WEEE-Reg-Nr:DE 31838004</p>		



YOSE POWER CO.,LTD.

Add: Changxing County, Zhejiang Porvince, China.
E-mail:service@yosepower.com