



The eBike Display
User Manual

KD21C

Contents

Product name and model.....	1
Specifications.....	1
Appearance and dimension.....	1
Function and button definition.....	2
◆Function summary.....	2
◆Functional area distribution.....	2
◆Button definition.....	2
Installation.....	3
General operations.....	3
◆Switch E-bike system ON/OFF.....	3
◆Display interface.....	3
◆Switch push-assistance mode ON/OFF.....	4
◆Switch lighting ON/OFF.....	4
◆Assist level selection.....	5
◆Battery indicator.....	5
◆Error code indication.....	6
General Settings.....	6
◆Trip distance clearance.....	6
◆Backlight brightness.....	7
◆Toggle the unit KM/miles.....	7
General parameters information.....	8
◆Wheel diameter information.....	8
◆Speed limit information.....	8
Personalized parameters settings.....	9
◆Battery power bar settings.....	10
◆Assist level settings.....	10
Assist level mode options settings.....	10
◆Power-on password settings.....	11
Power-on password Enable/Disable.....	11
Power-on password change.....	11
◆Exit settings.....	12
Recover default settings.....	12
Quality assurance and warranty scope.....	13
Wire connection layout.....	13

Warnings.....	14
Attached list 1: Error code definitions.....	14
Attached list 2: Personalized settings symbols.....	15
Attached list 3: Other symbols.....	15

Product name and model

E-bike Intelligent LCD Display
Model: KD21C.

Specifications

- 24V/36V/48V Power Supply
- Rated working current: 10mA
- The maximum working current: 30mA
- Off-state leakage current: $<1\mu\text{A}$
- Working temperature: $-20^{\circ}\text{C} \sim 60^{\circ}\text{C}$
- Storage temperature: $-30^{\circ}\text{C} \sim 70^{\circ}\text{C}$

Appearance and Dimension

Product appearance and dimensional drawing (unit: mm)

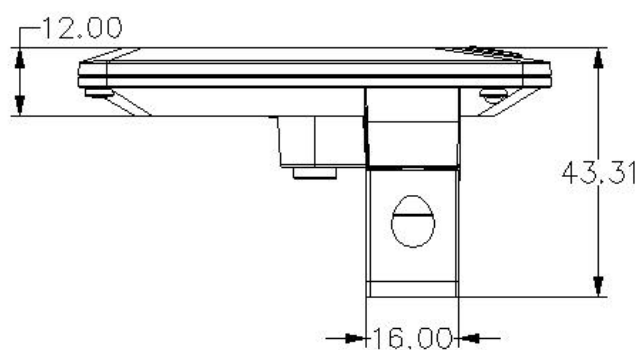
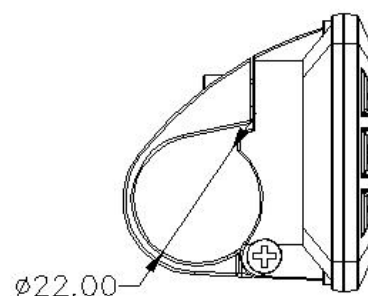
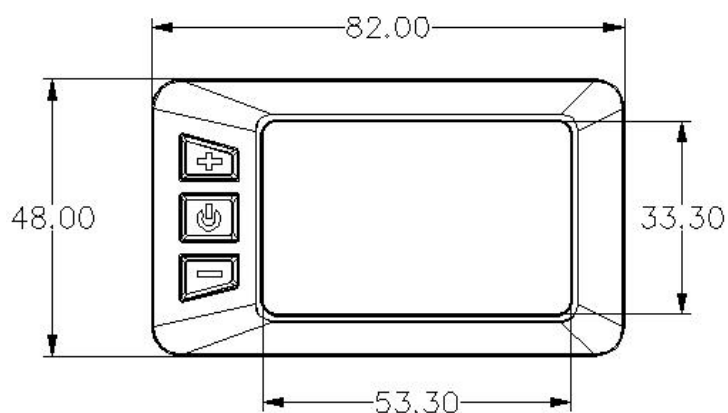

Function Summary and Button Definition

◆Function Summary

KD21C has many functions to meet riders' needs. The indication elements are as follows:

- Battery level
- Motor output power
- Assist level
- Speed indication (incl. current speed, Max. speed and Avg. speed)
- ODO and Trip
- Push-assistance function
- Trip time
- Backlight ON/OFF
- Error code indication
- Various Parameters Information and Settings (e.g. wheel diameter, speed limit, battery power bar, assist level, current limit, maximum speed, password enable, etc.)
- Recover Default Settings

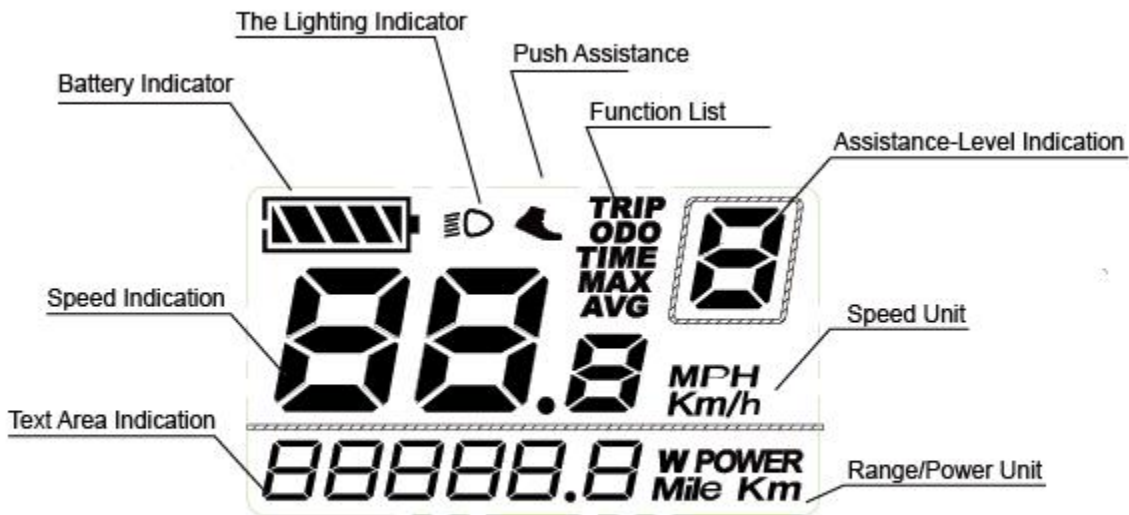

◆Functional Area Distribution



Functional Area Distribution

◆Button Definition

There are three buttons ( ,  , ) on KD21C display. In this manual, we use words **ON/OFF**,

UP, **DOWN** to represent these 3 symbols ( ,  , ).

Installation

KD21C can be mounted on the left side of handlebar close to its grip. Adjust the angle for a good screen view. Cut off the power before connecting the corresponding connectors between display and controller.

General Operation

◆ Switching the E-bike System mode ON/OFF

To switch on the E-bike system and provide the power supply to the controller, hold the On/Off button for 2s.

To switch off E-bike system, hold the **ON/OFF** button for 2s. The E-bike system no longer uses the battery power.

When E-bike system is switched off, the leakage current is less than 1 μ A.

If “**On/Off**” button or “-” button is sticky, an error code will be shown on the screen. Please refer to **Attached List 1** as for “sticky button” error code definition details.

If an improper operation by user occurs (eg. an excess pressing on “**On/Off**” button or pressing “**On/Off**” button and “-” button simultaneously), the user can switch off the display and restart.

■ **When the E-bike is parked for approx. 10 minutes, the E-bike system switches off automatically.**

◆ Display Interface

After switching on the E-bike system, the display shows Current Speed and ODO(total distance) by default.

Press the **ON/OFF** button to switch between indication functions below:

ODO (Km)→ Trip (Km) → Trip Time (Hour) → Motor Power (W)→ODO (Km)→ Max. Speed (Km/h)→ Avg. Speed (Km/h) , it cycles back to ODO km again.

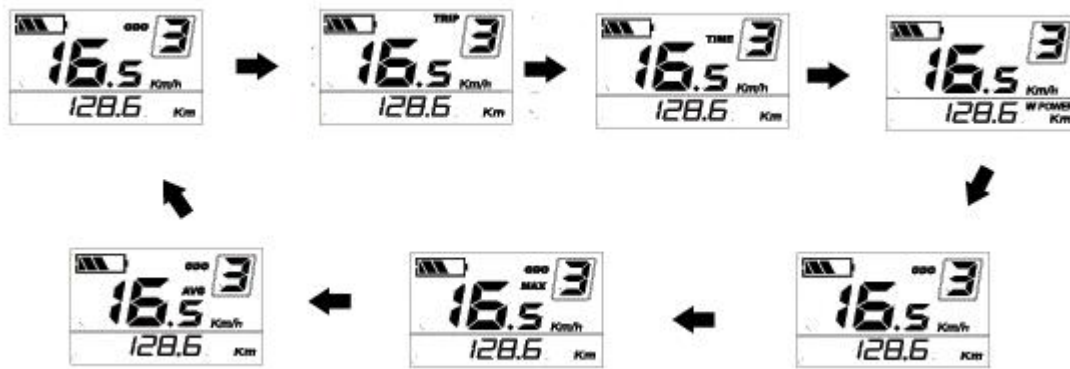

Display indication cycle interface

◆Switching Push-assistance mode ON/OFF

To activate the push-assistance function, press and hold the **DOWN** button. After 2 seconds, E-bike is activated to go at a uniform speed of 6 Km/h while the screen displays “ P”.

The push-assistance function will be switched off as soon as you release the **DOWN** button.

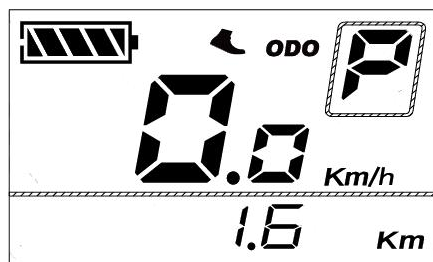

Push-assistance mode

■Push-assistance function may only be used when pushing the E-bike. Be aware of danger of injury when bike wheels do not have ground contact while using the push-assistance function.

◆Switching Lighting ON/OFF

To switch on E-bike front light or rear light, press the “**UP**” button for 2s. The display backlight brightness is automatically reduced while the screen displays “ D”.

Likewise, press the “**UP**” button for 2s again, the bike front light and rear light can be switched off and display backlight recover its brightness.

*If E-bike front light or rear light is independent of “**UP**” button, the “**UP**” button can only be used to switch on/off the display backlight.

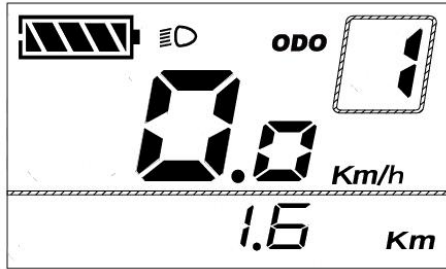

Switching Lighting on/off

◆ Assist Level Selection

The assist level of the E-bike drive can be changed anytime, even during riding.

The assist level ranges from 0 to 5 (level 0 to level 5). The default assist level is “1” when the display is started. The output power is zero on Level “0”. Level “1” is the minimum output power. Level “5” is the maximum output power.

Press **UP/DOWN** button to switch between the E-bike system assist levels and change the motor output power.

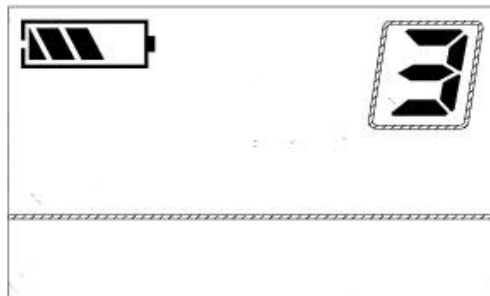

Assist Level “3”

◆ Battery Indicator

The five battery power bars represent the capacity of the battery. The five battery bars are bright when the battery is in full voltage. When the battery is in low voltage, battery frame will flash at the frequency of 1HZ to give a notice that the battery needs to be recharged immediately



Battery Indicator

◆ Error Code Indication

The components of the E-bike system are continuously and automatically monitored. When an error is detected, the respective error code is indicated in text indication area. Refer to detailed definition of the error codes in **Attached list 1**.

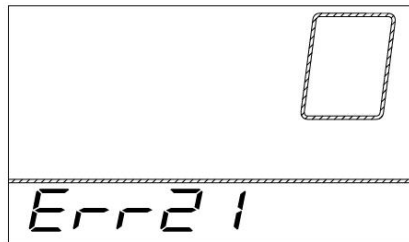

Error Code Indication

■ **Have the display inspected and repaired when an error code appears. Or else, you will not be able to ride the bike normally. Please always refer to an authorized bicycle dealer.**

General Settings

After the E-bike system is switched on, hold both the **UP** button and **DOWN** button simultaneously for 2s to access general settings menu.

■ **All the Settings are completed on a parked E-bike.**

◆ Trip Distance Clearance

TC represents trip distance clearance settings.

Press the **UP/DOWN** button to choose Y or N. The default value is N.

To store a changed setting, press the **ON/OFF** button and access backlight settings.

For symbols and their definitions, please refer to **Attached list 3**.

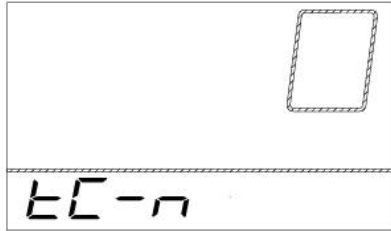

Trip Distance Clearance Settings Interface

◆ Backlight settings

bL represents backlight settings. Level “1” is the lowest brightness. Level “2” is the medium brightness. Level “3” is the highest brightness. The default value is “1”.

To change the backlight brightness, press the **UP/DOWN** button to increase or decrease until the desired brightness is displayed.

To store a changed setting, press the **ON/OFF** button and access unit toggling settings.

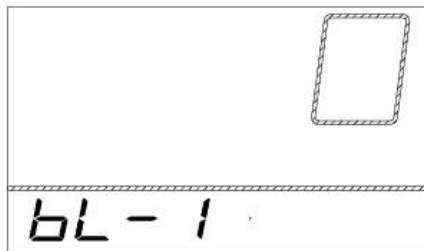

Backlight Brightness Setting Interface

◆ Unit km/mi toggling

U represents unit settings, “1” is mile, and “2” is kilometer. The default value is “2”.

To toggle the unit, press the **UP/DOWN** button until the desired unit is displayed.

To store a changed setting, press the **ON/OFF** button and access trip distance clearance settings again or hold the **ON/OFF** button for 2s to exit **General Settings**.

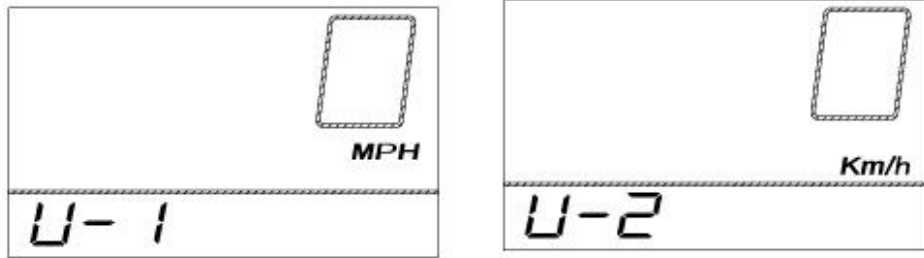

Mile and Kilometer toggling Settings Interface

General Parameter Information

To access general parameter information interface, hold both the **UP** and the **DOWN** button simultaneously for 2s to enter **General Settings**, then hold both the **DOWN** and **ON/OFF** button for 2s to enter **General Parameter Information**.

◆Wheel Diameter Information

Ld represents wheel diameter information. Press **ON/OFF** button and access speed-limit information interface.

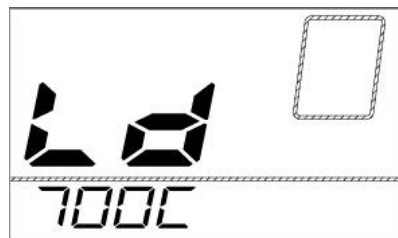

Wheel Diameter Information Interface

◆Speed limit Information

LS represents the speed limit information. Hold the **ON/OFF** button for 2s to exit **General Parameter Information**.

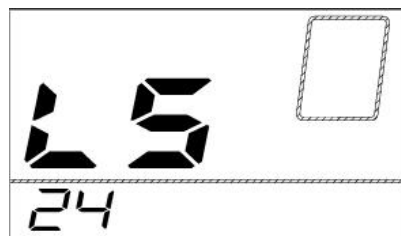

Speed Limit Information Interface

Personalized Parameter Settings

Personalized Parameter Settings can meet a variety of riders' personalized requirements. 3 options are Battery Power Bar Settings, Power assist level Settings and Power-on Password Settings. Please refer to **Attached list 2** for the definition of the symbols.

Hold **UP** and **DOWN** button simultaneously for 2 seconds to enter **General Settings** and Hold **UP** and **DOWN** button simultaneously for another 2 seconds to enter **Personalized Parameter Settings** interface.

Press **UP** or **DOWN** button to choose the personalized parameter for settings, then press **ON/OFF** button to enter the corresponding settings interface.



Setting Item Cycle Interface

◆ Battery Power Bar Settings

VOL represents voltage settings. Each bar represents a voltage value. Each of the 5 values is to be entered one by one. For example, VOL 1 is the first bar voltage value, the default value is 31.5V. Press **UP** or **DOWN** button to increase or decrease the bar value and press **ON/OFF** button to store a changed setting and access the second bar. Likewise, you can set the values in the same manner for other bars. After values for 5 bars are entered completely, press **ON/OFF** to confirm and return to the previous menu.

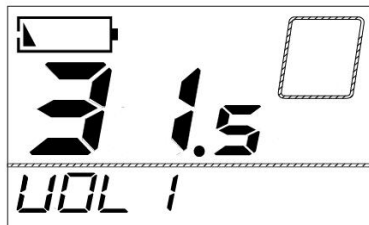

Battery Bar Settings

◆ Assist Level Settings

SCA represents assist level settings.

Assist Level mode options

There are 8 assist level modes: 0-3, 1-3, 0-5, 1-5, 0-7, 1-7, 0-9, 1-9. The default mode is 0-5.

Press the **UP/DOWN** button to increase or decrease until the desired mode is displayed.

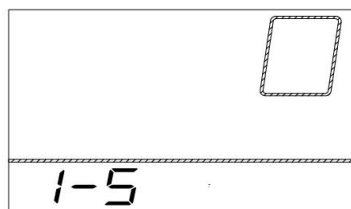

"1-5" flash

Assist Level Setting Interface

◆ Power-on Password Settings

PSd represents power-on password settings. Power-on password is a 4-digit code. The default password is “1212”.

Press **ON/OFF** button to enter the interface where “P2, 0000” is shown on the screen. Please input the current password or default password ‘1212’.

Press **UP/DOWN** button to increase or decrease the number and press **ON/OFF** button to confirm digits one by one until the correct 4-digit password is completed. Press **ON/OFF** button to access power-on password Enable/Disable Settings.

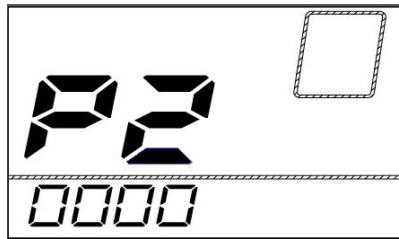

Password Input Interface

Power-on Password Enable/Disable

Press **UP** or **DOWN** button to choose Y or N and press **ON/OFF** button to confirm. Y means power-on password is enabled. N means power-on password is disabled. The default value is N.

If you choose Y, press the “**ON/OFF**” button and then access power-on password change interface.

If you choose N, you will exit the power-on password settings interface and return to previous menu.

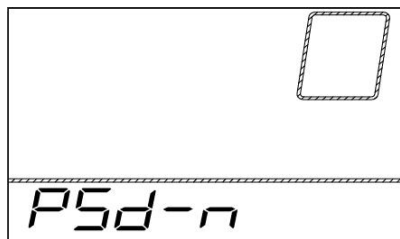

Power-on Password Disable Interface

Power-on Password Change

When the display shows P3, 0000, press **UP/DOWN** to change the number and then press **ON/OFF** button to confirm digits one by one until a new 4-digit password is completed.

To store the new power-on password, hold **ON/OFF** button for 2 s and then exit settings.

When you switch on the E-bike system next time, the display will show P1,0000, please input the new password to power on.

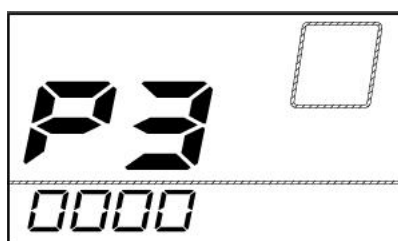

Power-on Password Change Interface

◆Exit settings

In Personalized Parameter Settings Interface,

Press the **ON/OFF** button is to confirm the input.

Hold the **ON/OFF** button is to store the settings and exit the current setting.

Hold the **DOWN** button is to cancel the operations but not to store setting data and return to previous menu.

■If there is no operations in two minutes, the display will exit the settings interface.

Recover default settings

dEF represents recovering default settings. The default value is N.

To access recover default settings, hold both **UP** and **ON/OFF** button for 2s and then access selection interface. Press the **UP/DOWN** button to choose “Y” or “N”. “N” means not recovering default settings. Y means recovering default settings.

When it is “Y”, hold the **ON/OFF** button for 2s to recover default settings, the display shows DEF-00 at the same time and returns to display start-up page .

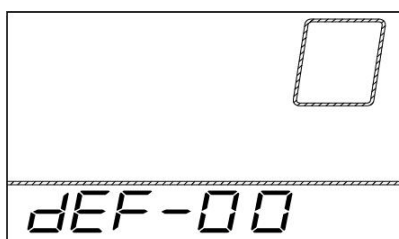

Recover Default Settings Interface

Quality assurance and warranty scope

I Warranty

- 1) The warranty will be valid only for products used in normal usage and conditions.
- 2) The warranty is valid for 24 months after the shipment or delivery to the customer.

II Others

The following cases do not belong to warranty scope:

- 1) The display is demolished.
- 2) The damage of the display is caused by wrong installation or operation.
- 3) The shell of the display is broken after the display is out of the factory.
- 4) The cable of the display is broken.
- 5) Beyond warranty period.
- 6) The fault or damage of the display is caused by the force majeure (e.g., fire, earthquake, etc.)

Connection layout

Connector wire sequence

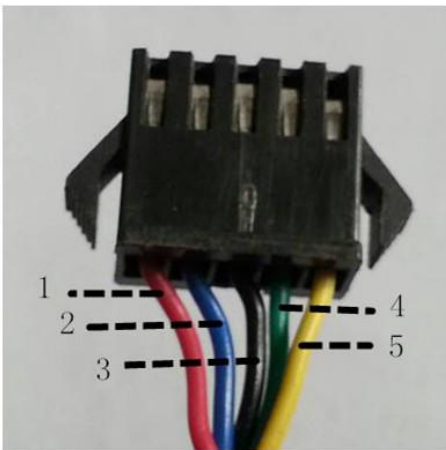

Connector to controller

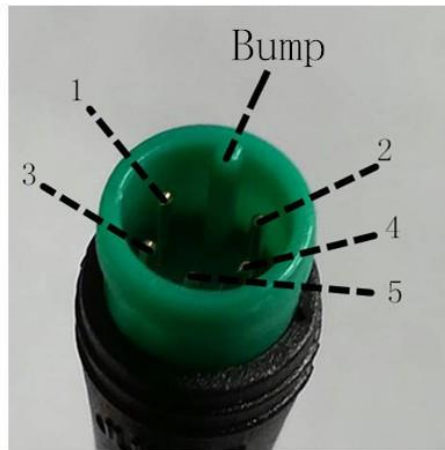

display end

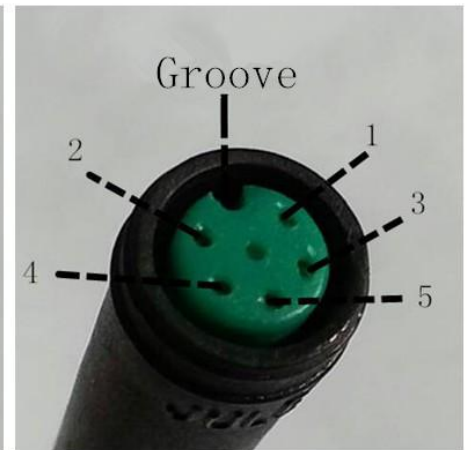

connection wire end to display end

Wire sequence table

Wire sequence	Color	Function
1	Red(VCC)	+
2	Blue(K)	Lock
3	Black(GND)	-
4	Green(RX)	RX
5	Yellow(TX)	TX

■Some displays have wire connection with water-proof connectors, users can not see the color of lead wires in the harness.

Warnings:

1. Use the display with caution. Don't attempt to release or link the connector when battery is power on.
2. Try to avoid hitting the display.
3. Don't modify system parameters to avoid parameter disorder.
4. Make the display repaired when error code appears.

■This manual instruction is a universal version for **DISPLAY KD21C**. Some versions of this display may be different from specification to specification as to the software. Please always refer to an actual version.

Attached list 1: Error code definition

Error Code	Definition
21	Current Abnormality
22	Throttle Abnormality
23	Motor Phase Abnormality
24	Motor Hall Signal Abnormality
25	Brake Abnormality
30	Communication Abnormality
31	MOSFET tube short-circuit
32	“On/Off” button sticky
33	“-” button sticky
34	Over voltage failure

Attached list 2: Personalized Parameter settings

No.	Settings item	Symbol
1	Battery Power Bar Settings	<i>UOL</i>
2	Power assistant level Settings	<i>SC_R</i>
3	Power-on Password Settings	<i>PS_d</i>

Attached list 3: Other symbols

No.	Symbol	Definition
1	<i>EC</i>	Trip distance clearance
2	<i>BL</i>	Backlight
3	<i>U</i>	Unit
4	<i>UOL</i>	Voltage
5	<i>LD</i>	Wheel diameter
6	<i>LS</i>	Speed limit
7	<i>PS_d</i>	Password
8	<i>DEF</i>	Recover default
9	<i>Y</i>	Yes
10	<i>N</i>	No