

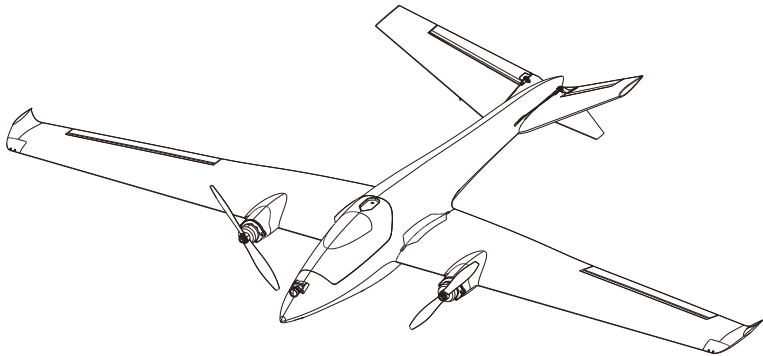

User Manual

Swordfish

剑鱼



Introduction/简介

The swordfish is a 1200mm wing span middle speed twin motor glider, the large V-tail improves the cruising speed stability, the aerodynamic shape and low cross-sectional area reduce flight resistance and improve endurance.

We use lots of plastic injection parts to reduce the wight, size and also improved the strength.

The fuselage and the wing are embedded with reinforced carbon tubes to maximize the torsional rigidity of the wing during flight and the structural strength of the tail connection. Improved the control of precise flight. The belly wheel and the tail skid design protect the bottom of the fuselage from landing.

The glider support DJI air unit, also support analog system, the 1000g±200g take off weight made the plane achieves balanced load on the take-off wing, balanced cruise speed, and convenient assembly and maintenance.

剑鱼 (Swordfish) 是一款1200mm翼展V尾布局的中速FPV双发滑翔机，超大的V尾翼提高巡航时的稳定性。在满足搭载FPV飞行的必要设备且便于安装维修的情况下，尽可能的减少机身的横截面积，提高飞机流线性、减少飞行阻力、提高续航能力。

这款飞机我们使用大量的注塑结构配件，优化了泡沫飞机在使用过程中的问题。从机翼快拆结构件、电调电机安装座、V尾快装结构、图传天线安装座、到航灯等注塑配件，在尽可能的减少飞机体积的情况下，提供更易操作、更便捷装配的稳定结构。

机身和机翼均预埋加强碳管，增加飞行过程中机翼的抗扭钢性和机尾连接的结构强度、提高精准飞行的操控。机腹机轮和尾部的滑撬设计，对机身底部起到一定程度的保护，可以在硬地面滑降。

在最常见的用户搭载【飞控+DJI天空端（模拟图传）+摄像头+GPS】1000g±200g起飞重量的FPV飞行任务中，该款飞机的设计做到了起飞翼载荷均衡、巡航航速均衡、装配维修便捷。

Specifications/规格

Swordfish Specifications/剑鱼规格	
Wingspan/翼展:	1200mm
Length/长度:	810mm
WingArea/翼面积:	15.35dm ²
Servo/舵机:	9g Servo*4PCS
Material/材料:	EPP
Recommend Motor/推荐电机:	2004~2306
Recommend ESC/推荐电调:	BLS 30A 2~4S
Recommend Propeller/推荐螺旋桨:	7040-2
Recommend Weight/建议起飞重量	1200g

Version Description/版本说明

ATOMRC Swordfish Fixed Wing						
	Version	KIT	PNP	FPV	RTH	RTF+FPV
	Description	Pre-glued Fixed WING	KIT+Motor +ESC+Servo	PNP+VTX+Camera	PNP+Pre-turned FC+GPS, all electronics are installed	RTH+VTX+Camera, all electronic are installed
Basic Pack	Pre-Build KIT	√	√	√	√	√
	Wood plate	√	√	√	√	√
	Screws and Nuts	√	√	√	√	√
	Sticker and user manual	√	√	√	√	√
	Quick Release Connector	√	√	√	√	√
	Flight Light	√	√	√	√	√
Motor	ATOMRC 2306 2000kv		2pcs	2pcs	2pcs	2pcs
ESC	ATOMRC BLS 30A 2-4S		2pcs	2pcs	2pcs	2pcs
Servo	ATOMRC 9g *300mm		4pcs	4pcs	4pcs	4pcs
Prop	7040-2		4pcs	4pcs	4pcs	4pcs
Cam	Foxeer Toothless NANO			√		√
VTX	ATOMRC Exceed TX500 VTX			√		√
Antenna	ATOMRC			√		√
FC	ATOMRC F405 NAVI				√	√
GPS	BN220				√	√
The specs will be slightly adjusted according to different, actual specs are subject to the latest manual and real objects.						

ATOMRC 剑鱼固定翼						
	版本	KIT	PNP	FPV	RTH	RTF+FPV
	版本描述	泡沫预装好	泡沫预装好, 电子配件不组装	泡沫预装好, 电子配件不组装	泡沫、电子配件、飞控组装调试完成	泡沫、电子配件、飞控组装调试完成
基础配件	预组装的泡沫配件	√	√	√	√	√
	木片	√	√	√	√	√
	螺丝和螺母	√	√	√	√	√
	贴纸和用户手册	√	√	√	√	√
	快拆套件	√	√	√	√	√
	航灯	√	√	√	√	√
电机	ATOMRC 2306 2000kv		2pcs	2pcs	2pcs	2pcs
电调	ATOMRC BLS 30a ESC		2pcs	2pcs	2pcs	2pcs
舵机	ATOMRC 9g *300mm		4pcs	4pcs	4pcs	4pcs
螺旋桨	7040-2		4pcs	4pcs	4pcs	4pcs
摄像头	Foxeer Toothless NANO			√		√
图传	ATOMRC Exceed TX500 VTX			√		√
天线	ATOMRC 5.8G 螺旋天线			√		√
飞控	ATOMRC F405 NAVI				√	√
GPS	BN220				√	√
实际配置参数根据不同的出货批次, 会有细微调整。最新配置参数请留意Atomrc的官网, 最终参数以实物为准。						

KIT Contents

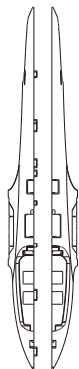

FA-L/FA-R:
Fuselage/机身

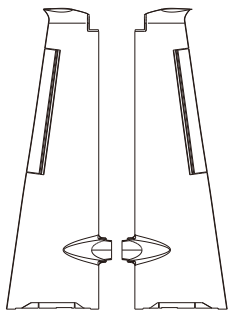

FD-L/FD-R:
Wing/左右机翼



FF:
VTX Hatch/图传舱盖



FG:
GPS Hatch/GPS舱盖

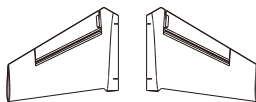

FH-L/FH-R:
V Tail/V尾



FB:
Cam Hatch/摄像头舱盖



FE:
Bottom Hatch/设备舱盖



FC-1:
Front Hatch1/平台舱盖



FC-2:
Front Hatch2/电池舱盖



PE-L/PE-R/PF-L/PF-R:
Wing quick release/
机身对插件



PG:
VTX Hatch/
图传舱盖



PB:
Motor mount/
电机底座



PC:
ESC hatch/
电调舱盖



PD-L/PD-R:
Flight Light cover/
航灯盖

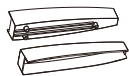

PH-L/PH-R
V-tail Base/
V尾装配件



PJ-L/PJ-R:
V-tail control horn/
V尾舵角



PI:
Landing Skid/
机尾着落靴

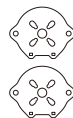

PA:
Motor base/
电机座



P1:
Servo cover/
摆臂保护罩



P2:
Camera Mount/
摄像头支架



P3:
Control horn/
舵角

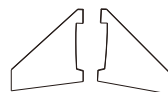

P4:
Wing fence/
翼刀

KIT、PNP、FPV Installation / KIT、PNP、FPV 版本安装指南

1

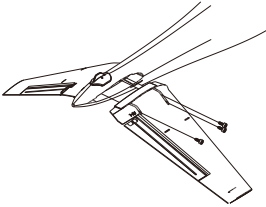

Install the V-tail on the fuselarge
将V尾与机身连接并用螺丝固定好

2

Install the V-tail servo
安装V尾舵机

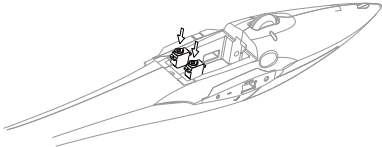

3

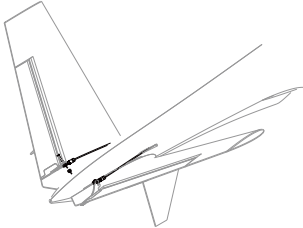
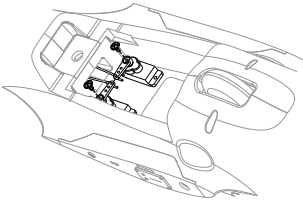

Install the push rods.
将Z拉杆安装到舵机摆臂上，再回中舵机安装摆臂。

4

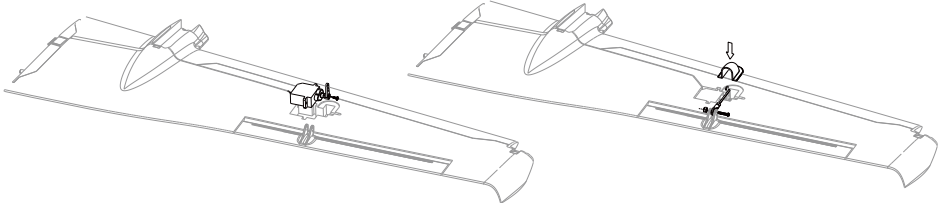

Install the aileron servo, push rods and servo arm cover.
安装左右机翼舵机、安装拉杆保护罩。

RTH/RTH FPV Installation/安装指南

1

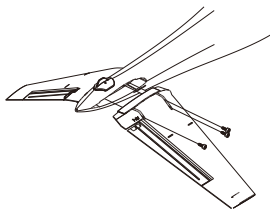

Install the V-tail
将V尾与机身连接并用螺丝固定好

2

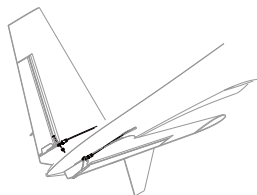
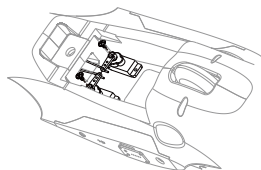

Installed the push rods.
先将Z拉杆安装到舵机摆臂上，再回中舵机安装摆臂

3



Install the INAV configurator then plug to PC
下载INAV地面站，安装接收机，连接地面站

4

Check INAV Configurator the receiver type,
then assign the channel and mode
连接INAV地面站，检查接收机设置、模式开关分配设置
检查舵机输出是否正确

5

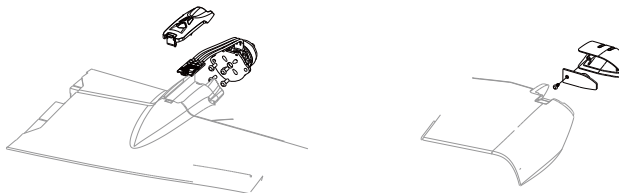

Install the Motor,ESC and LED
 将电机、电调、LED灯，安装到左右机翼上

6

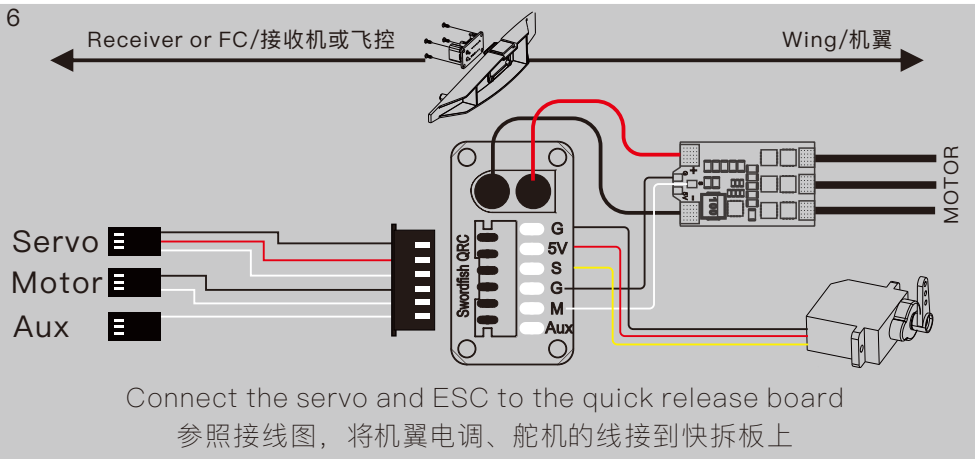

Connect the servo and ESC to the quick release board
 参照接线图，将机翼电调、舵机的线接到快拆板上

7

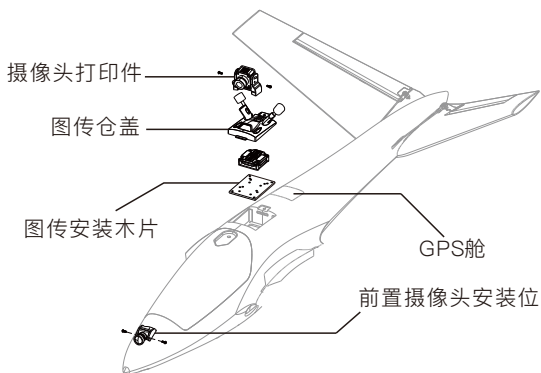

Install the FC and VTX system if needed
 根据需求安装图传摄像头和其他外设

8

Install the wing
 合并左右机翼，进行飞行前调试，完成安装。

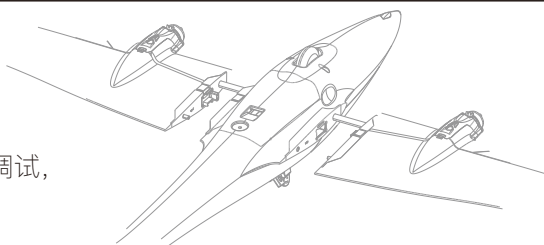

ATOMRC F405 NAVI Information/飞控说明

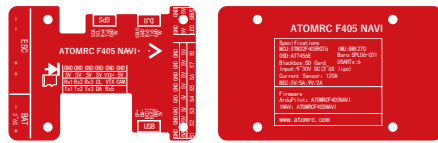
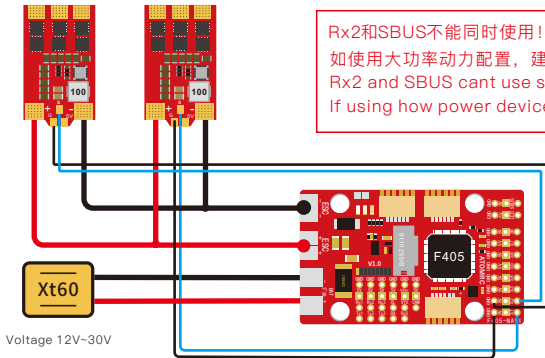
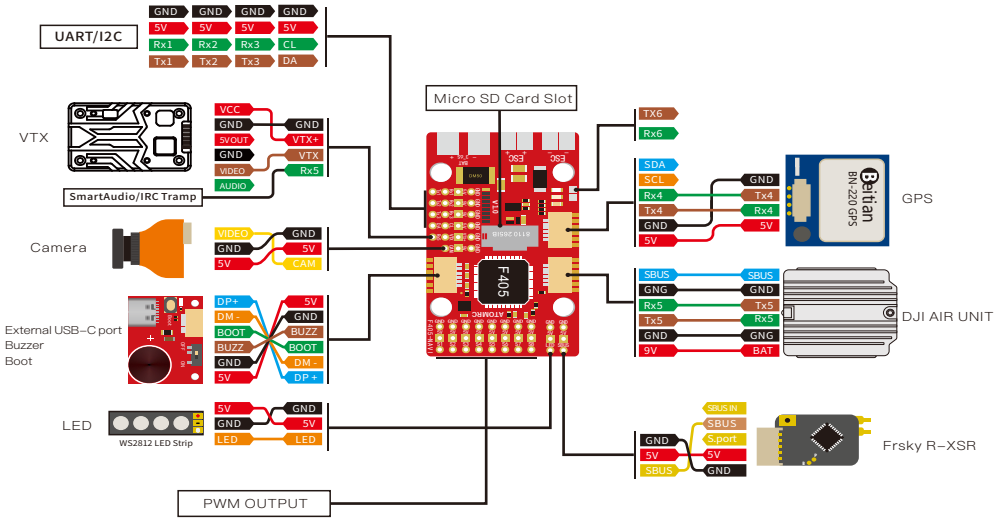

Mounting size: 30mmX24mm*Φ3mm

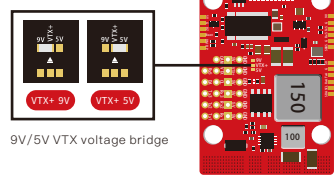

SIZE: 50mmX30mmX12mm

Tx500 VTX User manual/TX500图传说明书

ATOMRC Tx500 VTX Wiring Diagram/TX500图传接线图

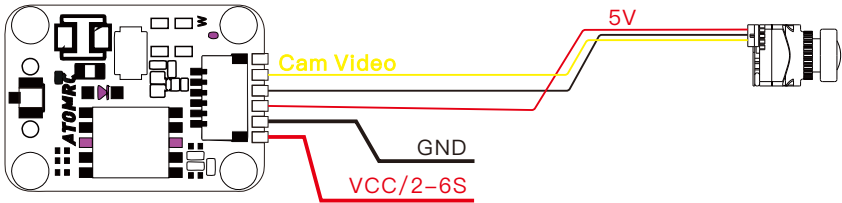

VTX Setting/图传设置

1. Hold button 3 seconds into setting mode.
 2. In setting mode, short press the button to change band.
 3. Then hold button 3 seconds into CH setting mode, short press button to change CH.
 4. Hold button 3 second to get into Power setting mode, there is short bar on LED, short press to switch power, 1 bar means 25mW, 2 bar means 200mW, 3 bar means 500mW.
1. 长按设置按键三秒，进入波段设置模式。
 2. 在设置模式下，短按按键切换波段。
 3. 再次长按按键三秒钟，进入频道切换模式，短按按键切换频道。
 4. 再次长按按键三秒钟，进入切换功率模式，短按按键切换功率，数码管一条为25mw，两条为200mw，三条为500mw。

Band	Channel							
	1	2	3	4	5	6	7	8
Band A	5865	5845	5825	5805	5785	5765	5745	5725
Band B	5733	5752	5771	5790	5809	5828	5847	5866
Band E	5705	5685	5665	5645	5885	5905	5925	5945
Airwave/FS	5740	5760	5780	5800	5820	5840	5860	5880
Race Band	5658	5695	5732	5769	5806	5843	5880	5917
L Band	5362	5399	5436	5473	5510	5547	5584	5621

Voltage input/电压输入范围: 2~6S Lipo Power/功率: 25/200/500mw Switchable

Power consumption/功耗: 9V 1.1A

Frequency/频率: 5.3~5.9Ghz

ESC Information/电调说明

Throttle calibration /电调油门校准

1.The ESC included with the model has a safe start.If the motor battery is connected to the ESC and the throttle stick is not in the low throttle or off position,the motor will not start untill the throttle stick is moved to the low throttle or off position.

2.Power on the ESC(The ESC must connect to the motor and Receiver). The motor will emit a series of beeps, after the beeps, set the the throttle stick the the minimum, the motor will emit a series beep again. now the ESC calibration is done.

1.电调具有安全启动保护功能，当电机、电池连接电调后，电调信号未处于最低位置，电调油门输出不会启动。

2.电调油门校准：请先拆卸螺旋桨，将油门摇杆移动到最高位置后通电，当哔哔声结束后，迅速将油门摇杆移动到最低位置，哔哔声音结束，油门校准成功。

ATOMRC Exceed BLS 30A 5VBEC ESC Wiring Diagram

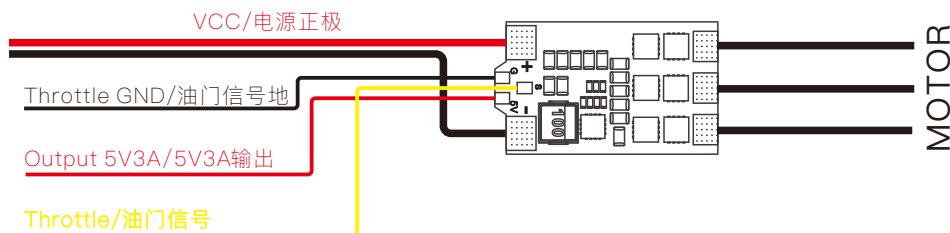

Voltage input/电压输入范围: 2~4S Lipo

Max Current/最大电流: 35A

Output/输出: Built in 5V 3A BEC/内置5V 3A BEC

Size/尺寸: 29.5*17.5mm

Please download the latest user manual at
www.atomrc.com

