

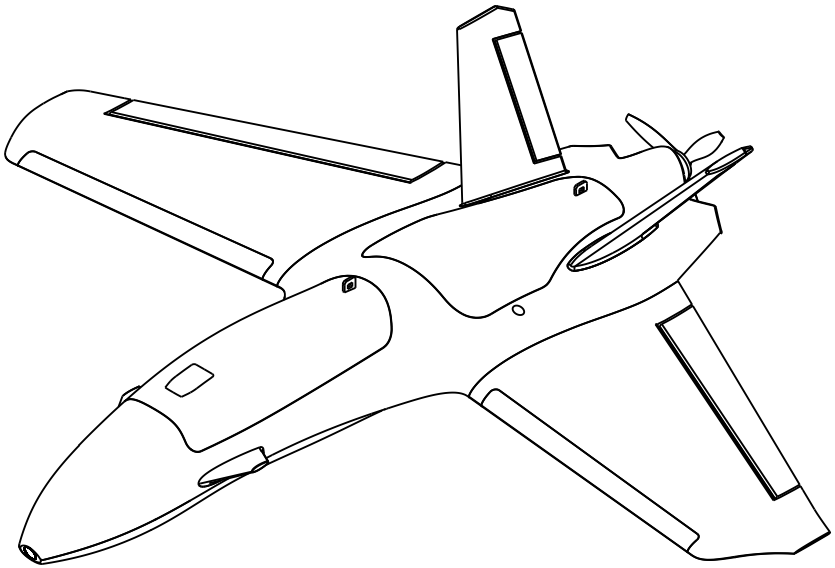

# User Manual

## Dolphin

### 海豚



## Introduction/简介

The Dolphin is sweep forward fly wing, with elegant design, the dolphin can fly stable both on high speed and low speed, the large fuselage can give use lots of space to install the electronics, the detachable wing made the wing easy for transport, V tail made the wing more stable for cruising.

海豚是前掠式飞翼布局飞机，针对FPV飞行所搭载的设备载重，极佳的优化了异形和装配空间。能够满足高速飞行的同时，低速也能获得非常优秀的滑翔性能。可拆卸的机翼使机翼便于运输，V型尾翼使机翼在巡航时更加稳定。

## Specifications/规格

Specifications/规格	
Wingspan/翼展:	845mm
Length/长度:	710mm
WingArea/翼面积:	15.24dm <sup>2</sup>
Material/材料:	EPP
Recommend Motor/推荐电机:	2306 2000KV
Recommend ESC/推荐电调:	30A 2~4S
Recommend Propeller/推荐螺旋桨:	7040
Servo/舵机:	9g Servo*2PCS
Recommned Battery/推荐电池:	4S 1800~2200mAh Lipo

Dolphin Packing List/海豚配置表			
Version	KIT LITE	KIT	PNP
Description (EN)	Un-assembled KIT	Pre-Build KIT	Assembled KIT
	Woodplate		ATOMRC 2306 2000kv Motor*1Pcs
	Screws and Nuts		ATOMRC BLS 30a ESC*1Pcs
	Sticker and user manual		9g Servo*300mm*2Pcs
			7040 Prop
The specs will be slightly adjusted according to different actual specs are subject to the latest manual and real objects.			
规格描述 (CN)	泡沫配件全不组装 (用户需要自备胶水组装)	预组装好的KIT	包括KIT的所有配件 (电子设备不组装)
	木片		ATOMRC 2306 2000kv 电机*1个
	基础安装螺丝、拉杆套件		ATOMRC BLS 30A 电调*1个
	贴纸、说明书		9G舵机*300mm*2个
			7040螺旋桨*1个
配置参数根据不同的出货批次, 会有细微的调整, 实际配置参数以官网的最新说明和实物为准。			

# KIT Contents

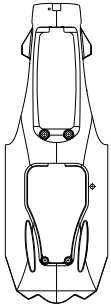

A

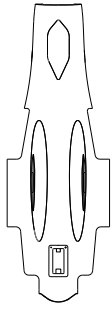

B

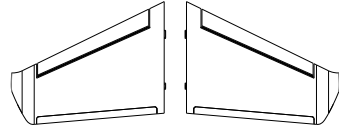

C



D



E



F



G



H

A: Fuselage  
上机身

B: Fuselage  
下机身

C: Wing  
机翼

D: Tail  
垂尾

E: Front Hatch  
前舱盖

F: Rear Hatch  
后舱盖

G: Nose  
尖机头

H: Gopro Hatch  
Gopro机头

## KIT Lite Installation/KIT Lite 安装指南

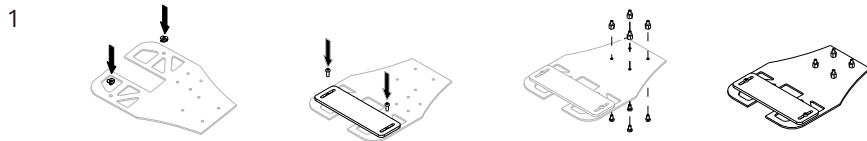

Install the standoff and nuts, need glue the nylon screw under the board.

安装机舱螺母及螺丝，机舱木片底部螺丝需先用胶水固定。

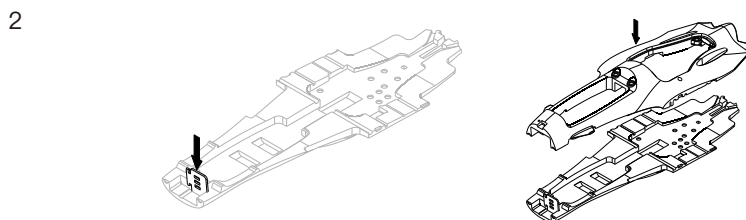

Glue the gopro mount plate, then glue the fuselage.

粘接GOPRO安装木板，然后粘接上下机身。

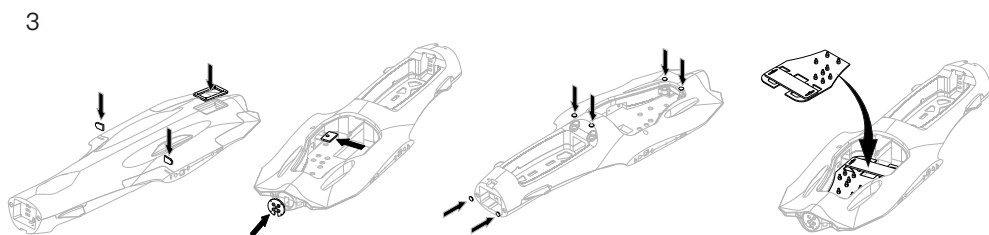

Install the battery strap , glue the battery mount board to the fuselage.

安装电池固定木片，安装舱盖扣。

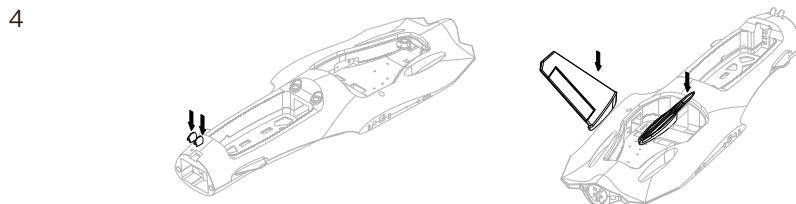

Install the Camera mount plate, and the V tail.

安装机头相机安装片，粘接V尾。

5

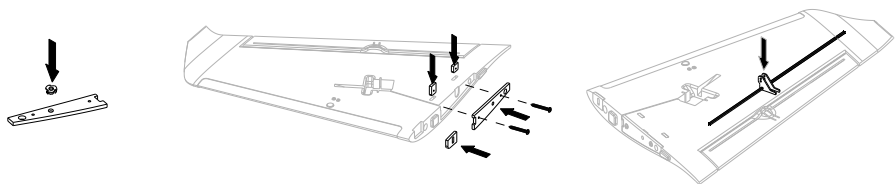

Install side plate of the wing, then install the control horn .  
安装机翼侧边木片，机翼舵角。

---

6

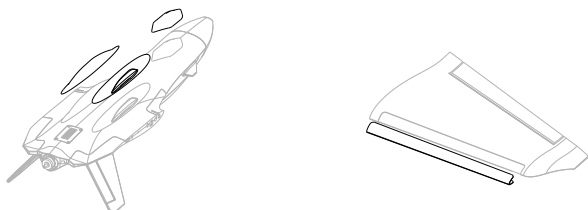

Glue the plastic protection parts on the wing and the bottom .  
粘接机翼机腹塑料保护片。

---

7

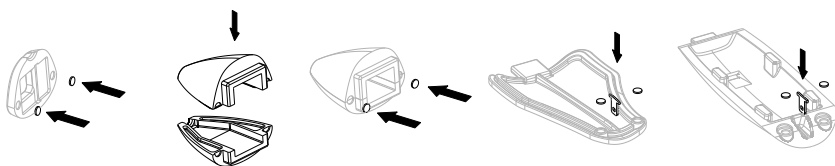

Install the magnet on the hatch, glue the sharp nose.  
安装各个舱盖磁铁，粘接尖机头。

## KIT/PNP/FPV Installation/安装指南

1

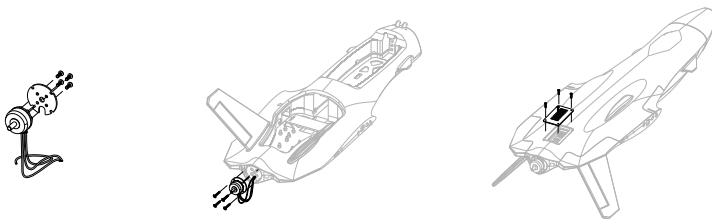

Install the motor and ESC.  
安装电机电调。

2



Install the servo and push rods, then install the rudder.  
将舵机安装到垂尾、平尾，居中调试后，安装拉杆。粘合左右垂尾。

3

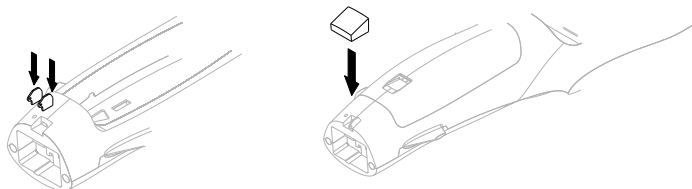

User can choose carbon plate to install the camera or just use foam to fill.  
飞机机头位置，可以选择安装摄像头固定碳片或者泡沫填充。

4

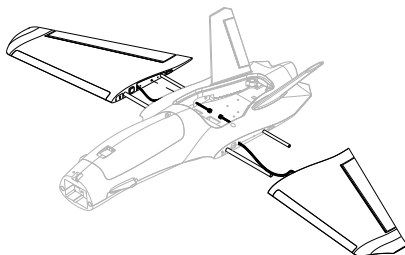

Install the wing to the fuselage.  
将左右机翼安装到机身。

5

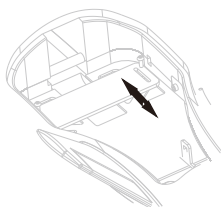

When Gopro is installed, adjust battery slider to adjust balance.  
安装Gopro时，需要将电池安装到后面，通过滑块调平。

---

6

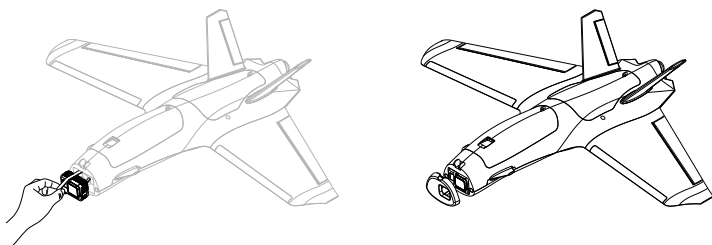

To install Gopro, use rubber band to lock the gopro then install the hatch.  
若安装GOPRO，需用橡皮筋固定住GOPRO，然后盖上机头相机盖。

---

7

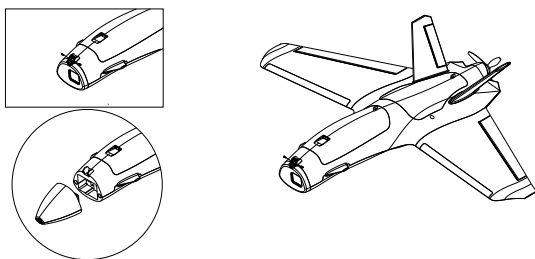

Install the Nose and Cam.  
安装摄像头机头。

---

8

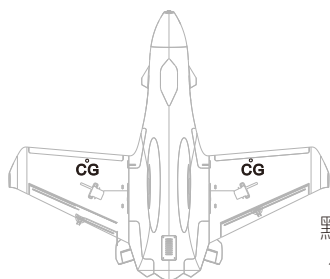

The CG is marked under the wing, you can move the CG 3-4mm to get better control.  
海豚的重心点、标记在机翼底部，默认更适合新手更易起飞，在默认重心点完成首飞后，你可将重心点往前移3~4mm，从而获得更好的手感。



# ESC Information/电调说明

## Throttle calibration /电调油门校准

1.The ESC included with the model has a safe start.If the motor battery is connected to the ESC and the throttle stick is not in the low throttle or off position,the motor will not start untill the throttle stick is moved to the low throttle or off position.

2.Power on the ESC(The ESC must connect to the motor and Receiver). The motor will emit a series of beeps, after the beeps, set the the throttle stick the the minimum, the motor will emit a series beep again. now the ESC calibration is done.

1.电调具有安全启动设置，当电机、电池连接电调后，电调信号未处于最低位置，电调输出不会启动。

2.电调油门校准：请先拆卸螺旋桨，将油门摇杆移动到最高位置后通电，当哔哔声结束后，迅速将油门摇杆移动到最低位置，哔哔声音结束，油门校准成功。

## ESC Wiring Diagram /电调接线图

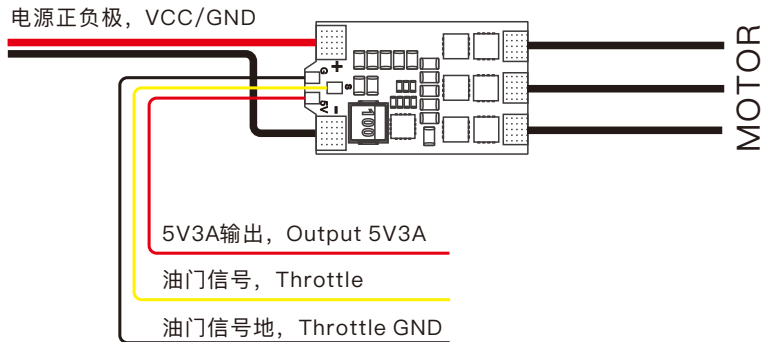

Voltage input/电压输入范围: 2~4S Lipo

Max Current/最大电流: 35A

Output/输出: Built in 5V 3A BEC/内置5V 3A BEC

# VTX Tx15 Uermanual/图传说明书

## Tx15 Wiring Diagram/Tx15图传接线图

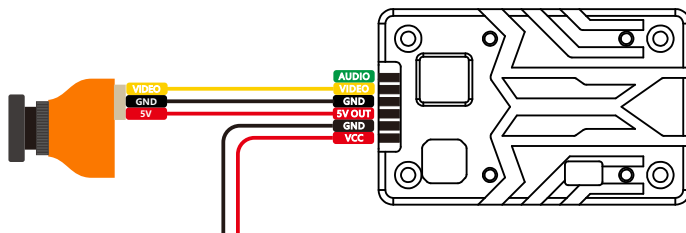

Please make sure antenna is installed before power on, otherwise the VTX will be fried!!!  
图传发射机通电前务必确认天线已安装妥当，否则发射线会烧毁!!!

## Tx15 Specs/Tx15规格参数

Voltage input/电压输入范围: 2~6S Lipo Power/功率: 200/800/1500mw Switchable  
Power consumption/功耗: 9V 1.1A Frequency/频率: 5.3~5.9Ghz

Band	Channel							
	1	2	3	4	5	6	7	8
Band A	5865	5845	5825	5805	5785	5765	5745	5725
Band B	5733	5752	5771	5790	5809	5828	5847	5866
Band E	5705	5685	5665	5645	5885	5905	5925	5945
Airwave/FS	5740	5760	5780	5800	5820	5840	5860	5880
Race Band	5658	5695	5732	5769	5806	5843	5880	5917
L Band	5362	5399	5436	5473	5510	5547	5584	5621

## VTX Setting/图传设置

1. Hold button 3 seconds into setting mode.
  2. In setting mode, short press the button to change band.
  3. Then hold button 3 seconds into CH setting mode, short press button to change CH.
  4. Hold button 3 seconds to get into Power setting mode, there is short bar on LED, short press to switch power, 1 bar means 200mW, 2 bar means 800mW, 3 bar means 1500mW.
1. 长按设置按键三秒，进入波段设置模式。
  2. 在设置模式下，短按按键切换波段。
  3. 再次长按按键三秒钟，进入频道切换模式，短按按键切换频道。
  4. 再次长按按键三秒钟，进入切换功率模式，短按按键切换功率，数码管一条为200mw，两条为800mw，三条为1500mw。

Please download the latest user manual at  
[www.atomrc.com/pages/download](http://www.atomrc.com/pages/download)

