

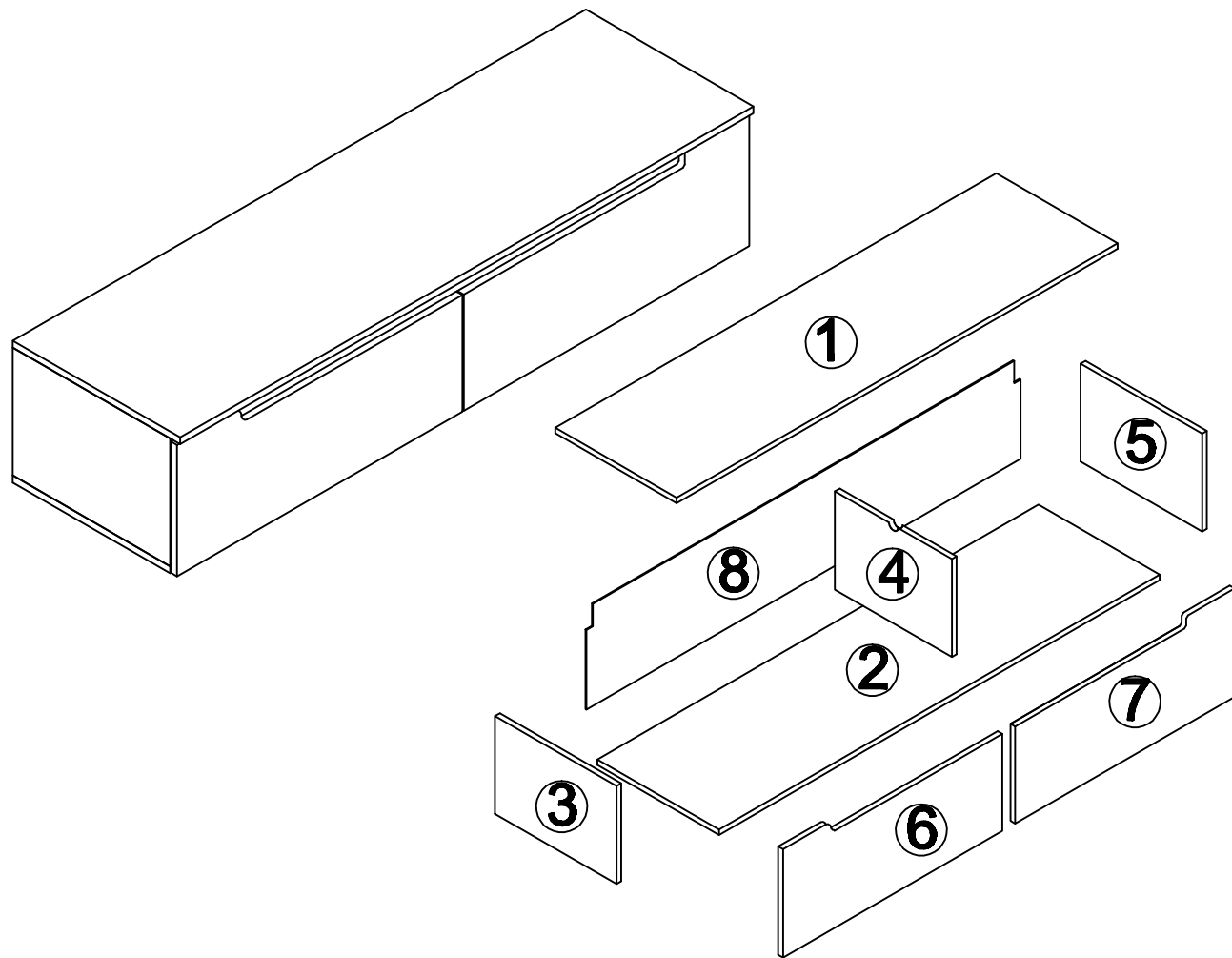

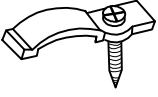

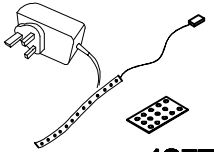

GTV009W

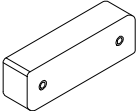
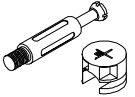
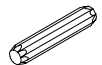

NO.	SIZE	QTY	CTN
①	1400*350*15	1	GTV009W
②	1400*383*15	1	GTV009W
③	270*333*15	1	GTV009W
④	270*319*15	1	GTV009W
⑤	270*333*15	1	GTV009W
⑥	697*282*15	1	GTV009W
⑦	697*282*15	1	GTV009W
⑧	1378*280*3	1	GTV009W

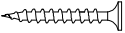
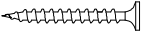
K  3PCS	L LED  1SET
I  2PCS	J  5PCS

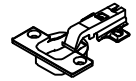
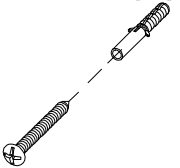
A  12PCS	B  12PCS	C 3.5*14  34PCS	D 3.5*25  10PCS	E 3.5*30  4PCS	F  F1 F2 2SET	G  4PCS	H 8*60  4SET
---	---	--	---	---	--	--	---

