

MAXOAK®



**BLUETTI**

**400Wh Portable Power Generator**  
User Manual

Please read this manual before use and follow its guidance. Keep this manual for future reference.

## Product Overview

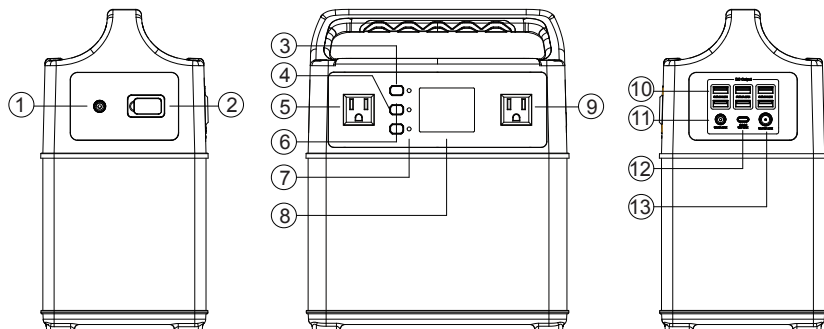

- |                                   |                               |
|-----------------------------------|-------------------------------|
| 1. PV/Adapter Charging port(6530) | 8. LCD Display                |
| 2. CAR Jump Starter Port          | 9. AC Outputs                 |
| 3. Main power On/Off Button       | 10. USB 5V Output ports(6mm)  |
| 4. DC Power On/Off Button         | 11. 12V/5A Output port(5521)  |
| 5. AC Outputs                     | 12. Type-C QC3.0 Output port  |
| 6. AC Power On/Off Button         | 13. 12V/10A Output port(7909) |
| 7. Power On/Off Indicator Lights  |                               |

### LCD Display

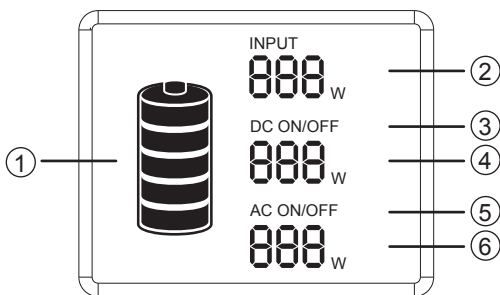

- |                         |                    |
|-------------------------|--------------------|
| 1. Battery Level        | 4. DC Output Power |
| 2. Input Charging Power | 5. AC ON/OFF       |
| 3. DC ON/OFF            | 6. AC Output Power |

---

The LCD Battery Display indicates the charge level. There are 5 segments of the battery, approximating 20%~40%~60%~80%~100% capacity. During using, segments will disappear from the display, indicating the remaining capacity. When charging it, you will notice a battery segment blinking with 1 second interval. This indicates the current charge status and the number under INPUT shows the real-time charging power. Once it is fully charged, all battery segments will be lit and remain solid.

**Note:**

1. If the product malfunctions, error codes(E\*, refer to TROUBLESHOOTING which will be discussed below) would be displayed on screen.
2. Backlight would be turned off by itself when the product remains idle for a certain period of time. Click on a button to turn on the backlight.

**Charge your PPS when there is only one battery segment!**

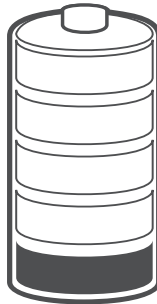

## Warnings

1. Please read the warning section carefully before use.
2. Avoid using this product when it is exposed to direct sunlight, rain or wet environment.
3. This product cannot be installed near radiator, oven or any other heat source.
4. Place the product in a stable and secured area.
5. Please use dry cloth to clean this product.
6. Please do not alter or disassemble this product.
7. Keep away from fire. If a fire hazard occurs, use dry powder fire extinguisher on this product. Using water fire extinguisher on this product may lead to electric shock.
8. Operating temperature: 0°C-40°C; Operating humidity: 5%-90%

---

## Storage and Maintenance

1. Please fully charge the product before storage and charge it at least once every 3 months.
2. Store this product in a cool, dry, well-ventilate and well-spaced area. Keep the product away from water, flammable gas, corrosive material, metal dust and salt. Storage temperature:0°C-40°C.
3. Failure to use, store and maintain the product according to the instruction would void the warranty.

## Unboxing

Before opening the parcel, please check whether if the parcel is damaged or not. If the product is damaged during delivery or if any items went missing upon arrival, please contact Seller customer service to get it solved. You should receive the following items:

Item	Number of item
Portable Power Supply	1
AC wall charger	1
Car charging cable	1
Solar charging cable	1
12V/10A output to car charging cable	1
Type-C to type-C cable	1
Car jump-starting cable	1
User Manual	1
Warranty card	1

### ● What to power with the portable power supply

**USB:** Smart phone,MP3 Players,Digital Cameras,Tablets,E-readers,etc.

**DC 12V Output Ports:** Dual ports for LED lamp mainly.

**Cigarette Lighter Socket:** Car on-board Fridges,12V appliances,etc.

**AC Output Port:** Electrical appliances(power rate under 300W),such as Televisions, Laptops,Cooker,etc.

---

## How to charge the product

There are 3 ways to charge the product, using AC adapter, solar charging cable or car charger.

### ● Charge with solar panel

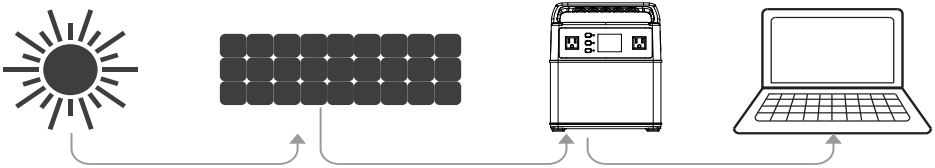

1. Power on the portable power supply by press master power button for 2 seconds.
2. Place your solar panel where it can get as much direct sunlight as possible.
3. Connect the solar panel by solar charging cable, then insert the Anderson plug of the cable into the solar charging port on the left side of the portable power supply. You can know the charging state from the LCD display.
4. You can chain multiple solar panels together to reduce solar recharge times. It is capable of taking in 120W of solar charging power. The open-circuit voltage of the solar panel should be from 14V to 40V.
5. It will stop charging when the battery full of energy, with the built-in advance system control circuit module.

### ● Charge with adapter

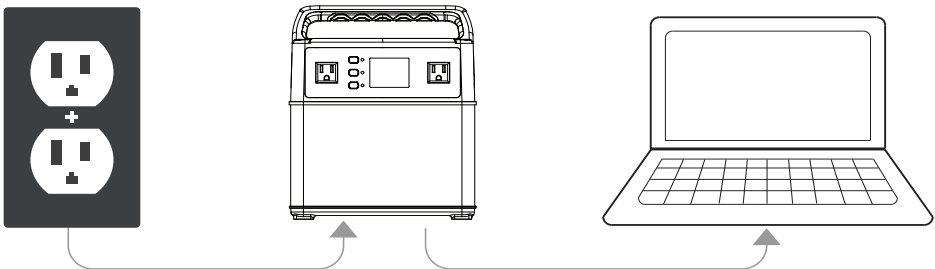

Power on the portable power supply by press master power button for 2 seconds. Please insert the DC head into the PV/Adapter Charging port of the product and then connect the adapter to the AC power socket. you can know the charging state from the LCD display. It will stop being charged when it's full of energy, with the built-in advance system control circuit module.

---

## ● Charge with car charger

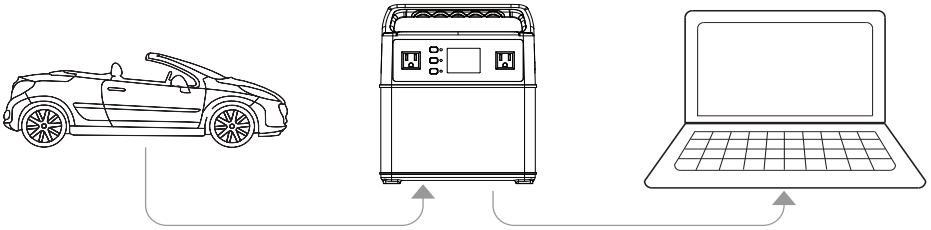

Power on the portable power supply by press master power button for 2 seconds.Plug one end of the car charger to your portable power supply, plug the other end to car cigarette socket of your car.You can know the charging state from the LCD display.

**Note:** Car cigarette socket of 12 vehicle can't charge the portable power supply fully,but the 24 vehicle can. It can't be charged when the 12 vehicle is not starting.

## How to use the product to charge other device

1. Press the master power button for 2 seconds to turn on the portable power supply,then the power indicator and LCD will be lit up.
2. Press the DC power button under the master button for 2 seconds to power DC device.Press the AC power button under the DC power button for 2 seconds to power AC device.(When not using certain ports,make sure to turn them off to conserve power)
3. Connect your device to the portable power supply.
4. You will know if it's powering other devices when the numbers on the LCD changes. The numbers indicate the amount of power your devices getting from the portable power supply.
5. Press the AC power button,DC power button,master power button for 2 seconds to shut down the AC output,DC output and main power supply respectively.
6. When the master power button is on while the DC and AC power button are off,main power supply will shut down automatically in 10 minutes.You need to press the master button for 2 seconds again to restart it.
7. The portable power supply will shut itself down when the battery capacity is lower than 10%.
8. Always remember to turn off the product if you don't use it.
9. If possible,keep your portable power supply fully charged before long-term non-use.

---

## ●50Hz/60Hz Frequency Selection(Factory Default Settings:60Hz)

Press the power switch for 2 seconds to turn on the machine, then press the DC power button and AC power button simultaneously to enter frequency regulation mode, LCD will display the current frequency. Click the AC power button to switch the frequency between 50Hz and 60Hz. Press the DC power button and AC power button simultaneously to exit frequency regulation mode. Automatically keep the setting before your next usage.

## ●Jump Start a car

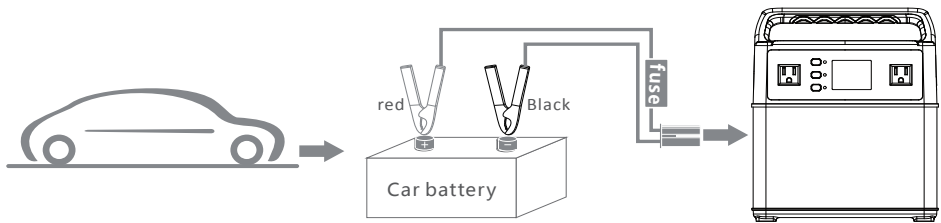

1. Make sure the gas engine displacement of the vehicle is not more than 4L. 2. Make sure the power is over 60%(four battery segments on).
3. Make sure the clamps of the battery clamps is not broken.

### Steps:

1. Plug the intelligent battery clamps into the jumping port of your portable power supply. If green and red lights are on simultaneously,the connection is confirmed to be correct.
2. Connect the positive and the negative polarities of the battery clamps to the positive and the negative polarities of battery(Red to +,black to -).If the green light is on ,then you can start you car. If green and red lights are on simultaneously,you can try to open the head lamp of vehicle or air- conditioner(the clamps need to be activated).
3. Turn the auto key to start the auto
4. Disconnect the clamps with battery and the jumping port of your portable power supply.The first step and the second step can be exchanged.Only when the indicator light of the clamps turns to green,then you can start you car.

### Notice :

- 1.Before starting,make sure the red and black clips are clamped tightly to the battery poles of your car,keep the two clips with enough safety distance,to prevent the two

- from falling off or collision because of the engine vibration after car starting.
2. It is strictly prohibited to connect the red and black clip directly, otherwise it may cause accidents.
  3. Please keep away from the engine when starting the car to avoid any physical injury that may be caused by car engine running.
  4. Please remove the product from battery within 30 seconds after engine started, otherwise it might cause damage to the portable power supply or even cause an accident.
  5. Please check the battery capacity before every re-start. Make sure the power is over 60% (four battery segments on).
  6. People who are not familiar with this product (especially children) is strictly prohibited to use this function.

## Technical specification

Model		EB40	
Battery Capacity		400Wh(JP&UL)	400Wh(EU)
Battery Material		Lithium-ion Rechargeable Cell	
Battery model		INR18650	
Battery rated voltage		11.1V(3S14P)	
<b>Output</b>			
AC Output	Continuous Output Power (Max.)	300W	300W
	Peak output	600W	600W
	Rated output voltage	110Vac	230Vac
	Rated frequency	50/60Hz	50/60Hz
	Power factor	1	1
	Overload	100-150%@2min; >150%@10S	100-150%@2min; >150%@10S
	Self-consumption (No load)	<5W	<10W
	Max efficiency (>70% load)	88%	88%



12V/10A output port(7909)	Output voltage	12.6	12.6
	Rated output current	10A	10A
	Overload protection power	>140W	>140W
12V/5A output port(5521)	Output voltage range	10~12.6V	10~12.6V
	Rated output power	60W	60W
	Overload protection power	>65W	>65W
Type-C output port	Communication protocol type	QC3.0	QC3.0
	Output voltage range	3.6~12V(default 5V)	3.6~12V(default 5V)
	Rated output current	5V/2.5A, 9V/2A, 12V/1.5A	5V/2.5A, 9V/2A, 12V/1.5A
	Overload protection current	>3A	>3A
USB output ports(6pcs)	Output voltage	5V	5V
	Output current	3A	3A
<b>ACcharge</b>			
Charger (90W)		About 5Hrs	
<b>PV charge</b>			
Max. PV charge power (120W)		About 4Hrs	
PV input voltage range		12.6~40Vdc	12.6~40Vdc
voltage range		15-40Vdc	15-40Vdc
Max. input voltage		40Vdc	40Vdc
Max. input current		10A	10A
MPPT efficiency		99.50%	99.50%
Max. efficiency		>96%	>96%
Solar power charge type		MPPT	MPPT
<b>Main Unit</b>			
IP Rating		IP 21	
Working Condition		Relative Humidity: 5%-90%	
		Temperature: 0-40°C	
Dimensions		234*149*285mm	
Net Weight		5.6 kg	

---

## Frequently Asked Questions

### ●What type of battery?

Lithium-ion battery is much smaller and lighter weight than normal SLA battery and also cycles much longer time than normal SLA or AGM battery.It can last longer if you don't drain them completely.

### ●How do you know if your portable power supply is charged?

To check the charging state of your portable power supply, refer to the LCD Battery Display. When lit up, you will see a battery outline with five segments, indicating the current charge level. You can turn on the Battery Display by pressing the Master Power Button. It is OK to use the portable power station even when it's not fully charged.

### ●How do you know if your device will work with this product?

First, you need to determine the amount of power your device requires. This may require some research by yourself, examining the user guide for your device should suffice. Second, you will need to check the capacity for the individual output ports. For example, the AC port is monitored by an inverter that allows for 300W of continuous power. This means if your device is pulling more than 300W for an extended period of time, the portable power supply will shut off.

### ●Depth Of Discharge(DOD)

To prolong battery life, we set a DOD of 80% for this portable power supply, which means only 80% of 400Wh can be discharged.

### ●Did it Support Charge and Discharge Simultaneously?

Yes, this power station can be discharged while charging. But for better protect the life-span of the battery, we do not suggest you use this pass-through function long term.

### ●Can I Charge the Power Station with Two Solar Panel in Series?

Yes, you can. But make sure the total open circuit voltage (OCV) is no more than 40V. otherwise it may power off automatically or cause damage.

### ●How to Extend the Charge Time for CPAP?

We suggest turn off the humidifier/heater and set a lower pressure to get a longer charge time for CPAP.

---

## Trouble Shooting

If your device can be charge with this portable power supply, follow these steps:

1. Make sure the Master Power Button is turned on.
2. Ensure the output port has been turned on. The green LED light indicating its state should be lit up.
3. Check the battery capacity display. If it's at 20% or below, you need to charge the portable power supply.
4. Verify your device is suitable to be charged with this product. All the output ports have their own max power capacity. Check them to ensure your device is compatible. If you are still experiencing trouble with this product after checking the TROUBLESHOOTING as below, please contact us.

Error codes	Cause	Solution
E01	Over Temperature Protection	1, Check the ambient temperature if higher than 40°C. Output will start again if the generator cools down.
E02	Battery Over Voltage Protection	Disconnect the charger and restart it;
E03	Battery Damage Protection	Please contact customer service.
E04	1st Battery String Over-Voltage	Disconnect the charger and restart it
E05	2nd Battery String Over-Voltage	Disconnect the charger and restart it
E06	3rd Battery String Over-Voltage	Disconnect the charger and restart it;
E07	1st Battery String Low Voltage	Charge the unit in time, restart it after fully charged
E08	2nd Battery String Low Voltage	Charge the unit in time, restart it after fully charged
E09	3rd Battery String Low Voltage	Charge the unit in time, restart it after fully charged
E10	Discharge low temperature protection	Check the ambient temperature whether it's lower than -20°C

E11	Battery Low Voltage Protection	Charge the unit in time, restart it after fully charged;
E12	Inverter Over Current Protection	Check if the AC output overload or short circuit
E13	Inverter Over Load Protection	Check if the AC output overload
E14	Inverter Short-Circuit Protection	Check if the AC output overload or short circuit
E16	Charging Over Voltage protection	Check if the input voltage excess the max input voltage
E19	12V6A Output Over Current Protection	Check if the 12V/6A output overload or short circuit
E20	12V6A over load protection	Check the if the 12V6A is over load
E21	12V10A Output Over Current Protection	Check if the 12V10A output overload or short circuit
E22	12V10A overload protection	Check if the 12V10A output overload
E23	5V output Over Current Protection	Check if the output overload or short circuit
E24	5V output Over Current Protection	Check if the output overload or short circuit
E25	Battery over temperature protection	Check if the environment temperature is higher than 40°C . Generator will recover to normal work after it cools down.

## Warranty

Our company provides customers with warranty of 12 months from the date of purchase.

## Contact us

For any inquiries or comments concerning our products, please contact seller(**service@kayomaxtar.com**) and we will respond as soon as possible.