

# **500Wh Portable Power Station**

## User Manual

# Forehead

## **Please note the below comments while reading the instruction manual**



- Due to product improvements, partial changes in appearance and specifications may be made without prior notice.
- This manual cannot be copied or reproduced without the use of the individual.
- If the product requires maintenance, please contact the local designated system installation and maintenance personnel.

## **Disclaimer**

- The company shall not be liable for any damage caused by force majeure such as fire, typhoon, flood, earthquake or customer's intentional negligence, misuse or use under other abnormal conditions.
- Defect caused by the non-standard connectors is not compensable.
- The company does not assume any responsibility for damage caused by not operating the product in accordance with the instructions in the operating instructions.
- This product is not suitable neither for atomic energy equipment, aerospace equipment, transportation equipment, medical equipment, etc. which are related with personal safety or equipment relies heavily on uninterrupted electricity must be guaranteed. It is assumed that the product is used on the above equipment or machine, the company is not liable for any personal accidents, fire accidents, or malfunctions caused by the malfunction of the product.

# Safe Operating Guidelines



## Please be sure to observe the following for safe use

 <b>DANGER</b>	The situation in which people die or are seriously injured to a large extent due to improper operation
 <b>WARNING</b>	The possibility of death or serious injury due to incorrect operation)
 <b>ATTENTION</b>	Human or properties damage may occur due to incorrect operation





**Serious Injury:** refers to blindness, injury, electric shock, fracture, poisoning and other sequelae, and to be hospitalized or regularly need to go to the hospital for treatment.









**Injuries:** refer to injuries, burns, electric shocks that do not require hospitalization or go to the hospital regularly for a long time.

**Properties Damage:** refers to damage to houses, household property and livestock, pets.









	It indicates that attention should be paid to fire, rupture and high temperature when operating the product. Specific attention is described in the figure.
	This means that this behavior is prohibited when operating a product. Specific prohibited content is described in the icons or text in or near the icons.
	Represents the mandatory operation of the product in accordance with the instructions. Specific mandatory content is described in graphics or text in or near the figure number.



- In order to use the product safely, a clear note label was pasted. Please use it with the contents and labels of this manual.
- Please do not make the labels sticking on this product dirty or fall off.











 <b>DANGER</b>	
	Please do not disassemble, repair or transform, which may cause electric shock, heat, fire and other dangers.
	Do not put the product near the fire source or put it into the fire or heat, which will cause fire or burns and other dangers.
	This product can not be charged and used in dew, bathhouse, rain and other places; do not use water to clean the product, it will cause electric shock, heat, fire and other dangers.
	Do not touch this product or connector plug when your hands are wet. It may cause electric shock hazard.

	Do not use metal to contact AC output interface. It may cause electric shock, fever, fire and other dangers.
	Do not wipe the liquid inside the eye. After washing with clean water, please see a doctor immediately. It may cause the risk of blindness.
	Please do not use it as general waste disposal. Electricity shock, heat and fire may occur in the garbage collection truck or in the garbage collection truck.
	Do not use AC connections other than those specified. It may cause electric shock, fever, fire and so on.
	Please confirm the rated specifications of the connection interface or the connecting machine, and do not exceed the specifications. It may cause electric shock, fever, fire and so on.
	Please do not have a strong impact on the product such as a drop or a hammer strike. It may cause electric shock, heat, fire or damage to the unit.
	Do not place, store, and use in places that are prone to falling or dropping (such as high shelves). It may cause electric shock, heat, fire or damage to the unit.
	Do not move the product while it is charging or in use. Due to vibration and shock during movement may cause heat or fire or electric shock or damage to the unit.

 **Warning**

	Please keep the place clean for use and storage. Powder or small metal contact terminal may cause short circuit, accidents such as smoke or fire.
	Be sure to check before use. In case of any abnormality such as breakage, crack, leakage, fever and AC line breakage, please stop using the product immediately.
	When AC wire is damaged, please pay attention to operation. Do not move the AC wire. Do not unplug the AC wire from the input port. Keep the AC wire away from the heat source. Do not trample or pull the AC wire, etc that would lead to AC wire damage. These are the causes of AC wire damage, heat, fire, electric shock.
	Do not let children use this product. Or it may cause accidents or injuries.
	Do not use if the interface cannot be fully plugged in due to loose or deformed interface, otherwise which may cause electric shock, heat and fire.
	Please do not use it on the beach or in dusty places. Or it may cause smoke, fire.
	Please do not use and keep in the car, trunk, loading table or high temperature place under direct sunlight. Otherwise, it may cause product failure obstacles or deterioration or cause fever.
	When the liquid inside the product sticks to the skin or clothes, please wash it with water immediately. Otherwise may cause the skin injury and so on.

	Remove the AC cable from the socket when lightning strikes during charging. When it thunders, a large current from the socket may be generated into a fever, fire, fire and other accidents.
	Please charge in the specified voltage range (AC 100-240v). Otherwise, it may cause heating, fire, fire and other accidents.
	Please do not put the product in reverse or sideways when using and storing. Otherwise may cause leakage, heat, fire, fire and other accidents.

 <b>Note</b>	
	Please stop using the product immediately when there is any abnormality such as rusting, peculiar smell, fever, etc.
	The transportation of the product shall conform to the provisions of laws and regulations of dangerous goods. The built-in lithium ion battery capacity is more than the United Nations regulations (100Wh), therefore, the product must be packed, labeled and declared in accordance with IATA(international air transport association) regulations when transported by air or ship. Please consult with the shipping company for details.
	When transporting the product with a car, etc., please fix the product so that it cannot be moved. Otherwise it May cause damage to the product, resulting in electric shock, heat, fire, etc.
	Do not allow this product and the AC cable to get wet with water or other liquids. It may cause short circuit, heat, fire, etc.
	Please charge, use and storage this product under 0-40°C , otherwise may cause poor performance or heat up.
	In case of accidental fall and impact, the body may be damaged due to electric shock, heat, fire, etc., please stop using it immediately. To prevent accidents, please contact the local designated system installation and maintenance personnel immediately.
	Please carefully read the operating instructions of the electrical products to be connected. Failure to operate the electrical products may result in accidents or injuries.
	Before connecting electrical products, please make sure that the electrical products are stopped (power off), and sudden start of electrical products may cause accidents or injuries.
	Be sure to turn off the main power button during storage to prevent unnecessary discharge of the battery and prevent electric shock.

Please read this manual before use and follow its guidance. Keep this manual for future reference

# 1. Packed Items

Before opening the package, please check whether the package is damaged or not, after opening the package, please check whether the product appearance is damaged or lack of accessories.

No.	Item	Quantity
1	Portable Power Station	1
2	AC adaptor (including AC charging cable)	1
3	Cigarette lighter cable( cigarette port to DC7909 connector male)	1
4	MC4 cable (MC4 connctor to DC 7909 connector male )	1
5	Type-C cable	1
6	User manual	1
7	Warranty card	1
8	Certificate of QC PASS	1

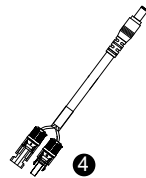
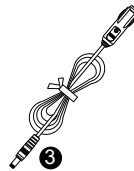
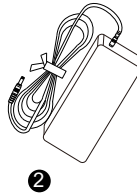
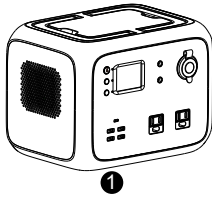

 **Note:** picture is only for reference, pls take the product as the standard.

## 2. Function Introduction

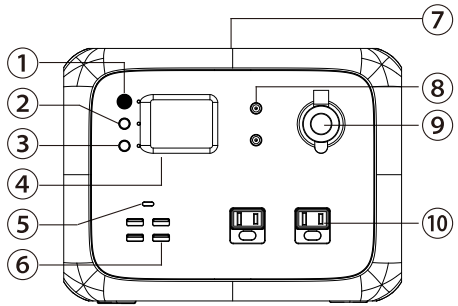
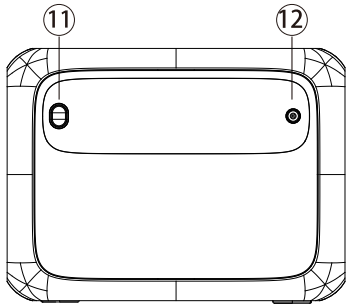

- 1. Main power button
- 2. DC power button
- 3. AC power button
- 4. LCD screen
- 5. Type-C PD output port
- 6. USB output port

- 7. Wireless discharging plate
- 8. DC 12V 5521 output port
- 9. DC12V car ignitor output port
- 10. AC output port
- 11. LED light button
- 12. Charging port

### LCD Screen

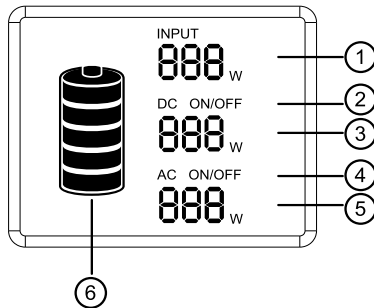

- 1. Charging power
- 2. DC ON/OFF
- 3. DC output power

- 4. AC ON/OFF
- 5. AC output power
- 6. Battery capacity indicator

### LCD Battery Display:

The LCD Battery Display indicates the charge level. There are 5 segments of the battery, approximating 20%~40%~60%~80%~100% of capacity. During using, segments will disappear from the display, indicating the remaining capacity. When charging it, you will notice a battery segment blinking with 1 second interval. This indicates the current

charge status and the number under INPUT shows the real-time charging power. Once it is fully charged, all battery segments will be lit and remain solid.

⚠ **Note:** If the product malfunctions, error codes would be displayed on screen.

### 3. Charging Instructions

⚠ **Note:** Please charge the product to 100% before using.

When charging the product, the battery capacity display icon on LCD screen will be on dynamic status, after the battery is charged fully, the display icon will on static status.

#### How to charge this product

##### •Solar Panel charge the product

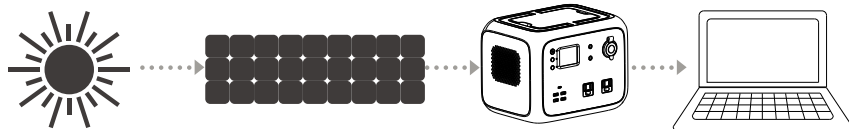

(1) Choose suitable solar panel (DC12-40V/120W)

(2) Put the solar panel under strong sunshine, face to the sun positively.

(3) Take the part MC4 cable, connect the solar panel and the product.

(4) When the product is charged fully by the Solar, it will stop charging automatically. Please take out the charging cable, and turn off the product.

⚠ **Note:** Please make sure the cable connecting is correct and stable, or will cause the connector in high temperature status or sparking.

⚠ **Note:** Please charge the product under 0~40°C temperature environment.

⚠ **Note:** During the charging, it is normal situation if the product is getting a little bit hot.

⚠ **Note:** The charging time is different when light intensity is different.

⚠ **Note:** Make sure that the positive and negative poles of solar panels are connected correctly. Refer to the following connection chart.

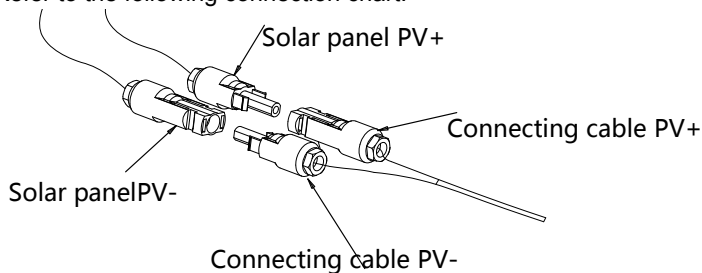

##### •AC charger charge the product

⚠ **Note:** Always use the standard AC charger that comes with the product.



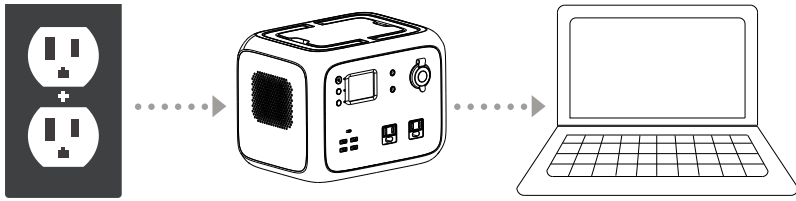

- (1) Connect the product and socket with the AC charger in the package.
- (2) please unplug the charger when charging completed.(it takes about 6-7hrs to fully recharge the product if using 90W AC adapter charger)

⚠ **Note:** It is normal for this product to get hot during charging.

⚠ **Note:** Make sure that the wiring is in good contact, otherwise the contact terminals may melt or ignite at high temperatures.

#### ●Car charger charge the product

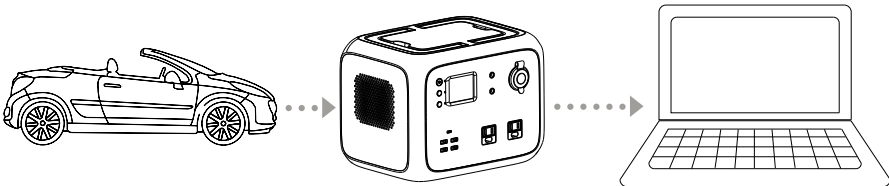

- (1) Connect the product and the cigarette lighter socket with the cigarette lighter cable in package
- (2) Charge the product after starting the car.

⚠ **Note:** Make sure that the wiring is in good contact, otherwise the contact terminals may melt or ignite at high temperatures.

## 4. Discharge instructions

### ●Buttons operation

#### (1) Main power button

**Power on:** Short press the main power button, the power indicator lights, and the LCD screen lights up.

**Power off:** Press and hold the main power button over 2 seconds, the indicator will be off and the LCD screen will be off.

#### (2) DC power button

**DC power on :** Press and hold the DC button over 2 seconds, the DC indicator will light, and the LCD will display “DC ON”.

**DC power off:** Press and hold the DC button for over 2 seconds, the DC indicator will be off, and the LCD will display “AC OFF”.

#### (3) AC power button

**DC power on:** Press and hold the AC button for over 2 seconds, the AC indicator will light, and the LCD will display “AC ON”.

**DC power off :** Press and hold the AC button for over 2 seconds, the AC indicator will

be off, and the LCD will display “AC OFF”.

 **Note:** Turn off these buttons to save power when no using.

 **Note:** The LCD background light will automatically go off after no operation for a period of time, and will be on again when short pressing any button.

 **Note:** If the DC/AC button is turned off and there is no other operation, it will shut down automatically after 10 minutes to save power.

## ●Connectible devices

**USB output port:** smartphone, MP3 player, digital camera, electronic reader, tablet computer, etc.

**Type-C PD output port:** smart phones, tablets, etc.

**DC 12V 5521 output port:** mainly used for LED light bulb lighting.

**DC12V Cigarette Lighter output port:** Vehicle Refrigerator and Other 12V equipment.

**AC output port:** notebook computer, camera, display devices and other AC power supply working equipment.

 **Note:** DC output is suitable for most products in the market. Some products with instantaneous high current may trigger over-current protection.

 **Note:** Please make sure that the connected electrical products can work properly before using this product.

 **Note:** AC output uses electrical products with power below 300W.

 **Note:** According to different electrical products, rated power below 300W may not be used (air conditioning, motor and other equipment requiring instantaneous high current).

 **Note:** The output will stop automatically after overload protection.

 **Note:** If the output stops repeatedly, please stop using it immediately. Only by eliminating the problem can it be used. Please contact the local designated system installation and maintenance personnel.

 **Note:** Noise may occur in the broadcast or video player or TV and etc which are connected to this product.

## •Estimation of backup time

25smartphones 2 hours 10Watt load	20W LED lamp 25 hours 20Watt load	75W LCD TV 6.6 hours 75Watt load
80W electric tool 6 hours 80Watt load	90W refrigerator 5.5 hours 90W load	200W electric stewing pot 2.5 hours. 200Watt load

$$500Wh \div \boxed{\text{load power consumption(W)}} = \boxed{\text{h(approx.)}}$$

⚠ **Note:** The above data are for reference only. The backup time varies with the power of different loads.

## 5. Storage and maintenance

1. Full charge the machine before storage.
2. Switch off all power buttons.
3. If there is any dirt, soak and wring out the cloth to wipe it clean.
4. Please do not use gasoline, volatile oil, thinner, kerosene, etc. which have the function of dissolving the resin.
5. Keep it in dry and less dusty place. Temperature within 0 - 40°C , avoid direct sunlight.
6. Please full charge the product at least once every six months.

⚠ **Note:** Please do not keep it in the car, trunk, loading platform or other hot place under direct sunlight. It may cause the product failure, degradation or thermal problem.

## 6. Technical specification

Output			
AC output	Rated voltage	100-120Vac	220-240Vac
	Rated power	300W	
	Peak power	450W	
	Overload capability	300W≤load<450W@120S; 450W≤load@1s;	
	Frequency	50/60Hz(adjustable)	
DC12V output (cigarette lighter)	Rated voltage	12Vdc(12-14V Workable)	
	Rated current	10A	
DC12V output (5521)	Rated voltage	9.6-12.6Vdc ①	
	Rated current	3A	
USB output	QC	BC1.2,Apple,Samsung	
	Rated voltage	5V	
	Rated current	3A	
Type-C output	QC	PD2.0 (45W)	
	Rated output	5V3A, 9V3A ,12V3A ,15V3A , 20V2.25A	
Wireless charge	Qi 1.2.4	Most devices	
	Output power	5W/7.5W/10W	
LED lighting	While the power button is on, press the LED light button in turn, the order of LED light will be: full brightness--half brightness—SOS--turn off		
Input ②			
Input voltage	12-40 Vdc		
Input power	120W MAX		
Battery			
Rated capacity	500Wh		
Rated voltage	11.1 Vdc		
Battery cell type	Li-ion		
Voltage range	9.6-12.6Vdc		
General			
Protection level	IP21		
Working environment condition	Relative humidity: 10%-90%		
	Temperature: 0-40°C		
Size	259.5*191*196mm		
Net weight	6.2 kgs		

### ⚠ **Note:**

- ① it may cause input low-voltage protection of some equipment if the voltage is low.
- ② Solar panel charge type: MPPT

## 7. Trouble shooting

If the product cannot charge or power other devices, please check according to following steps:

1. Make sure the power button is turned on.
2. Make sure the AC and DC power buttons are on, viz. the LED on the right of the button is green
3. Check the battery capacity, if it's lower than 10%, please recharge the product as soon as possible.
4. Make sure the load power connected didn't exceed the limit power of this product, each port has a limit for the power connected

If you can't clear the trouble after above steps, please contact our after sale service center.

Error code	Cause	Protection Condition	Recovery condition
E01	Over Temperature Protection	Heat sink Temp $\geq$ 75°C	Auto Recover when the temp $\leq$ 70°C
E02	Low temperature protection	<-8°C	> -2°C ,self-recovery
E04	Battery Over temperature	>68°C	<58°C ,self-recovery
E05	Battery low temperature	< -8°C	>-2 °C ,self-recovery
E06	Battery charge over temperature	>48°C	<38°C ,self-recovery
E07	Battery charge low temperature	<0°C	>5°C ,self-recovery
E09	Total voltage too low	<9.6V	>10.5°C recover charging.
E18	PV input over voltage	>45V	<40V self-recovery
E25	DC 12V output over voltage	Battery voltage >13V	Recover by pressing button
E26	DC12V-1 output over loaded	Load power >140W	Recover by pressing button
E27	DC12V-1 output over current	output current >11A or short-circuit	Recover by pressing button
E28	DC12V-1 input over current	Current >-1A	Recover by pressing button
E29	DC12V-2 output over loaded	Load power >75W	Recover by pressing button
E30	DC12V-2 output over current	Output current > 6A or short-circuit	Recover by pressing button

E31	DC12V-2 input over current	Current >-1A	Recover by pressing button
E34	System overloaded, DC output stop	Total power>420W at 3mins	Recover by pressing button
E36	Inverter output overloaed	Power>300W at 2mins or power >450W	Recover by pressing button
E37	Inverter output overcurrent	AC output short-circuit	Recover by pressing button
E38	System overloaded, AC output stop	Total power>420W at 3mins	Recover by pressing button

⚠ **Note:** the battery core protection level is high, low temperature protection is priority error code E05.

## 8. Frequently Asked Questions and Answers(FAQ)

### ●How to check the state of charge?

The battery icon display on the LCD display shows the battery level and charge status.

### ●How to use the product to charge other electronic devices?

(1) Check the user manual or search for such information online to learn about the charging parameters of the electronic devices.

(2) Check the power of each output port. For example, the maximum rated output power of the AC output port is 300W, This means that if the power of the connected electronic device exceeds 300W for a long time, the inverter will turn off the output.

### ●What is the depth of discharge (DOD)?

To prolong the battery life, the product has a DOD setting to 90%, which means that only 90% of the battery capacity can be discharged, and retain 10% to avoid damage to the battery due to excessive discharge.

### ●Can it charge and discharge simultaneously?

Yes, but it is not recommended to charge and discharge at the same time in order to protect the battery life.

### ●Can it be charged by using 2 solar panels in series?

Yes, just make sure the total open circuit voltage (VOC) of the solar panels are less than 40V, Otherwise it may trigger the charging overvoltage protection or cause damage.

### ●How to extend the using time of CPAP ?

Recommend to turn off its humidifier, heater, and set a lower pressure.

### ●50Hz/60Hz frequency switching (factory setting: 60 Hz).

**Step 1:** Press the power button to turn the product on, then press the DC and AC button at the same time. The LCD will illuminate and display the current frequency (50Hz or 60Hz). Release the button and continue to the next step.

**Step 2:** Press and hold the DC button or AC button to select 50Hz and 60Hz. The frequency displayed on the LCD will change accordingly.

**Step 3:** After selecting the desired frequency, press the DC button and AC button at the same time to complete the setting. enable after restart, Step 1 can be repeated to check the current frequency.

**•Can the AC output carry a refrigerator or air conditioner?**

Workable for low power, and over 100W is not recommended. The starting power of refrigerators and air conditioners are generally 5~7 times more than the rated power, which easily triggers AC overload.

**•Can two power stations be used in parallel?**

No.