

# DM07 Display

## Functionality Introduction

Product Name: Colored IPS Screen Display

Product Model: DM 07



## **Declaration**

**DM07 functional definition is a function definition description of the standard-version DM07 display produced by Velofox , and is part of the technical documentation.**

**All of Velofox's display products are customized according to the electric system's requirements. While this document is a reference for complete function definitions, operation instructions, and error codes, any configuration difference between your display and the standard DM07 is possible, due to various technical requirements in different ebike applications. Please consult your drive system supplier for additional function requirements and data display.**

---

Content

A Product Introduction.....	5
<b>1.Product name and model.....</b>	<b>5</b>
<b>2. Product introduction.....</b>	<b>5</b>
<b>3. Range of application .....</b>	<b>5</b>
<b>4. Appearance and size .....</b>	<b>5</b>
<b>5. Display coding rules.....</b>	<b>6</b>
B. Product manual.....	7
<b>1. Specifications .....</b>	<b>7</b>
<b>2. Function overview .....</b>	<b>7</b>
<b>3. Installation .....</b>	<b>8</b>
<b>4 .Interface .....</b>	<b>8</b>
4.1 Boot interface.....	8
4.2 Basic interface and operation.....	9
4.3 Function interface introduction.....	10
Boot interface and basic function interface .....	10
Other function interfaces.....	10
Setting interface .....	13
<b>5. Button definition .....</b>	<b>14</b>
5.1 Button name .....	14
5.2 Definition of button operation .....	15
<b>6. Basic function operation.....</b>	<b>15</b>
6.1 Turn on/off the display.....	15
6.2 Assist level switch.....	15
6.3 Information switch .....	16
6.4 Light control function .....	16
6.5 Maintenance reminder .....	17
6.6 Walk assist function .....	17
6.7 Battery power indicator and assist power output.....	18
<b>7. Setting function .....</b>	<b>19</b>
<b>8. Advanced setting functions.....</b>	<b>22</b>
*Warning.....	22
Advanced setting operation instructions .....	22
<b>9. Data clearance .....</b>	<b>25</b>
<b>10. Error information .....</b>	<b>25</b>
<b>11. Wire definition .....</b>	<b>27</b>
11.1 Standard wires definition: .....	27
C Package specifications.....	28
D Note.....	29

---

## A Product Introduction

### 1. Product name and model

IPS display of electric power assist bikes

Product model: DM07

- DM07 includes two versions of UART communication and CAN BUS communication  
DM07\_U corresponds to UART communication version;  
DM07\_C corresponds to CAN BUS communication version.
- All DM07 products are available to add Bluetooth function in its hardware.

### 2. Product introduction

- ✧ Tempered glass screen with beveled edge
- ✧ 2.0 inch HD high brightness full viewing angles IPS LCD display
- ✧ Special screen fitting technology, great sunlight and outdoor readability
- ✧ Independent operating buttons with ergonomic design
- ✧ IP65 waterproof level, excellent for outdoor use
- ✧ Built-in Bluetooth function, compatible with CAN-BUS and UART communication
- ✧ Service Tool function for fast firmware upgrade, parameter setting, and easy maintenance

### 3. Range of application

Suitable for all E-bikes that comply with EN15194 standard

### 4. Appearance and size

The shell material of DM07 is PC+ABS, the screen is made of imported tempered glass with beveled edge. This product is suitable to be installed on a horizontal handlebar tube size of  $\phi$  22.2mm.



## 5. Display coding rules



DM03-C01M120140001

V01. XXX. XX-24V2526XX

As shown in above picture:

DM03-C01M120140001

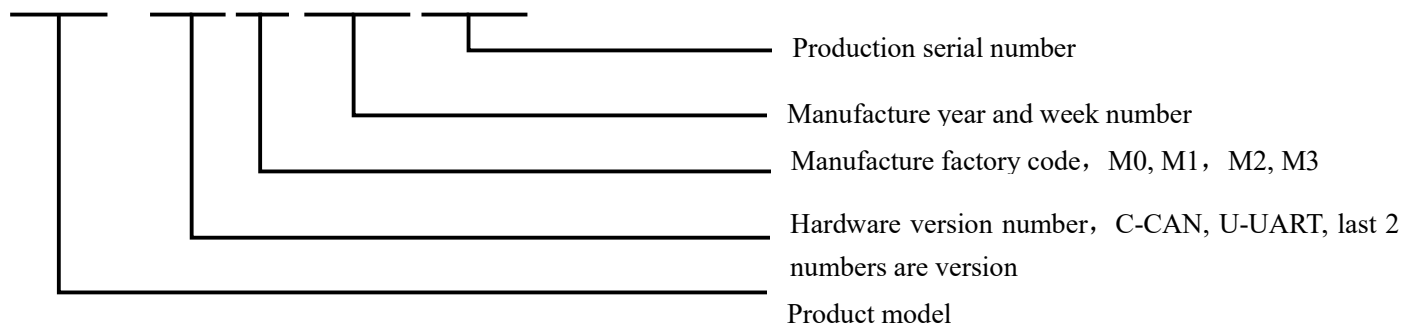

A08.01-36V2570XX

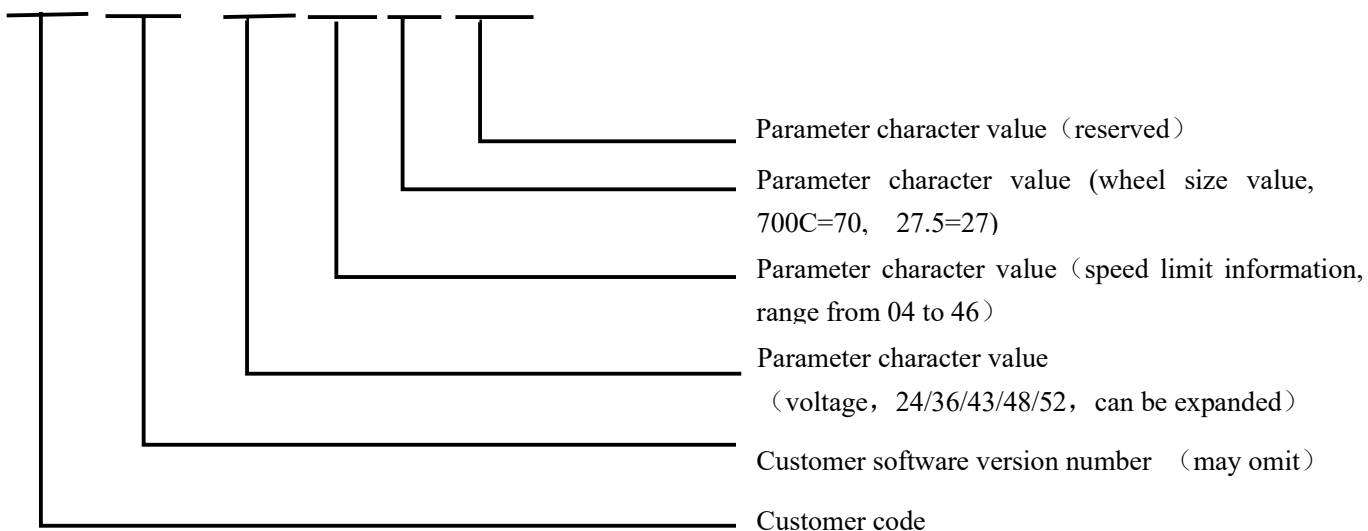

---

## B. Product manual

### 1. Specifications

- ① Power supply: DC 24V/36V/48V
- ② Rated current: 23 mA
- ③ Shutdown leakage current: <1uA
- ④ Screen specification: 2.0 inch IPS LCD display, resolution 320\*480
- ⑤ Communication method: UART/ CAN-BUS
- ⑥ Operating temperature: -20° C ~ 60° C
- ⑦ Storage temperature: -30° C ~ 80° C
- ⑧ Waterproof level: IP65

### 2. Function overview

- ① Left side independent buttons with ergonomic design
- ② Customization of boot interface and UI
- ③ Unit: Km/Miles, Language: English/German
- ④ Display key riding data, speed, mileage, battery info, etc.
- ⑤ Statistical function for power assist mode
- ⑥ Walk assist function
- ⑦ Auto headlight on/off function
- ⑧ Error code indication
- ⑨ Real-Time Clock for a current time indication
- ⑩ Range and battery indication (\*available if BMS provides necessary info)
- ⑪ Percentage Analysis of total power output shared between engine and rider (\*available if torque sensor provides necessary info)
- ⑫ Health info statistics (\*available if connected to external bluetooth device)
- ⑬ Include Bluetooth hardware, for wireless connection to a smartphone to achieve GPS function
- ⑭ Maintenance service reminder and setting

---

⑮ Parameters setting and advanced setting

### 3. Installation

① Open the display lock clip, set the display in the left handlebar (standard handlebar size:Φ22.2).Adjust to a position easy to operate tighten and fix the screw by M3 hexagon. Tightening torque: 0.8N.m.

**\*Note: Damage caused by excessive torque is not covered by the warranty.**

② display connected with controller by 5 pin connector as required drawings.

### 4 .Interface

#### 4.1 Boot interface

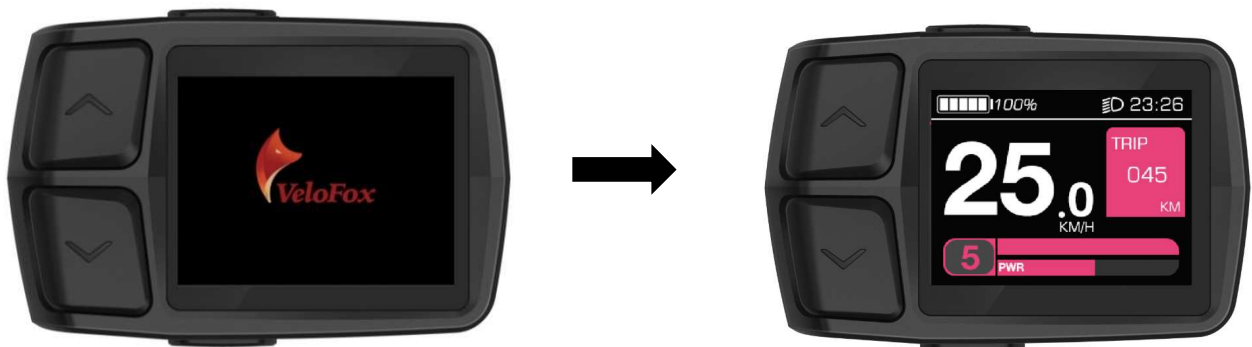

Boot logo interface is displayed for 3 seconds after the display is turned on. When the communication connection is established, display enters the main interface which shows information obtained from the controller. ( All data displayed is following communication protocol provided by the customer)

**\* Animated boot interface available for customization**

---

## 4.2 Basic interface and operation



- ① 4 buttons : the power button、 M button、  $\wedge$ 、  $\vee$  Adjustment button。
- ② The standard outlet method is waterproof connectors, which can be selected according to customer orders.
- ③ The screen of the DM07 adopts a 2.0-inch high-brightness and high-definition IPS LCD screen, which meets the customization and modification requirements of the boot interface and local UI interface.



### 4.3 Function interface introduction

#### Boot interface and basic function interface

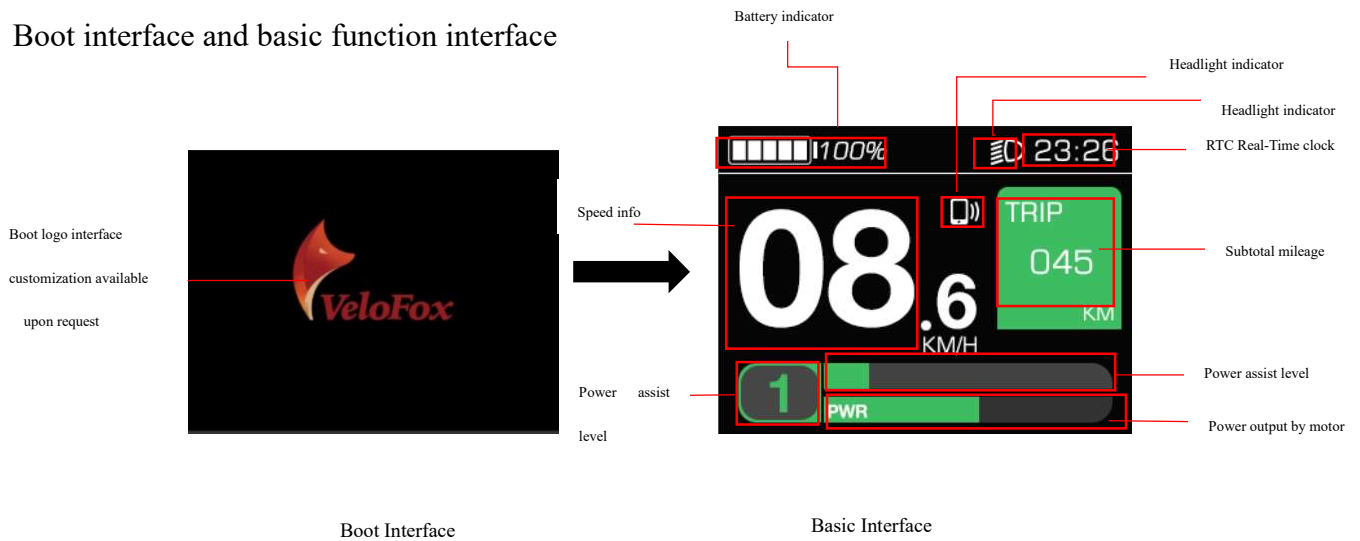

Boot logo interface is displayed for 3 seconds after display is turned on. When the communication connection is established, display enters the main interface, showing real-time information stored in the controller and battery BMS according to the communication protocol. (Battery indicator will not show battery percentage if BMS info is not available)

#### Other function interfaces

##### Function interface I

Function interface I mainly display speed information, including average speed, maximum speed, and TRIP info which is subtotal mileages as shown on basic interface. Speed display value has 3 digits, maximum value is 99.9KM/H, including one digit after the decimal point. Subtotal mileage TRIP value has 4 digits, including one digit after the decimal point. After 9999.9 KM is exceeded, the decimal point is not indicated, and a 5-digit mileage value is displayed directly, with a maximum value of 99999km. After the maximum value is exceeded, the value is shown as the actual mileage value deducted by 100,000.

Data on function interface I can be cleared by a button operation



### Function interface II

The function interface II mainly displays battery information, including voltage, capacity percentage, accumulated charging cycles, and Range which is endurance mileage. Accumulated charging cycles are provided by battery BMS, if it is not available from BMS, display shows ---- for charging cycles. The Range is calculated by controller using battery BMS capacity info, if controller can not provide range info, range info shows----.

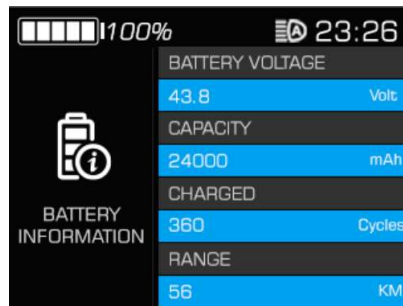

### Function interface III

The function interface II mainly displays motor information, which requires controller's support.

The power analysis area displays power statistics, including average power output by motor, the maximum output by motor, and power output shared between rider and motor. Power output by motor will follow data provided by controller, if requested info is not available from controller, display will calculate using collected voltage and electric currents data.

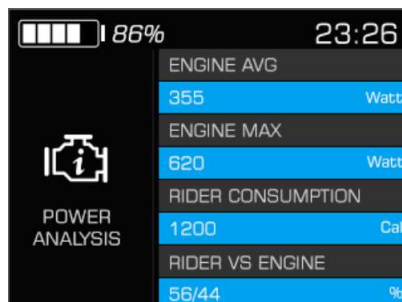

---

## Function interface IV

The function interface IV mainly displays the usage time statistics of different power assist modes during the riding process. The statistical data is calculated by the meter according to the actual riding state and displayed as percentage data. The statistics of the usage time of the power-assist mode can be reset to zero by pressing the button.

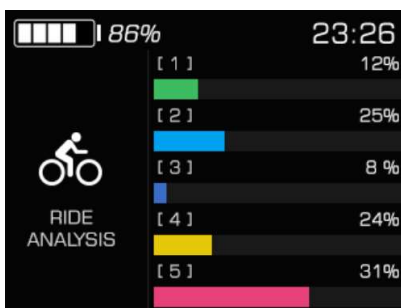

In the state of the basic function interface, short press the M key to switch the display of each function interface. In any function interface, if there is no key operation within 5S, it will jump back to the basic function interface.

## Walk assist interface

Long press  to enter walk assist mode, interface shown as below:



---

## Maintenance reminder interface

The display can be set with regular maintenance reminders, and when reaches the set mileage value, display will notify the user through the maintenance reminders. After the maintenance reminder mileage is reached, display will show a notification interface every time being turned on to prompt the user to carry out daily vehicle maintenance. Notification interface can be cancelled by short press M button manually. After connecting to service tool box, the maintenance reminder can be reset through after-sales diagnostic tool, and meanwhile, the maintenance record will be registered.

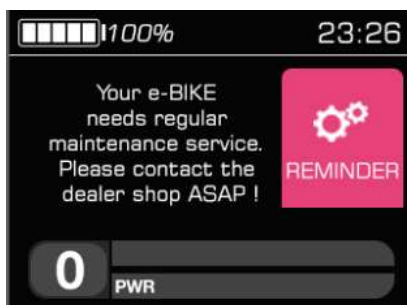

## Error code interface

When the display receives the error info returned by controller, it will show a detailed error code on interface, indicating relevant electrical system fault information. The error code will be displayed numerically in the speed display area.

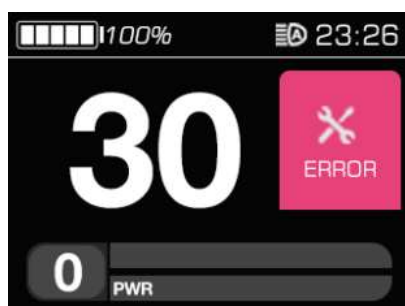

## Setting interface

Within 10s after turning on display, long press M button to enter the setting interface, short press  $\wedge$ 、 $\vee$  to switch between setting interfaces. Short press  $\wedge$ 、 $\vee$  to enter parameter picking state.

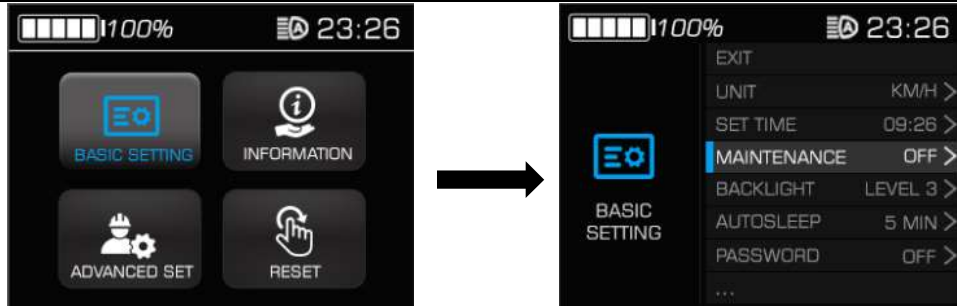

**For more setting operation illustration, please refer to part 7**

## 5. Button definition

### 5.1 Button name

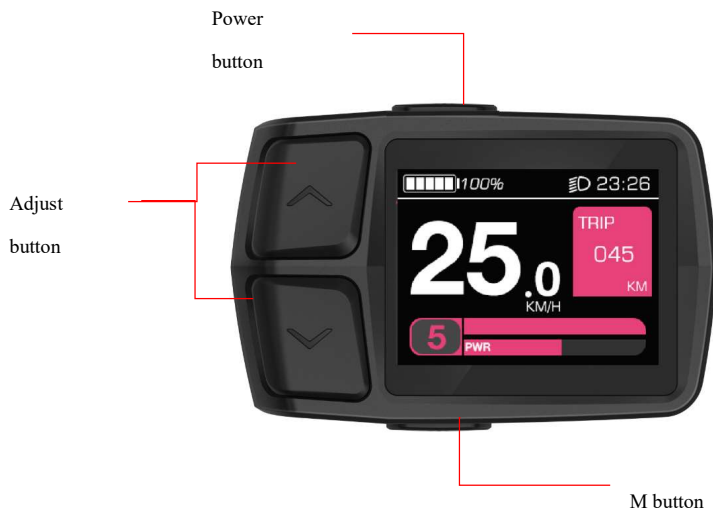

Power button: Turn on/off the display

Adjust button: Adjust the assisting power level during riding and switch functions

Long press the adjust buttons to perform specific function operation



Mode button: Switch interface functions and enter into parameter setting interface

## 5.2 Definition of button operation



Operation Type	Description
<b>Short press</b>	Press the button and soon released, while the button is released, the function activated accordingly
<b>Long press</b>	Press the button and hold, when the hold time exceeds the setting time (generally 2 seconds), the function activated accordingly.

## 6. Basic function operation

### 6.1 Turn on/off the display

To turn on, long press  button until boot logo interface appears and shortly enters the basic interface. To turn off, long press  button until display is turned off. If the rider does not perform any operation on the display within set shutdown time, while speed is 0, and current is less than 1A, then the display will be turned off automatically. Set shutdown time is self-defined by user.



### 6.2 Assist level switch

During normal working state, short press 、 buttons to switch assist level, and change assist mode

Power assist display modes as shown below:

Digital gear: 0-5 levels



Short press 、 button to switch assist level. Switching level is not cycled, that is, after reaching 5<sup>th</sup> level, short press  button to return to off level. It's the same when adjusting up.

### 6.3 Information switch

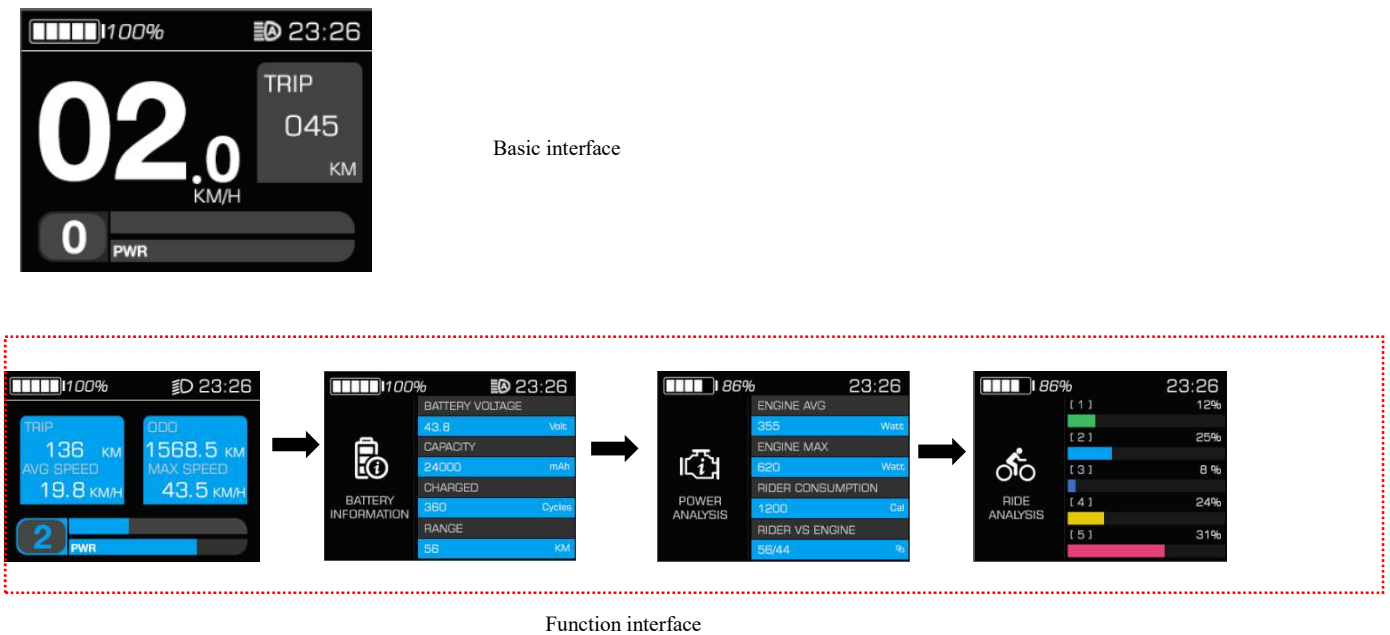

In a power-on state, short press M button to switch alternately from basic interface, function interfaces. In a normal riding state, if the bike speed is greater than 0, and the display is not in the basic interface, then basic interface will be automatically returned to after 5 s no operation on the M button.

The switching process of each interface, as shown below:



### 6.4 Light control function

Display supports automatic lights-on/off function, when loaded with battery and is turned on, the default is to automatically turn on/off lights, that is the display automatically detects the ambient light intensity and controls the turning on/off of the lights. The icon  on the top right corner of the basic interface indicates automatic lights-on state.

When automatic lights-on/off function fails, long press  button to manually turn on the front light, a light icon  on top left corner of screen will appear indicating light-on status. Long press  button to manually turn the lights off.

Automatic lights-on/off function is disabled , after manually turn off the headlight. Re-start

---

display to enable automatic lights-on/off function.



When headlights are on, screen brightness will be lowered to preset brightness level.

## 6.5 Maintenance reminder

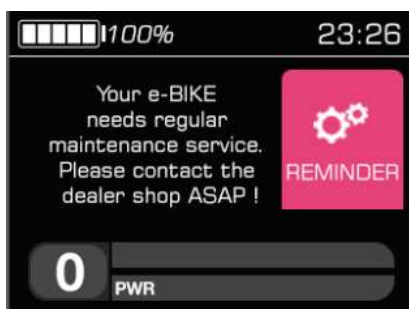
Display supports maintenance reminder function, when this function is enabled, the display will remind the user to give ebike a maintenance check once the total mileage reached a preset value. maintenance reminder function can be turned on/off in the setting interface and is turned on by default. The factory default reminding mileage is 5000km which is not modifiable by users, that is, display will remind the user to give a maintenance check once the total mileage reached 5000km.



## 6.6 Walk assist function

When speed is 0, long press  button to enter walk assist mode, motor outputs power according to the set speed and control the actual walk speed, display shows the walk assist icon  and the real-time speed. Release  button or any other button to exit walk assist mode, the motor is turned off, and the display gets back to the basic interface. Walk assist interface, shown as below:





## 6.7 Battery power indicator and assist power output







Battery power information is divided into battery bar indication and remaining percentage indication. When battery power is normal, battery capacity is divided into 5 bars. Before communication is established, the battery percentage is not displayed, and the power bar is full and blinks at 2Hz. After battery info is acquired, power bar will stop blinking, and displays the power percentage. If communication is not successful within 3s, it will stop blinking and no power percentage will be displayed.

After battery capacity is lower than 5% or the voltage is lower than low voltage value, display will enter the low-voltage mode. In this mode battery level showed level 0 and border blink at 1Hz, with no power output from the motor, and disabled assist level switch. Power assist level is displayed as OFF or 0.

To get out of low-voltage mode, reset, and increase the voltage above low-voltage value and battery capacity above 5%.

Percentage of battery power (C) and power level table

(Battery % info is required from BMS or controller) :

SOC	Battery level	Description
$80\% \leq \text{SOC}$		Full battery level 5
$60\% \leq \text{SOC} < 80\%$		Level 4
$40\% \leq \text{SOC} < 60\%$		Level 3
$20\% \leq \text{SOC} < 40\%$		Level 2
$10\% \leq \text{SOC} < 20\%$		Level 1
$5\% \leq \text{SOC} < 10\%$		Level 0
$0\% \leq \text{SOC} < 5\%$		Level 0 and icon blink at 1Hz





- 
- Remarks about battery indicator:

When there is a battery communication error:

1. Display will estimate the power according to the voltage and show the battery level accordingly;
2. No battery percentage information will be shown;
3. Range information will not be displayed;
4. If the voltage is lower than the low-voltage value, the effect of the current on voltage needs to be considered when converting to a voltage at 0 current

## 7. Setting function

Display provides specific parameter setting functions. The optional items of setting function will be deleted according to different market and product standards. The following is the complete parameter setting, information reading function description under the default state of display. Please contact our sales and technical support team for confirmation in case of any discrepancies.



Within 10s after turning on display, long press M button to enter setting interface, short press ,  button to switch between setting interfaces. In any setting interfaces, short press M button to enter parameter editing state, the blue mark indicates chosen parameter, and selected option or value will be indicated by a white font with a grey background. Short press ,  button to edit parameters. Long press M button to confirm parameter selection. Long press M button again to exit and return to previous page





Selected option or value will be indicated by a white font with grey background, as shown below:

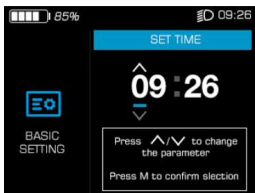
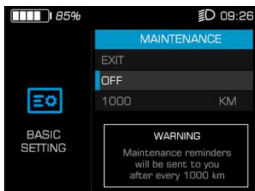

In any setting interfaces, short press M button to enter the next level menu, and long press M button to return to the previous level menu.

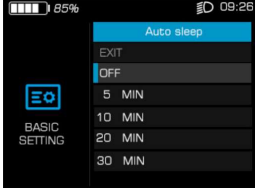
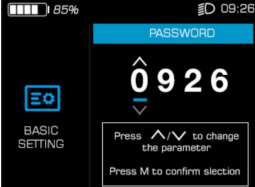
First level parameter setting interface, and the description of each parameter interface is as follow:

Setting items	Interface	Description	Setting data	Remark
Unit setting		UNIT	Value=KM/H MPH	Default Value=KM/H  KM/H—Metric MPH — Imperial
Clock setting		SET TIME	Customization	Default= 12: 00
Maintenance reminder		MAINTENANCE	Fixed value	Default= 5000km
Backlight level setting		BACK LIGHT	Value= LEVEL1,backlight level 60% Value= LEVEL 2 backlight level 80% Value= LEVEL 3 backlight level 100%	Default Value= LEVEL 3

Auto shutdown time		Auto sleep	Value=OFF,5-30 min	Default Value=5min OFF means no auto shutdown
Power on Password setting		Password	Value= OFF and ON; When is ON, user is allowed to set 4-digit password	Default value: OFF
Display info		Display information	read only	According to communication protocol
Battery info		Battery information	read only	According to communication protocol
Controller info		Controller information	read only	According to communication protocol

---

## 8. Advanced setting functions

### \*Warning

The advanced setting function is based on specific protocol content, allowing to modify and set the controller and system parameter through display side. This feature is only available to specific groups of people, such as bike manufacturers, dealers and other entities with professional technical capabilities. Debugging and maintenance are allowed through advanced setting functions. In case of improper parameter setting or other setting problems, the whole system will work improperly or even have failure problems. **Please be cautious about whom to open this feature to.**

Advanced settings require a specific password, if you need to use this feature, please communicate with our company sales and technical support team to confirm compatibility with your current hardware version. In the meantime, please confirm with our sales and technical support team for adequate maintenance capacity, before obtaining the password.

### Advanced setting operation instructions

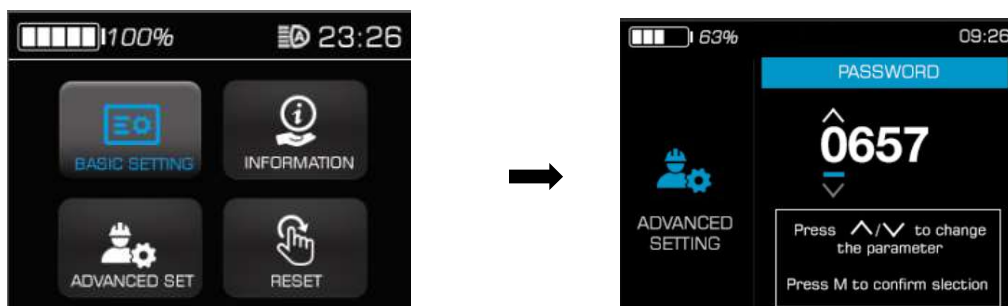

After selecting the advanced setting in the first-level menu, short press M button to enter the login password. Short press M button to select the corresponding password digit in the 4-digit password field. The selected password digits will be highlighted with a white background. Short press  $\wedge$ 、 $\vee$  to edit password value, and short press M button again to confirm the input. The password input interface is as follows:



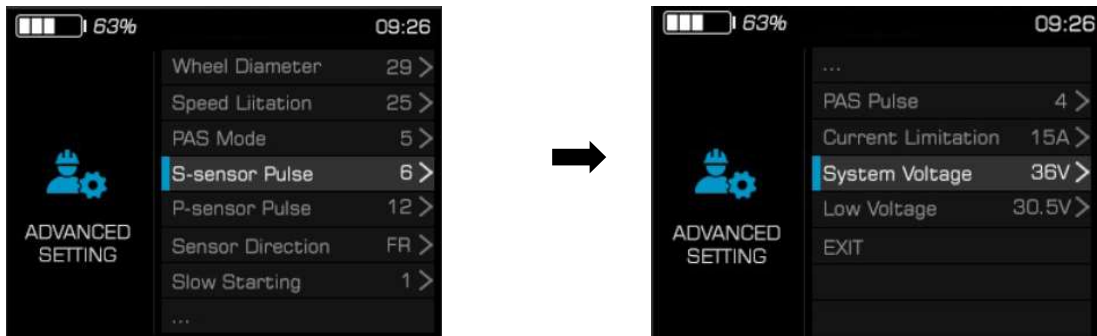



After the password is typed correctly, advanced setting is entered, divided into two-page contents. Short press  $\wedge$ 、 $\vee$  to pick and select.

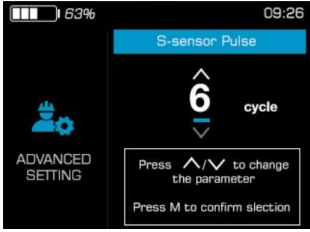

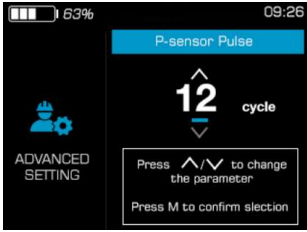
Advanced setting functions descriptions:

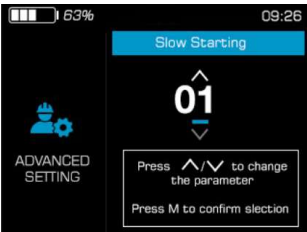
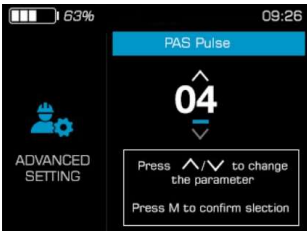
Setting item	Interface	Description	Setting data	Remark
Wheel size setting		WheelDI=Wheel diameter	Value=12, 14, 16, 20, 24, 26, 27, 27.5, 700C, 28, *29, *CCF ( *Value is optional )	Default value: 26
Speed limitation setting		SpdLtd=Speed limitation	Value= 5 to 46	Default Value= 25 Step=1
Power assist display setting		PAS=Pedal assistant Mode	Value= Dig-3; Dig-5; ICON	Dig-3: Digital 3 gear levels Dig-5: Digital 5 gear levels ICON: Eng version gears
Power assist level setting`		Ssensor=Speed sensor	Value= 1--12	L1-L5 Power assist level corresponding to each gear Step=1%

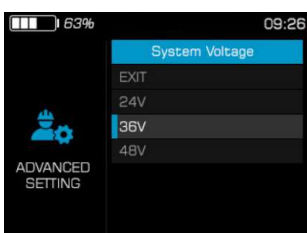
Speed sensor magnet numbers		P-Sensor=PAS sensor	Value= 1-64	Default value: 1 Step=1; magnets detected by motor
Power assist magnet number		Direc=PAS sensor direction	Value= F or R	Default value: 12 Step=1; Power assist magnet number
Power Assist Magnet direction		Slow-ACC= slow acceleration	Value= 0-3	F=Forward R=Reversed Signal direction of sensor, can be adjusted corresponding to right or left instalation
Slow acceleration		P-Pulse=assistance started pulse	Value= 2-63	Default value: 0
Number of poles for power assist magnet		CurLtd=current limitation	Value= 0-31.5A	Default value: 2 Step=1 Number of starting magnets
Current limit setting		SysVol=select system voltage	Value= 24V/36V/48V	Default Value: 12 Step=0.5A Controller's current limit setting

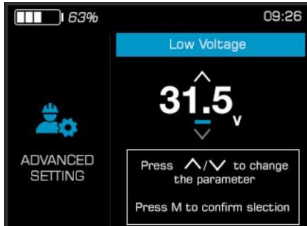
System voltage setting		LowVol=low voltage level	Value= 10.0-52.0V	Default value: 36V Choose system voltage
------------------------	---	--------------------------	-------------------	---

## 9. Data clearance

Data clearance is aimed at the removal of data information such as subtotal mileage TRIP, average speed, and maximum speed. 10s after display is turned on when display is at function interface, long press M button to show data clearance window, and short press ^、v button to select accordingly. To remove the pop-up clearance window, long press M button or remain no operation for 30s.



After clearance, the subtotal mileage TRIP is 0, average speed, and max speed is 0. ODO information can't be cleaned manually on the display, professional service tools are required.

## 10. Error information

Display can warn bike faults. When faults are detected, error code will be shown on the interface and blink at 1Hz. When error code is shown, button functions will not be affected, meaning interfaces can be shown normally by pressing buttons. If no button operation after 5s, the display will return to the error code interface.

Error code interface as shown below:





Bafang protocol's error code information table:

Error code	Error description	Suggest operation
"04" shown at speed	throttle doesn't turn back to zero position (stay on the high position)	Check if the throttle turned back
"05" shown at speed	throttle failure	Check throttle
"07" shown at speed	overvoltage protection	Check battery voltage
"08" shown at speed	failure of motor's hall signal wire	Check motor
"09" shown at speed	failure of motor's phase wire	Check motor
"11" shown at speed	failure of the motor's temperature sensor	Check controller
"12" shown at speed	failure of the current sensor	Check controller
"13" shown at speed	failure of the temperature of the battery	Check battery
"14" shown at speed	Controller temperature is too high, and reaches the protection point	Check motor
"21" shown at speed	failure of the speed sensor	Check the install position of the speed sensor
"22" shown at speed	Failure of BMS communication	Change battery
"30" shown at speed	communication failure	Check connector to controller

(\* Different communication protocols are different in error code system. If an error code appears, please communicate with our sales and technical support team to verify and confirm!)

## 11. Wire definition

### 11.1 Standard wires definition:

The standard outlet of the display is defined by Velofox according to the conventional application, and the standard outlet needs to match the corresponding conversion harness. Our company has corresponding standard settings for the conversion line length and interface standards. If the standard settings cannot meet your requirement, a customized conversion harness is required.

Standard outlet in a sample is shown in the figure below:

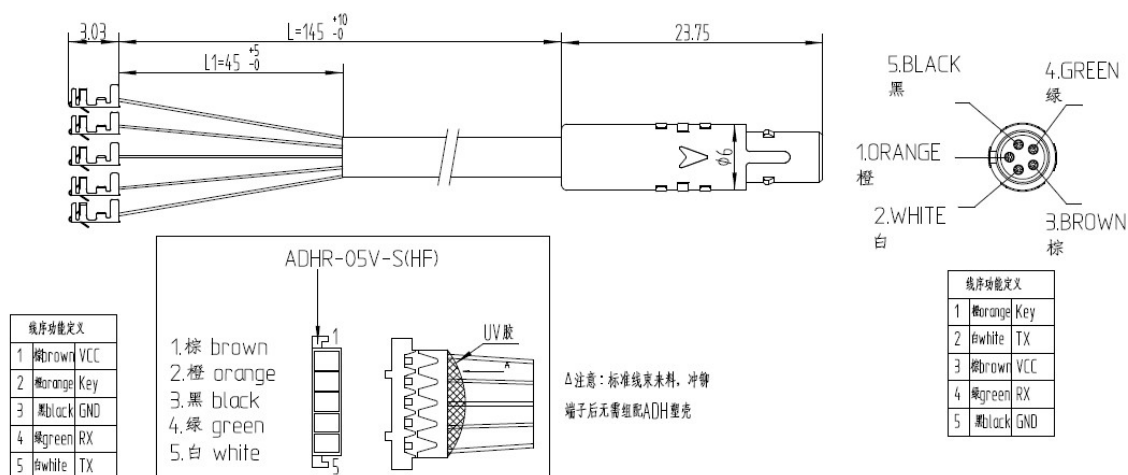
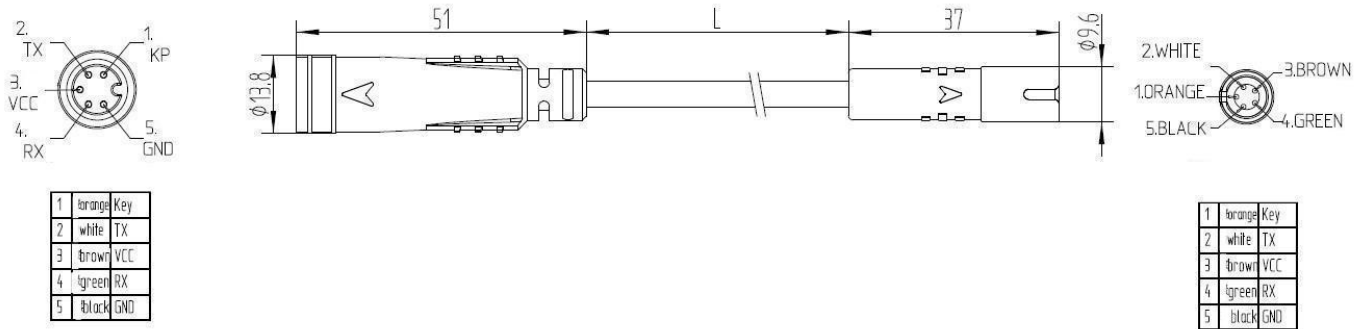

Table 1 Standard wire definition

No.	Color	Function
1	Orange(KP)	Power lock control wire
2	White(TX)	Data transmission wire of display
3	Brown(VCC)	Power wire of display
4	Green(RX)	Data receiving wire of display
5	Black(GND)	GND of display
6	reserve	reserve

## 11.2 Standard conversion wire specifications:

### Adaptor-C2H:



### Adaptor-C2J:

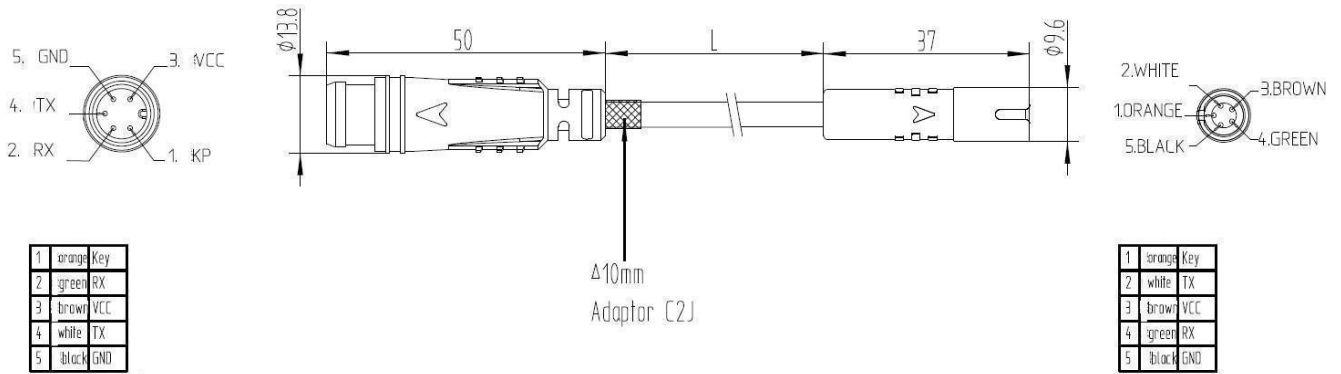

## C Package specifications

Standard delivery, in double corrugated box packaging. The inner layer is a double corrugated septum plus EPE foam product bag.

Outer box size: 580\*390\*168mm (L\*W\*H)

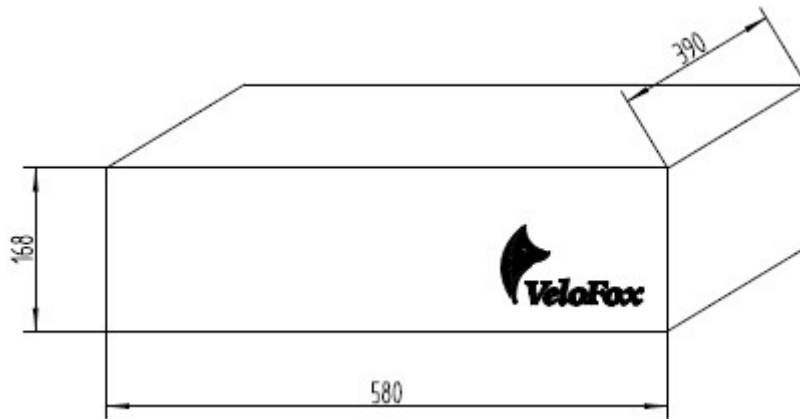

## D Note

- ✧ In the use of the display, pay attention to the security, do not plug the display in and out when the power is on;
- ✧ Try to avoid exposure in harsh environments like heavy rain, heavy snow, and strong sunlight
- ✧ When the display can't be used normally, it should be sent to repair as soon as possible