



Solar system

PLANETARY E PROJECTOR MANUAL

0
Level

 LIFE
SCIENCES

 PHYSICAL
SCIENCES

 GEO-
SCIENCES

 SPACE &
TECHNOLOGY



3+
Year

STEAM
EDUCATIONAL PRODUCT



WARNING CHOKING HAZARD-SMALL PARTS. NOT FOR CHILDREN UNDER 3 YEARS.

产品配件 Parts List

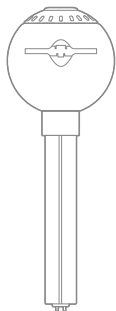

投影球 x1
Projection Balls x1



投影片 x3
Slides x3

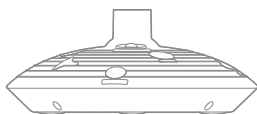

底座 x1
Pedestal x1



水星支架 x1
Mercury Stand x1

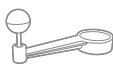

金星支架 x1
Venus Stand x1

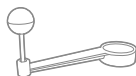

地球支架 x1
Earth Stand x1



火星支架 x1
Mars Stand x1



木星支架 x1
Jupiter Stand x1



土星支架 x1
Saturn Stand x1



天王星支架 x1
Uranus Stand x1



海王星支架 x1
Neptune Stand x1

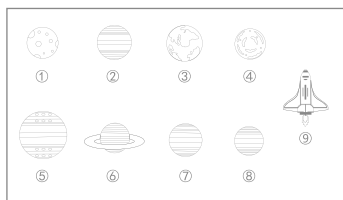

星球贴纸 x1
Planets Sticker x1

安装说明 Assembly

星体贴纸指示：

Planets sticker instructions:



①  水星 Mercury

⑥  土星 Saturn

②  金星 Venus

⑦  天王星 Uranus

③  地球 Earth

⑧  海王星 Neptune

④  火星 Mars

⑨  航天飞机 Space Shuttle

⑤  木星 Jupiter

1. 将卡槽插入底座并扣紧
1. Insert the card slot into the base and fasten

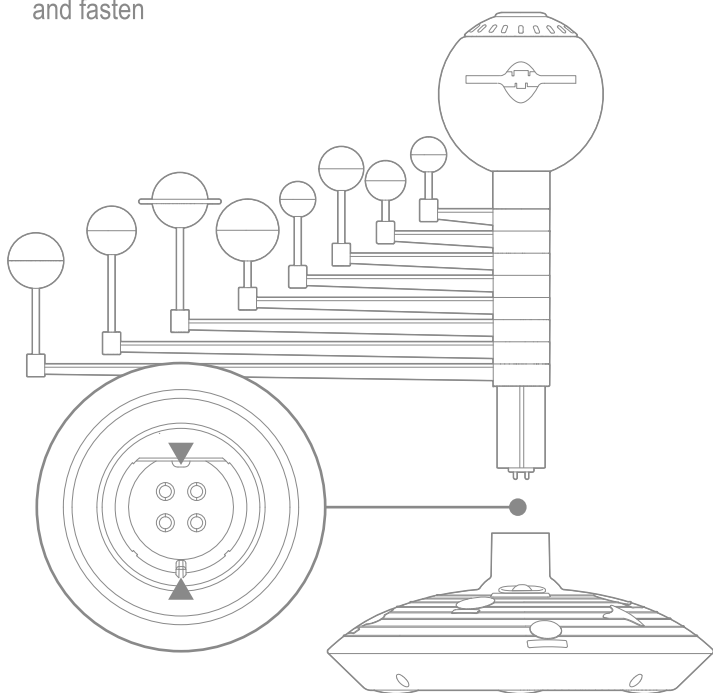

2. 插入投影片并打开开关
2. Insert the slide and turn on the switch

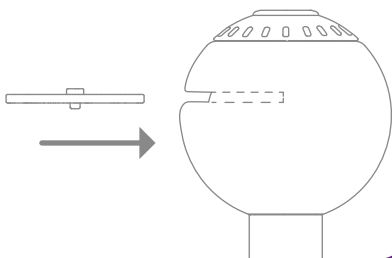

保养和维护：

- 1、用柔软的干布轻擦主机外部，保持机身清洁。
- 2、避免阳光直射，远离任何热源。
- 3、当长期不用时，请将电池取出。
- 4、不可与硬物相碰撞，或试图拆卸主机。
- 5、不可把主机浸在水中，并避免受潮。

常见故障排除：

如果因某些原因而使主机停止响应，请遵循如下操作：

- 1、关闭主机；
- 2、取出电池，中断电源；
- 3、将主机放置数分钟，再重新装入电池；
- 4、重新开机，此时再进行使用。
- 5、如主机仍不能工作，请装入新的电池。

MAINTENANCE:

- 1.Wipe the outside of the main machine with a soft dry cloth to keep the machine clean.
- 2.Avoid direct sunlight and keep away from any heat sources.
- 3.Remove the battery, When not in use for a long time
- 4.Avoid confiding with hard objects and disassembling.
- 5.Do not immerse the main machine in the water and avoid damp.

COMMON TROUBLE SHOOTING:

If for any reason the host stops responding, please follow these steps:

1. Close the host.
2. Remove the battery to interrupt the power supply.
3. Place the machine for several minutes and then reload the battery.
4. Reboot then use it.
5. If the machine is still not working, please install new batteries.

产品介绍：

此玩具是结合投影与语音的多功能太阳系科普玩具，通过语音与投影功能介绍太阳系相关知识，增加儿童对八大行星知识的学习。培养儿童对天文科学的兴趣，在探索中学习，学习中成长。

警告：

所有包装物料，如胶带、塑胶片、捆绑线、标签等，都不属于产品的一部分，不适于儿童玩耍，为了您孩子的安全，请妥善处理以上包装物料。用户手册含有重要信息，请保留备用。

电池安装：

- 1、确认机器处于关闭状态。
- 2、用螺丝起子将机器底部的电池盒盖拧开。
- 3、主体按照右图一所示以正确极性 (+, -) 装入 3 节新 1.5V AA (LR6/5 号) 电池。
- 4、放上电池盒盖并拧紧螺丝。

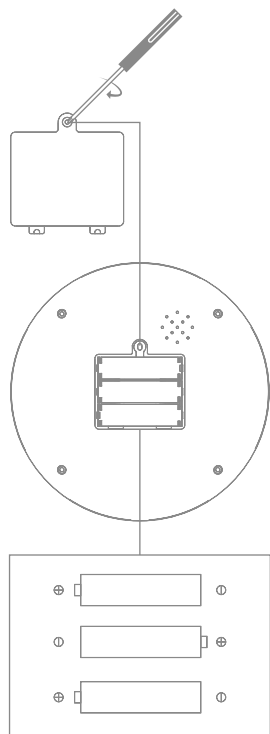

图一

PRODUCT INTRODUCTION:

This toy is a multi-functional solar system science popularization toy which combines projection and speech. It introduces the solar system related knowledge through speech and projection function, and increases children's learning of the knowledge of the eight planets. Cultivate children's interest in astronomical science, learn and grow in exploration.

WARNING:

All packaging materials, such as tapes, plastic sheets, binding wires and labels, are not part of the product and are not suitable for children to play with.

For the safety of your child, please handle packaging materials properly. The user manual contains important information, please keep it for later use.

BATTERY INSTALLATION:

1. Confirm that the game is fully closed.
2. Unscrew the cover of the battery box at the bottom of the toy with a screwdriver.
3. Put three new 1.5V AA (LR6/5) batteries into the main body in the correct electrode(+ , -) as shown in the Figure 1 on the right.
4. Put on the cover and tighten the screws.

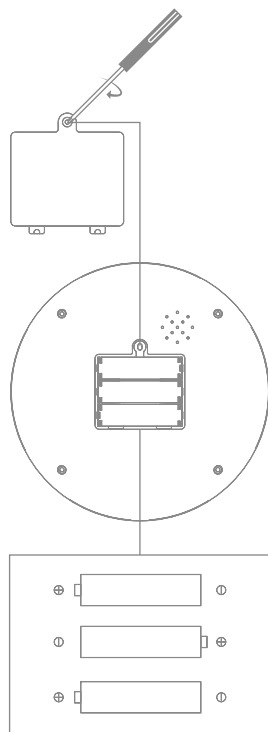

Figure 1

电池使用注意事项：

- 1、可以使用碱性、碳锌等类型的电池；
- 2、非充电电池不能充电；
- 3、充电电池只能在成人的监护下充电；
- 4、充电电池在充电前应从玩具中取出；
- 5、不同类型的电池或新旧电池不能混用；
- 6、电池应以正确的极性(+,-)放入；
- 7、用尽的电池应从玩具中取出；
- 8、电源端子不得短路；
- 9、长时间不用时,请取出电池；
- 10、不要将电池投入火中。

NOTE FOR BATTERY USAGE:

1. Alkaline, carbon and zinc batteries can be used.
2. Only rechargeable batteries can be charged.
3. Rechargeable batteries can only be charged under adult supervision.
4. The rechargeable battery should be removed from the toy before charging.
5. Do not use different types of batteries or old and new batteries in mixture.
6. The battery should be put in the correct polarity (+,-).
7. Depleted batteries should be removed from toys.
8. The power terminal shall not be short-circuited.
9. Remove the battery when not in use for a long time.
10. Don't put the batteries on the fire.

使用说明 Instruction

1. 开关键向左或向右滑动, 开启语音模式, 触摸八大星球图标
播放语音双语(中或英文)星球简介

1. Switch the key to the left or right, open the voice mode, touch the eight
planet icons to play the bilingual (Chinese or English) planet introduction



2. 顶部星球可插或替换投影片, 转动投影片播放投影内容;
旋转星球顶部可调节投影清晰度

2. The top planet can insert or replace the slide, turn the slide to play the
projected content;
Rotate the top of the planet to adjust the projection clarity





航天飞机
Space Shuttle



太空漫步
Space Walk



卫星 1 号
Satellite 1



月球漫步
Moon Walk



卫星 2 号
Satellite 2



星球探测车
Planet Probe



火箭发射
Rocket Launching



火星漫游车
Mars Rover



星云 1 号
No.1 Nebula



星云 2 号
No.2 Nebula



星云 3 号
No.3 Nebula



星云 4 号
No.4 Nebula



星云 5 号
No.5 Nebula

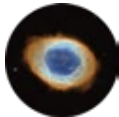

星云 6 号
No.6 Nebula



月亮
The Moon



太阳
The Sun



水星
Mercury



金星
Venus



地球
Earth



火星
Mars



木星
Jupiter



土星
Saturn



天王星
Uranus



海王星
Neptune

3. 转动星球支架以了解每个行星的位置以及与太阳的距离

3. Rotate the planet stand to understand the position of each planet and its distance from the sun

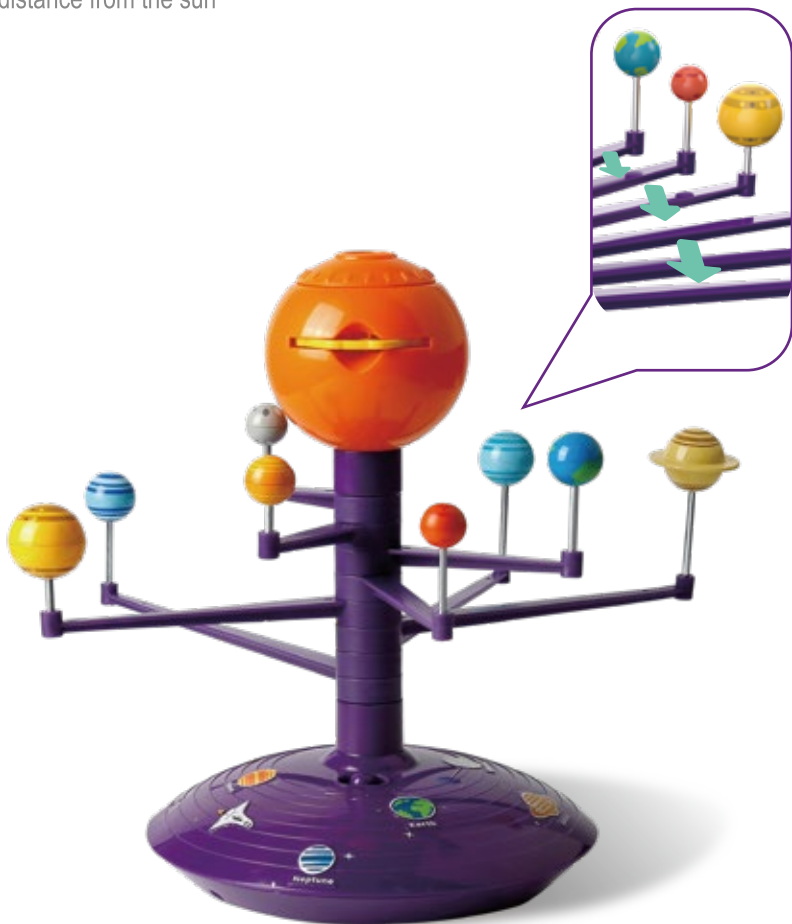

SCIENCE CAN (HIBL) LEARNING

Improve children's scientific thinking
& problem-solving ability



**LIFE
SCIENCES**



**PHYSICAL
SCIENCES**





**GEO-
SCIENCES**



**SPACE &
TECHNOLOGY**



微信  扫码看玩法视频
畅玩攻略, 探索不一样的世界

Wechat  scan code to see the play video
How to play to explore a different world

Item No: 120473

Manufacturer: Jiangsu TopBright Wisdom Information Technology Co.Ltd TEL: +(86)0571-86879391
Address: NO.10, Wenzhou road, Economic-Technological Development Area, Shuyang county, Suqian

TOPBRIGHT ANIMATION CORPORATION
Address: 6/F, The Agriculture building, Anyang district, Ruian, Zhejiang, China

TOPBRIGHT GmbH, Brunnengasse 65, 90402 Nürnberg, Germany
Website: <http://www.topbrighttoys.com>

©2020 TOPBRIGHT ANIMATION all rights reserved. MADE IN CHINA