

# Portable Power Station

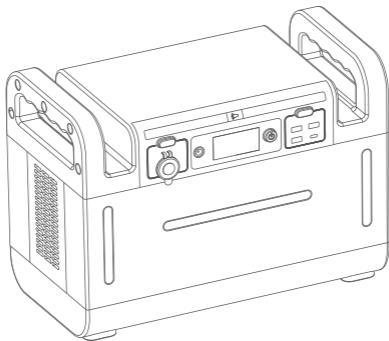

**Applicable to GT1500 / GT1200 / GT1000 product manual**

**Please read the instruction manual carefully before use**

# Introduction

---

- Thank you for purchasing Portable Power Station.
- This manual is written to guide you in the safe and effective use of your portablepower station.
- This manual describes the correct operation, inspection and care of this product. If this product is used incorrectly, it may cause electric shock, injury or otherlife-threatening dangers,so please read this manual carefully before using this product.
- After reading this manual, please keep it in a safe place for easy reference at any time.(Please note that the pictures in this manual are for illustrative-purposes only, and the product may be different from the pictures).
- Due to changes in specifications, the illustrations and contents of this manual may differ from the actual product contents in some cases.

## Precautions

For your safety and the safety of others, please follow the instructions below.

1. Before using the product, please read this manual to ensure that you fully understand how to use the product correctly.
2. Do not use this product for medical equipment, as this may cause accidents. When this product and charger are used, electromagnetic waves are generated. If you are using an implantable pacemaker or similar device, please check with your doctor or medical device manufacturer before using it.
3. Do not attempt to disassemble or modify this product, as this may cause overheating, fire or electric shock. Do not strongly impact or drop the product. If the product is deformed or damaged, please do not use the product. This may cause fire, burns, electric shock, or injury.
4. Do not damage the charger body, wires or plugs. Using damaged products may cause fire or electric shock.
5. Do not use the charger in places with a lot of steam, dust, oily smoke or corrosive gas. Do not expose the product to high temperature or corrosive gas. Do not put the product in the fire or heat it. Do not use this product near a fire, under the scorching sun, near a stove, in a hot car, or any other high-temperature place. Doing so may cause the product to overheat, rupture or catch fire.
6. Do not operate the product or charger with wet hands. This may cause electric shock. Do not let the product get wet with rain, water or sea water and other liquids. Do not use this product where it will be exposed to liquids. Do not use the product where it will come into contact with liquids, as this may cause overheating, fire or electric shock.
7. Do not connect the AC output to any wires of the power company or indoor wires, as this may cause electric shock or fire. When charging the product, be sure to use a dedicated adapter. When charging the product, Don't use random charger, as this may cause overheating or fire. Please use household power supply, DC vehicle power supply, and solar panels to charge the product battery. Please charge within the standard power supply voltage (Europe/China 220-240Vac/50Hz)/(US or Japanese version only supports 100-120Vac (50Hz/60Hz). Do not exceed the specified AC voltage, otherwise it will cause product failure, the company will not take the responsibility of providing free maintenance services.

8. Do not plug the accessory cigarette lighter car charging cable into the car cigarette lighter socket when it is not in use, because this may cause it to overheat or catch fire.
9. If you find any unusual smell, overheating, discoloration or deformation during charging, please unplug the charger from the socket. This may cause the battery to leak, overheat or catch fire. When connecting the power plug of electrical equipment to the machine, insert the plug firmly into the port. Failure to do so may result in electric shock or fire. If you notice any unusual smell, overheating, discoloration or deformation during the power supply process, please unplug the device from the socket. This may cause the battery to leak, overheat or burn.
10. Please keep it out of reach of children, otherwise it may cause electric shock or injury.
11. Do not store in a humid, dusty or high temperature environment. Because this may reduce the insulation performance, resulting in overheating or fire. Storage at high temperatures may also shorten the life of the battery.
12. This product should not be disposed of together with domestic garbage. Please dispose or recycle this product and battery in accordance with local regulations.

# Package content

**A: Portable Power Station X1**

**B: Adapter X1**

**C: Cigarette lighter car charger cable X1**

**D: Type-C line X1**

**E: User Manual X1**

**F: Storage bag X1**

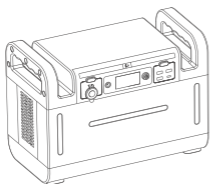

A



B



C



D



E

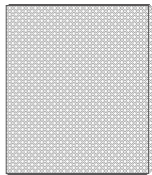

F

## Function description

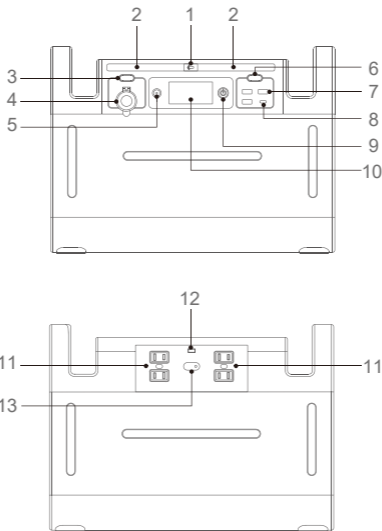

- 1. LED light button
- 2. LED lighting
- 3. DC output button
- 4. DC-cigarette lighter output port
- 5. DC (6530) input port

- 6. USB output button
- 7. USB output port
- 8. Type-C output port
- 9. POWER button
- 10. LED display
- 11. AC socket
- 12. 50Hz/60Hz frequency switch  
(Japanese standard only)
- 13. AC output button

## POWER button

Long press "POWER" to turn on, the LED display will light up, and the battery temperature display, OUTPUT, POWER, INPUT, WATTS, and battery icons will all light up. Press and hold the button for more than 3 seconds to turn off the product.

## AC output button

When using an AC outlet for output, turn on the power of the product and press the "AC output button". If you press this button while using AC output, the AC output will be turned off.

## DC output button

To use the DC cigarette lighter output, please turn on the product power and short press the "DC output button". If you press this button while using the on-board output, the on-board output will be turned off.

## USB Output button

When using USB and Type-C output, please turn on the power of the product and short press the "USB output button". If you press this button while using USB and Type-C output, the USB output will be turned off.

## LED light button

To use the LED lighting, please turn on the power of the product and short press the "LED light button". If you press the LED light button while using the LED light, the LED light will turn off.

## 50Hz/60Hz frequency switch (Japanese standard only)

\* AC frequency switch can be customized\*

Turn off the AC output before switching the 50Hz/60Hz frequency, switch the "frequency switch" to the terminal matching frequency position, and then press the AC output button, otherwise the wrong frequency will damage the electrical equipment.

## Display description

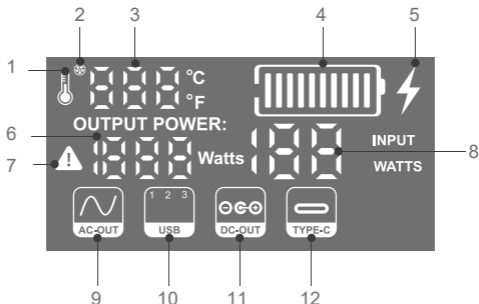

**1:**Temperature icon

**2:** The fan icon is ON , which means the fan is ON

**3:** Temperature value icon

**4:** Battery level icon

**5:** Fast charge icon

**6:** Output power value (updated once in 3S)

**7:** The warning icon is ON , which means abnormal temperature alarm

**8:** Input power value

**9:** The AC-OUT icon is ON to indicate that the AC inverter function is ON.

**Working output voltage**

**10:** The USB icon is ON to indicate that the USB output is on (3 USB ports simultaneously output power <25W)

**11:** The DC-OUT icon is ON, it means the cigarette lighter is turned on and output

**12:** The Type-C icon lights up to indicate that Type-C is working.



\*Long press the POWER button to turn ON, and the port output is turned on by the button, and the display shows the corresponding port icon.

\*When the product recognizes that there is a charging input, the green LED indicator is on. When the product is not fully charged, the battery icon in the display is indicated by a marquee, and the charging power prompt can be seen; the battery bar in the fully charged screen will be fixed and there is no power prompt (when the product is almost fully charged) .

It will enter trickle mode. It is recommended to continue charging for about 20minutes until the screen displays the input power as "00" or "01".

\*The product only allows the DC output port to work when charging, AC cannot work.

## Product features

---

1. When the battery pack voltage is 19.8V, the AC function of the product stops using, and the DC part of the function can continue to be used up to the battery pack voltage 18.2-18.6V. At this time, the product will enter the dormant state due to low voltage protection; the product must be charged at this time .
2. When the temperature is about -10°C, only the USB function and the LED light can be used normally; AC can be turned on when the ambient temperature is less than -5°C, USB/Type-C, and cigarette lighter plug-in can be turned on normally ( The temperature error is within  $\pm 2^{\circ}\text{C}$ ).
3. Due to the low temperature properties of lithium-ion iron phosphate batteries, it is recommended that the product be used in an environment above -3°C.
4. During the use of Type-C, pressing the POWER button will enter the dormant state. At this time, you need to unplug the Type-C cable before you can activate the product through the POWER button.

# Operation guide

## A: How to use USB/DC/Type-C output

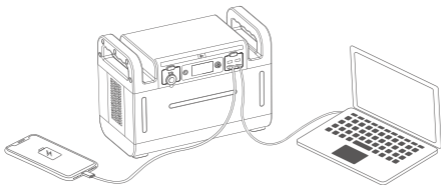

### A: How to use USB/DC/TYPE-C output

1. Long press "POWER" to turn on.
2. Short press the "USB/DC output button". The "USB""DC-OUT" "TYPE-C" icon lights up, and the USB / DC-OUT / TYPE-C output starts to work.
3. Insert the USB data cable, DC (car charging cable) or TYPE-C data cable plug for DC appliances to be used into the output port.
4. After using the DC appliance, pull out the plug and turn off the output button.

## B: How to use AC outlet output

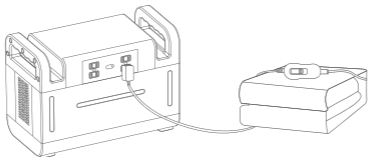

### B: How to use AC outlet output

1. Long "POWER" to turn ON.
2. Adjust the output "frequency switch" to select the appropriate frequency for the electrical appliances to be used(Japanese standard only).
3. Long press the AC output button; when "AC-OUT" appears on the LED display,the AC output starts to work.
4. Insert the AC plug of the equipment to be used into the AC socket of the product.
5. Unplug the electrical plug after use and turn off the AC output.

### C. How to use LED lighting

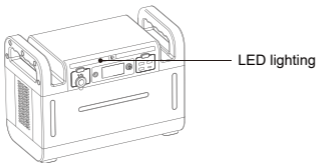

1. Long press "POWER" to turn on.
2. Short press the "LED light button" ,to mode 1: the LED light will be highlighted,
3. Short press the "LED light button",to mode 2: the LED light is on,
4. Short press the "LED light button" ,to mode 3: the LED light flashes,
5. Short press the "LED light button" ,to mode 4: the LED light enters the "SOS" mode,
6. Long press the "LED light button" in any mode for 2-3 seconds to turn off the LED light.

### D. How to change the AC output frequency (Japanese only)

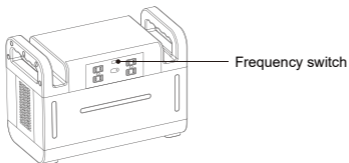

\* AC frequency can be customized \*

\*AC frequency can be switched between 50Hz and 60Hz\*

1. Long press "POWER" to turn on.
2. Check the frequency of the equipment to be used.
3. Adjust the AC output frequency switch to match the frequency of the equipment to be used.
4. Long press the AC output button, when "AC-OUT" appears on the LED display, the AC output starts to work.

# Charging method

There are 3 charging methods

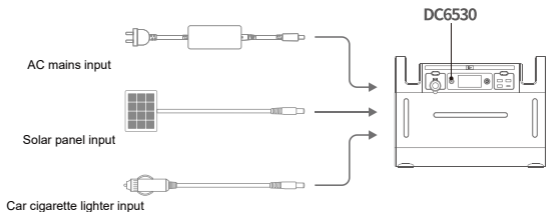

## 1. Charge with solar panels

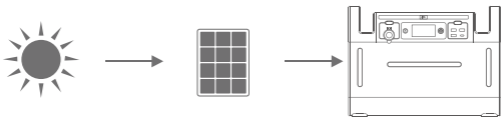

1. Place the solar panel (CTECHI optional solar panel is recommended) under direct sunlight.
2. When the solar panel output port is connected to the product input port, this product supports MPPT input voltage range 15~24V/input current 6-8A (18V200W recommended). When the battery icon on the display is indicated by a marquee, it means normal charging.
3. If the internal temperature of the product rises during the charging process, the cooling fan will be activated to cool the device by blowing air.
4. When the battery display is full and always on, the built-in overcharge protection circuit control module will be activated, and the charging will stop automatically, indicating that the charging is complete. Please remove the solar panel from the device.

## 2. Charge with AC adapter

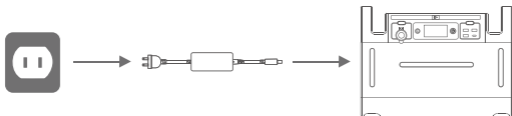

1. Connect the AC adapter to the power socket, and then connect the charging cable to the input of the product. When the power icon on the LED display is indicated by a marquee, it means normal charging.

2. Please use the standard adapter to charge the product, it takes about 7 hours to fully charge.

3. If the internal temperature of the product rises during the charging process, the cooling fan will be activated to cool the device by blowing air.





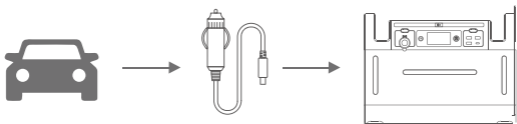





4. When the battery display is full and always on, it means charging is complete, the built-in overcharge protection circuit control module will be activated, and charging will stop automatically. Please disconnect the AC adapter from the device and the power socket in time.

### 3. Charge with car charger



1. Insert the provided cigarette lighter car charging cable into the car cigarette lighter seat and start the car.
2. Connect the DC head of the cigarette lighter car charging cable to the DC input port. This product supports car charging voltage range 12~14V/input current 10A. When the LED display shows the running water light cycle, it means normal charging.
3. During the charging process, when the internal temperature of the battery rises, the cooling fan is activated to cool the battery by blowing air.
4. When the battery display is full and always on, it means the charging is completed, the built-in overcharge protection circuit control module will be activated, and the charging will stop automatically. Please disconnect the car charging cable from the device and the car in time.

## Battery display

Battery indicator	State of charge
	S10:91-100%
	S9:81-90%
	S8:71-80%
	S7:61-70%
	S6:51-60%
	S5:41-50%
	S4:31-40%
	S3:21-30%
	S2:10-20%
	S1:1-10%

1. When the battery level is 0%, the battery frame flashes for 3 seconds, and it will automatically shut down. When the charger is plugged in to charge, the first bar will flash up.

2. When the power is between 1%-10%, one grid is always on, and it flashes upwards from the corresponding number of grids when charging (0.5S interval flashing).

3. When the power is between 11%-20%, the two bars are always on, and it flashes upwards from the corresponding number of bars when charging (0.5S interval flashing)
4. When the power is 21%-30%, the three bars are always on, and the corresponding number of bars flashes upwards when charging (0.5S interval flashing)
5. When the power is between 31%-40%, the four bars are always on, flashing upwards from the corresponding number of bars when charging (0.5S interval flashing)
6. When the battery level is between 41%-50%, the five bars are always on, and it flashes up from the corresponding number of bars when charging (0.5S interval flashing)
7. When the power is between 51%-60%, the six bars are always on, and it flashes upwards from the corresponding number of bars when charging (0.5S flashes at intervals)
8. When the battery level is between 61% and 70%, the seven bars are always on, and it flashes upwards from the corresponding number of bars when charging (0.5S flashes at intervals)
9. When the battery level is 71%-80%, the eight bars are always on, and it flashes upwards from the corresponding number of bars when charging (0.5S interval flashing)
10. When the power is 81%-90%, the nine bars are always on, and it flashes upwards from the corresponding number of bars when charging (0.5S interval flashing)
11. When the power is 91%-100%, ten bars are always on, flashing upwards from the corresponding number of bars when charging (0.5S interval flashing).

\*When the power of the product is fully charged, the charging current will decrease as the "charging power on the screen will also change", that is, when the product is almost full, the product will enter a trickle charging mode until the product is fully charged. In order to store the product for a long time, it is recommended to charge the product to 60%-80% every 3 months.



## Product specifications

<b>Product model</b>	GT1500	
<b>Capacity</b>	1210Wh	
<b>Voltage adjustment method</b>	sine wave	
<b>Input</b>	27V/8.5A, up to 180W	
<b>Cigarette lighter socket output</b>	12V=10A 120W	
<b>AC output</b> <small>(Customizable)</small>	US standard*4	100V-120V 60Hz Rated power: 1200W Peak value: 1700W
<b>USB-A*3</b>	5V-2.4A (12W)	
<b>Type-C output*1</b>	5V/9/12/15/20V (maximum 60W)	
<b>LED light</b>	2W	
<b>Battery</b>	Lithium iron phosphate battery	
<b>Use times</b>	more than 2000 times	
<b>Recharging temperature</b>	0° C~40° C	
<b>Operating temperature</b>	-10° C~40° C	
<b>Storage temperature</b>	-10° C~40° C	
<b>Safety protection</b>	temperature control, surge protection, short circuit protection, etc.	
<b>Size</b>	400*210*290mm	
<b>Weight</b>	16 kg	

## Common fault prompts and solutions

### **One: The product cannot be powered**

Please make sure that the POWER button and output button are turned on. (If the ambient temperature is not within the range of -10°C to 40°C, the power supply may not be available).

When connecting the power plug of electrical equipment to the machine, be sure to insert the plug to the root. If there is any water or foreign matter on the charger connector or charging input terminal, remove it.

Please check the remaining power on the display. If the remaining power is less than 10%, you need to recharge the portable emergency power supply.

Please check whether your device voltage and power consumption are higher than the output power limit of this product. If the upper limit is exceeded, short circuit protection, overcharge protection, over current protection, discharge protection, temperature protection, overload protection, etc. will be activated, and the portable emergency power supply will automatically shut down. Please check whether the protection circuit is normal.

### **Two: What are the common display fault prompts?**

1. When the USB is over-current or short-circuit protected, the port closes the output, and the USB icon flashes to warn.
2. When Type-C over-current or short-circuit protection, the port closes the output, and the Type-C icon flashes to warn.
3. When the cigarette lighter output over-current or short-circuit protection, the port closes the output, and the DC-OUT icon flashes to warn.
4. When AC continues to output to the low voltage of the product, the AC icon on the screen will report an error and flash, and the AC will turn off the output.

5. (1. When the AC output triggers the module over-temperature protection, the AC closes the output and automatically restores the output after the over-temperature state is released;
- (2. When the AC is overloaded, the inverter board AC shuts down the output; the "AC" on the screen will flash and alarm. After the overload state is removed, press the AC output button and the screen will clear the error message, and then restart the AC function button to restore the output.
- (3. When the AC is over-voltage, the AC closes the output, after removing the overvoltage state, restart the AC function key to restore the output
- (4. When the AC output is short-circuited, the AC closes the output. After the shortcircuit state is removed, restart the AC function key to restore the output
6. When the battery is 65°C over temperature protection, all outputs will be turned off. The temperature value shows the highest battery temperature value. The temperature icon and temperature value flash at the same time (1 flash for 1 second), and the fan works until the battery over temperature protection is released.
7. The display is completely black, disconnect all electrical equipment on the product. After charging the power for 2-3 minutes, turn on the POWER button and the display will be reset.

**Three: When I charge the portable power supply, the adapter becomes very hot, is this normal?**

Our portable power supply is equipped with an AC adapter . According to safety standards, the maximum temperature of the adapter is 75°C. For your safety, the configured adapter has passed UL, CE, GS, PSE, TUV, ETL, CCC and other certifications.



## Warranty policy

---

### No copy

This guarantee guarantees that the product will be replaced free of charge under the conditions stipulated in the guarantee policy.

Please read the guarantee carefully and keep it in a safe place.

1. Only when the product is used in accordance with the instructions in the operating instructions and fails within the warranty period, it will be replaced. Products replaced during the warranty period become the property of the company.

2. To get a warranty replacement, please send this warranty card together with the product. The shipping cost of returning the product for replacement is the customer's responsibility.

3. Under the following conditions, it will not be replaced during the warranty period

1) Failure or damage caused by failure to follow the precautionary measures described in the instruction manual.

2) Failure or damage caused by improper storage and storage (complete discharge).

3) Failure or damage caused by the use of a non-designated power adapter.

4) Failure or damage caused by improper repair, disassembly or modification.

5) Failure or damage caused by falling, vibration, water leakage, condensation, etc. after purchase.

6) Failure or damage caused by fire, earthquake, flood or other natural disasters.

7) Any appearance change or discoloration caused by use.

8) Failure or damage caused by use at temperatures other than the applicable operating temperature.

4. There is no guarantee for secondary damage caused by the malfunction of this product.

5. We are not responsible for any failure or malfunction of other equipment caused by the use of this product.

6. This manual is only valid for use in (this sales area), and the company has the final interpretation right.

7. This manual will not be reissued, so please keep it in a safe place.

8. If the dealer's name is not written or stamped, please submit the proof of the date of purchase and the dealer's name to the dealer who purchased the product, such as a receipt issued by the dealer.

If you do not have such proof, please contact yourdealer or the company which you purchased the product.

If you purchased the product in our online store, you must provide proof of the date of purchase, such as a screenshot of the invoice, order number or order history, together with this warranty card. Failure to do so will invalidate the warranty.

## Warranty card

<b>Model is</b>	<b>GT1500/GT1200/GT1000</b>
<b>Purchase Date</b>	
<b>Warranty period</b>	<b>1 year from the purchase date</b>
<b>Name:</b>	
<b>address:</b>	
<b>E-mail:</b>	
<b>Seller's name:</b>	

**PPS**