

LFP Series

Pure Sine Wave Inverter/Charger

User's Manual

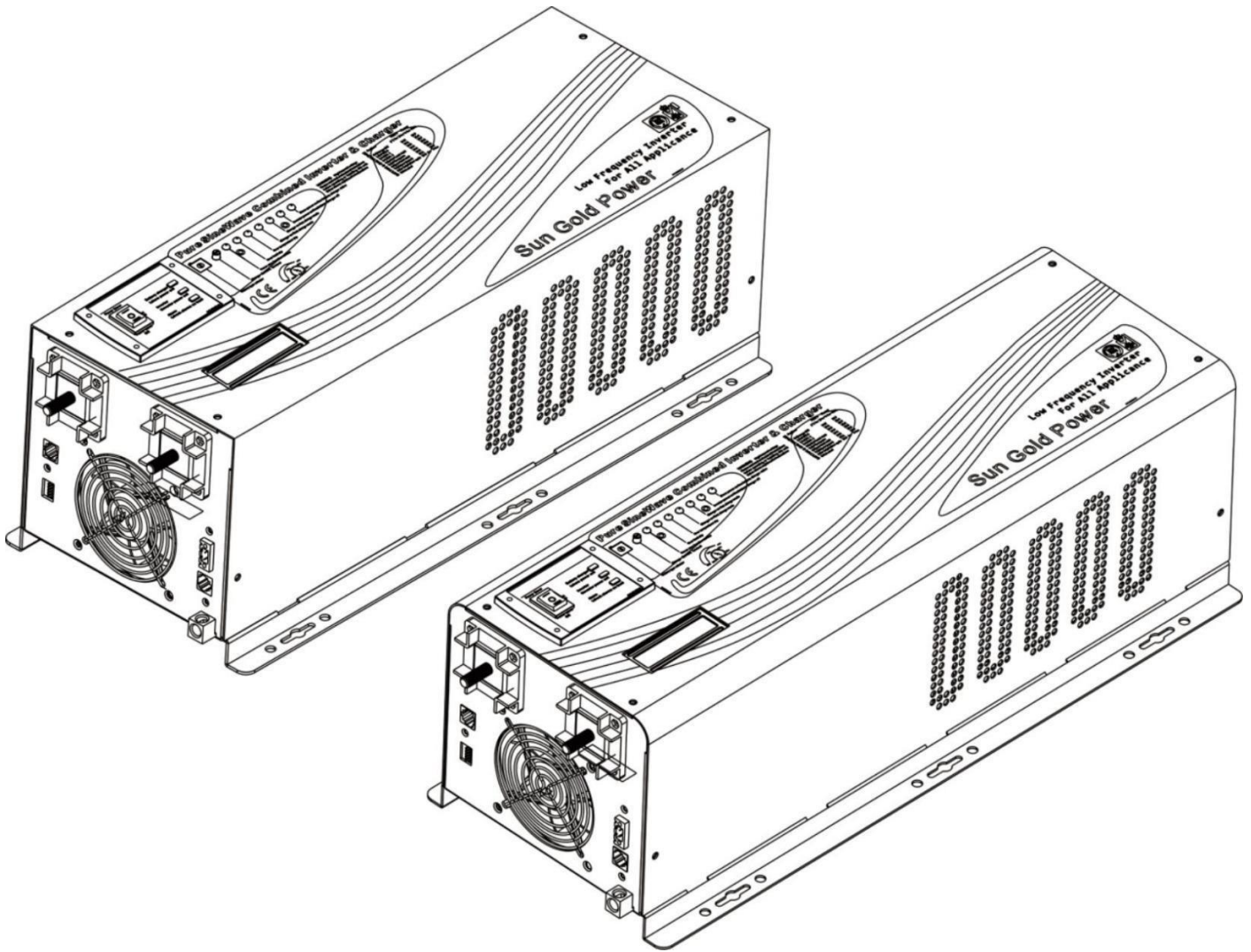

Table of Contents

1 Important Safety Information	- 2-
1.1 General Safety Precautions7.....	- 2-
1.2 Precautions When Working with Batteries.....	- 2-
2 Introduction.....	- 3-
2.1 General Information.....	- 3-
2.2 Application.....	- 3-
2.3 Features.....	- 3-
2.4 Mechanical Drawing.....	- 4-
2.5 Electrical Performance.....	- 7-
2.5.1 AC Charger.....	- 7-
2.5.2 Inverter.....	- 9-
2.5.3 Auto frequency adjust.....	- 9-
2.5.4 DIP Switches.....	- 9-
2.5.5 Transfer.....	- 10-
2.5.6 Power Saver Mode.....	- 10-
2.5.7 Protections.....	- 11-
2.5.8 LED Indicator & LCD.....	- 12-
2.5.9 Automatic Voltage Regulation(Optional).....	- 12-
2.5.10 Remote control.....	- 13-
2.5.11 Audible Alarm.....	- 14-
2.5.12 FAN Operation.....	- 14-
2.5.13 Other features.....	- 14-
3 Installation.....	- 16-
3.1 Location.....	- 16-
3.2 DC Wiring recommendation.....	- 16-
3.3 AC Wiring.....	- 16-
3.4 Grounding.....	- 18-
3.4.1 Automatic Neutral-to-Ground Connection.....	- 18-
3.4.2 Disabling the Automatic Neutral-to-Ground Connection.....	- 18-
3.5 Install Flange.....	- 19-
4 Troubleshooting Guide.....	- 20-
5 Warranty.....	- 23-
Appendix 1.....	- 24-
Appendix 2 - Installation Diagram.....	- 26-

1 Important Safety Information



WARNING!

This manual contains important instructions for all LFP Inverter/Charger models that shall be followed during installation and maintenance of the inverter.

1.1 General Safety Precautions

1-1-1. Do not expose the Inverter to rain, snow, spray, bilge or dust. To reduce risk of hazard, do not cover or obstruct the ventilation openings. Do not install the Inverter in a zero-clearance compartment. Overheating may result. Allow at least 30CM(11.81 inches) of clearance around the inverter for air flow. Make sure that the air can circulate freely around the unit. A minimum air flow of 145CFM is required.

1-1-2. To avoid a risk of fire and electronic shock. Make sure that existing wiring is in good electrical condition; and that wire size is not undersized. Do not operate the Inverter with damaged or substandard wiring.

1-1-3. This equipment contains components which can produce arcs or sparks. To prevent fire or explosion do not install in compartments containing batteries or flammable materials or in locations which require ignition protected equipment. This includes any space containing gasoline-powered machinery, fuel tanks, or joints, fittings, or other connection between components of the fuel system.

See Warranty for instructions on obtaining service.

1-1-4. Do not dis-assemble the Inverter/Charger. It contains no user serviceable parts. Attempting to service the Inverter/Charger yourself may result in a risk of electrical shock or fire. Internal capacitors remain charged after all power is disconnected.

1-1-5. To reduce the risk of electrical shock, disconnect both AC and DC power from the Inverter/Charger before attempting any maintenance or cleaning. Turning off controls will not reduce this risk

CAUTION: Equipment damage

The output side of the inverter's AC wiring should at no time be connected to public power or a generator. This condition is far worse than a short circuit. If the unit survives this condition, it will shut down until corrections are made.

Installation should ensure that the inverter's AC output is, at no time, connected to its AC input.

Warning: Limitations On Use

SPECIFICALLY, PLEASE NOTE THAT THE LFP SERIES INVERTER/CHARGER SHOULD NOT BE USED IN CONNECTION WITH LIFE SUPPORT SYSTEMS OR OTHER MEDICAL EQUIPMENT OR DEVICES.

1.2 Precautions When Working with Batteries

1-2-1. If battery acid contacts skin or clothing, wash immediately with soap and water. If acid enters eye, immediately flood eye with running cold water for at least 20 minutes and get medical attention immediately.

1-2-2. Never smoke or allow a spark or flame in vicinity of battery or engine.

1-2-3. Do not drop a metal tool on the battery. The resulting spark or short-circuit on the battery or other electrical part may cause an explosion.

1-2-4. Remove personal metal items such as rings, bracelets, necklaces, and watches when working with a lead-acid battery. A lead-acid battery produces a short-circuit current high enough to weld a ring or the like to metal, causing a severe burn.

1-2-5. To reduce the risk of injury, charge only rechargeable batteries such as deep-cycle lead acid, lead antimony, lead calcium gel cell, absorbed mat, NiCad/NiFe or Lithium battery. Other types of batteries may burst, causing personal injury and damage.

2 Introduction

2.1 General Information

This Series Pure Sine Wave Inverter is a combination of an inverter, battery charger and AC auto-transfer switch into one complete system with a peak conversion efficiency of 88%.

It is packed with unique features and it is one of the most advanced inverter/chargers in the market today. It features power factor corrected, sophisticated multi-stage charging and pure sine wave output with unprecedentedly high surge capability to meet demanding power needs of inductive loads without endangering the equipment.

For the regular model, when utility AC power cuts off(or falls out of acceptable range), the transfer relay is de-energized and the load is automatically transferred to the Inverter output. Once the qualified AC utility is restored, the relay is energized and the load is automatically reconnected to AC utility.

The LFP Series Inverter is equipped with a powerful charger of up to 110Amps (depending on model).

The overload capacity is 300% of continuous output for up to 20 seconds to reliably support tools and equipment longer

Another important feature is that the inverter can be easily customized to Battery priority via a DIP switch, this helps to extract maximum power from battery in renewable energy systems.

Thus, the LFP Series Pure Sine Wave Inverter is suitable for Renewable energy system, Utility, RV, Marine and Emergency appliances.

To get the most out of the power inverter, it must be installed, used and maintained properly. Please read the instructions in this manual before installing and operating.

2.2 Application

Power tools—circular saws, drills, grinders, sanders, buffers, weed and hedge trimmers, air compressors.

Office equipment – computers, printers, monitors, facsimile machines, scanners.

Household items – vacuum cleaners, fans, fluorescent and incandescent lights, shavers, sewing machines.

Kitchen appliances – coffee makers, blenders, ice makers, toasters.

Industrial equipment – metal halide lamp, high – pressure sodium lamp.

Home entertainment electronics – television, VCRs, video games, stereos, musical instruments, satellite equipment.

2.3 Features

- ❖ **Smart Remote Control (RMT)**
- ❖ **Designed to Operate under Harsh Environment**
- ❖ **DC Start & Automatic Self-Diagnostic Function**
- ❖ **Compatible with Both Linear & Non-Linear Load**
- ❖ **Easy to Install & Easy to Operate & Easy to Solve**
- ❖ **Low DC Voltage Supports Home & Office Appliances**
- ❖ **Powerful Charge Rate Up to 120Amp, Selectable From 0%-100%**
- ❖ **High Efficiency Design & “Power Saving Mode” to Conserve Energy**
- ❖ **Battery Priority Mode, Designates the Inverter-Preferred UPS Configuration**
- ❖ **13 Vdc Battery Recover Point, Dedicated for Renewable Energy Systems**
- ❖ **8 pre Set Battery Type Selector plus De-sulphation for Totally Flat Batteries**
- ❖ **4-step Intelligent Battery Charging, PFC (Power Factor Correction) for Charger**
- ❖ **8 ms Typical Transfer Time Between Utility & Battery, Guarantees Power Continuity**
- ❖ **15s Delay Before Transfer when AC Resumes, Protection for Load when Used with Generator**

2.4 Mechanical Drawing

LFP 1KW to 1.5KW Models

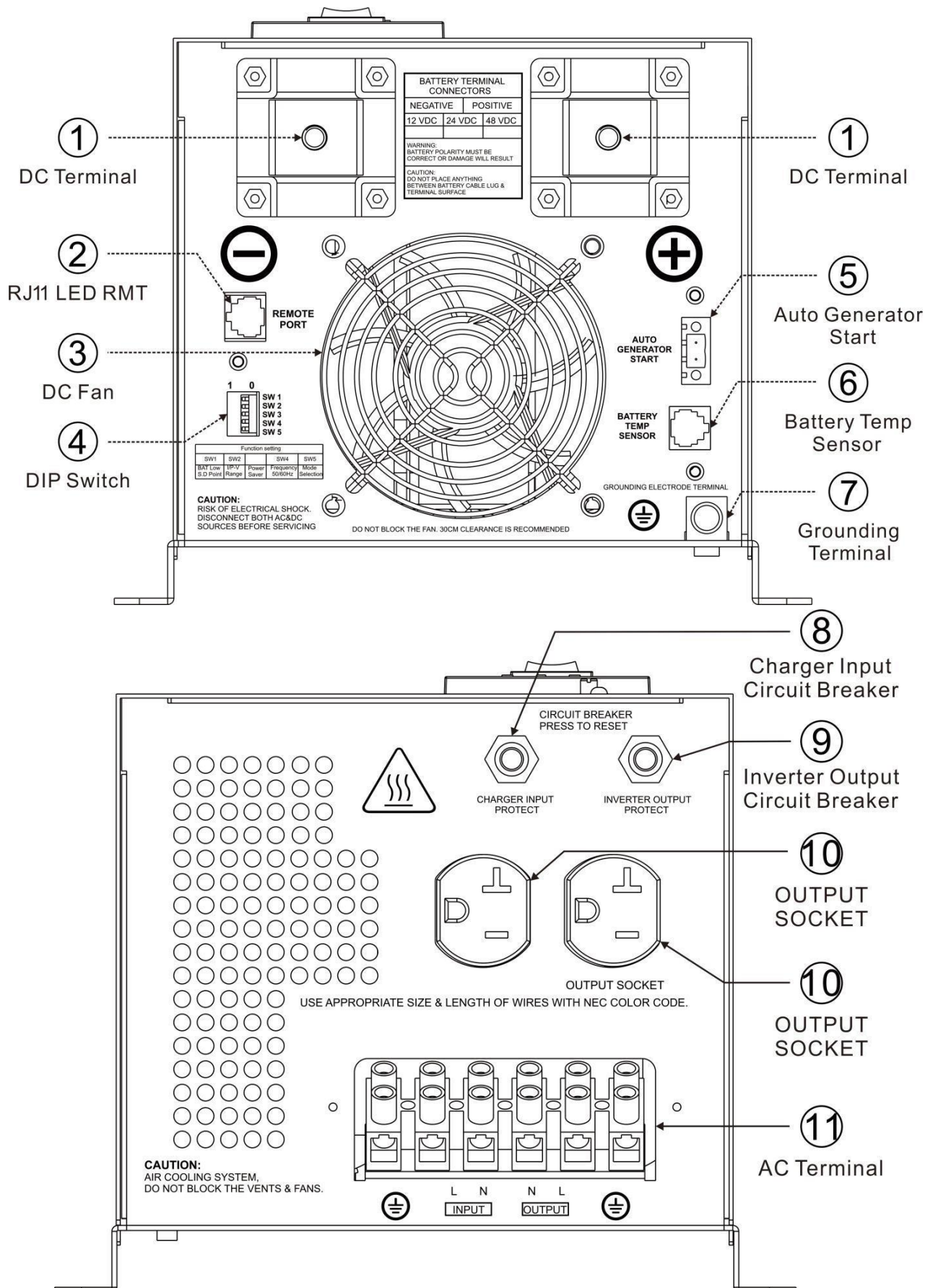

LFP 2KW to 3KW Models

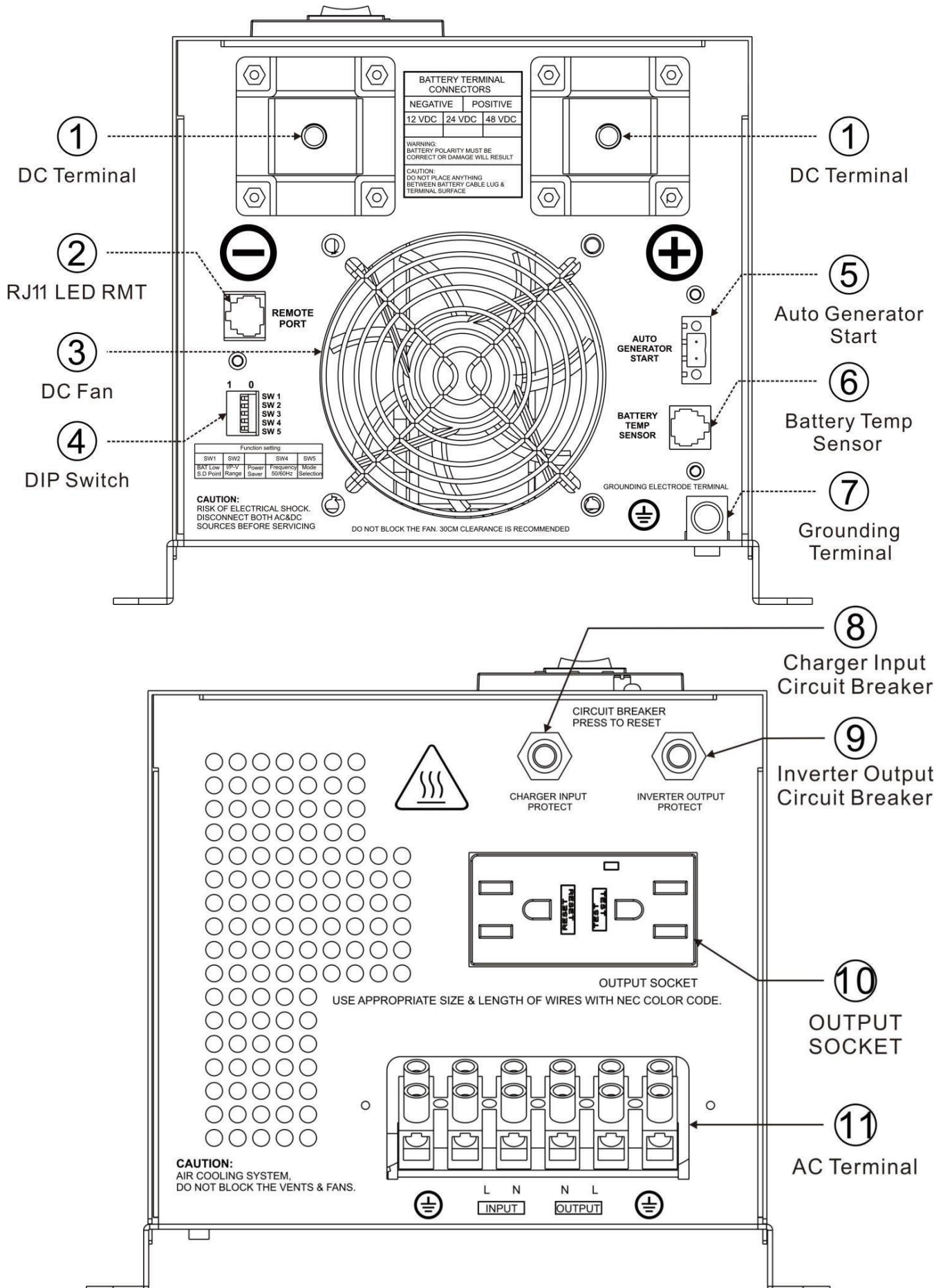

LFP 4KW to 6KW Models

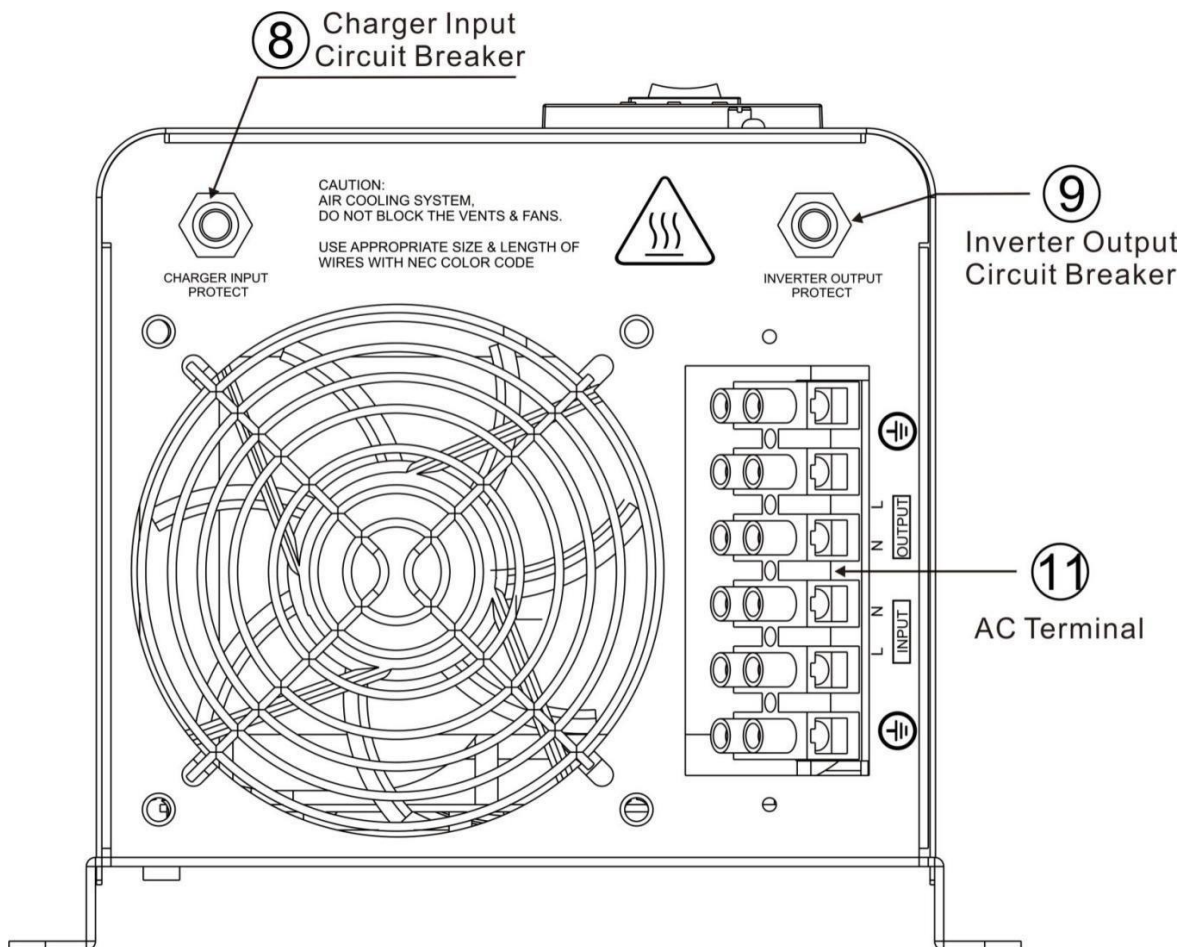
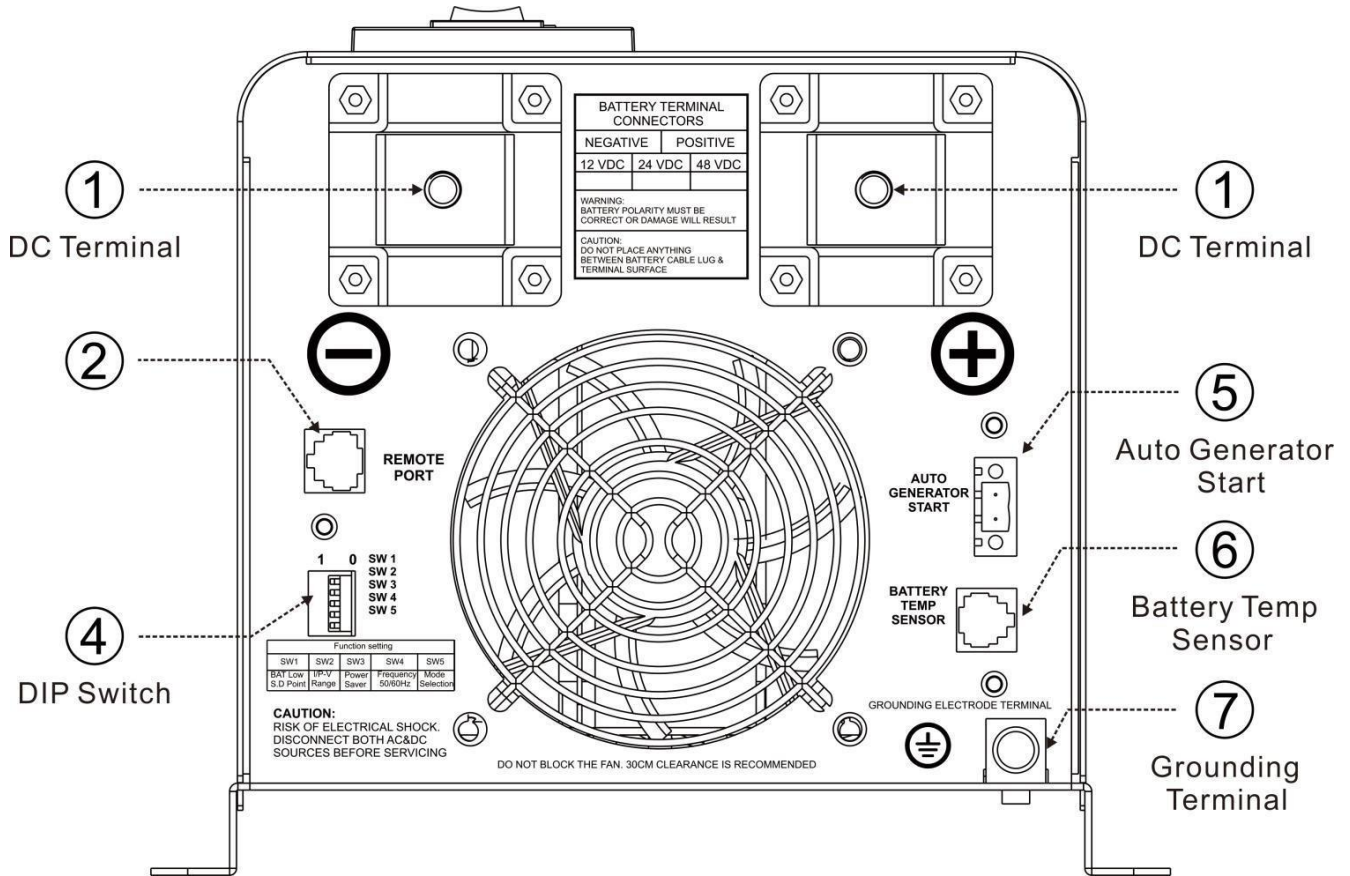

2.5 Electrical Performance

2.5.1 AC Charger

LFP Series is equipped with an active PFC (Power Factor Corrected) multistage battery charger. The PFC feature is used to control the amount of power used to charge the batteries in order to obtain a power factor as close as possible to 1.

Unlike other inverters whose max charging current decreases according to the input AC voltage, LFP series charger is able to output max current as long as input AC voltage is in the range of 164-243VAC (95-127VAC for 120V model), and AC freq is in the range of 48-54Hz(58-64Hz for 60Hz model).

The LFP series inverter is with a strong charging current of 120Amp (for 4KW,12V), and the max charge current can be adjusted from 0%-100% via a liner switch at the right of the battery type selector. This will be helpful if you are using our powerful charger on a small capacity battery bank. Fortunately, the liner switch can effectively reduce the max charging current to 20% of its peak.

Choosing "0" in the battery type selector will disable charging function.

There are mainly 3 stages:

Bulk Charging: This is the initial stage of charging. While Bulk Charging, the charger supplies the battery with controlled constant current. The charger will remain in Bulk charge until the Absorption charge voltage (determined by the Battery Type selection) is achieved.

Software timer will measure the time from A/C start until the battery charger reaches 0.3V below the boost voltage, then take this time as T_0 and $T_0 \times 2 = T_1$.

Absorb Charging: This is the second charging stage and begins after the absorb voltage has been reached. Absorb Charging provides the batteries with a constant voltage and reduces the DC charging current in order to maintain the absorb voltage setting.

In this period, the inverter will start a T_1 timer; the charger will keep the boost voltage in Boost CVmode until the T_1 timer has run out. Then drop the voltage down to the float voltage. The timer has a minimum time of 1 hour and a maximum time of 12 hours.

Float Charging: The third charging stage occurs at the end of the Absorb Charging time. While Float charging, the charge voltage is reduced to the float charge voltage (determined by the Battery Type selection*). In this stage, the batteries are kept fully charged and ready if needed by the inverter.

If the A/C is reconnected or the battery voltage drops below 12Vdc/24Vdc/48Vdc, the charger will reset the cycle above.

If the charge maintains the float state for 10 days, the charger will deliberately reset the cycle to protect the battery.

Table 2.5.1 Battery Charging Processes

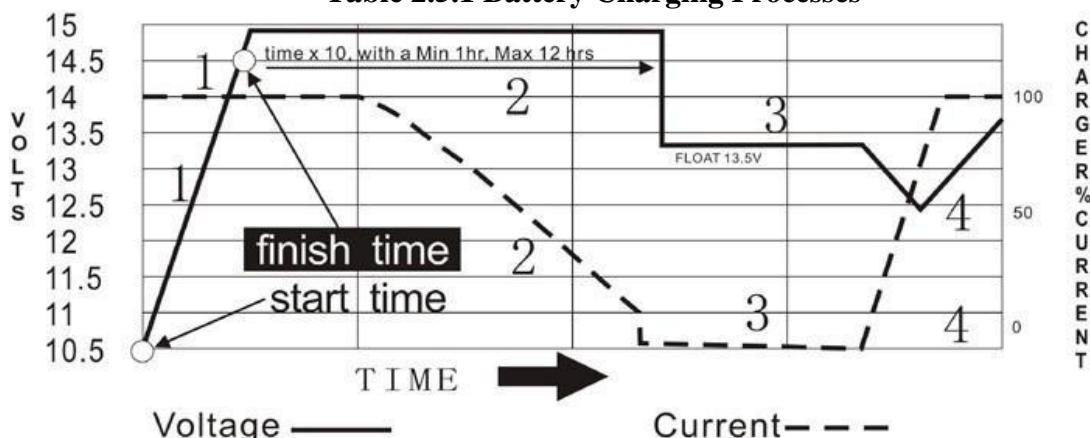

THE NEW BATTERY CHARGERS AND BOOSTERS OFFER THE FASTEST CHARGE RATE CURRENTLY AVAILABLE

STEP 1= Bulk Charge (Constant Current)
STEP 3= Float Voltage

STEP 2 = Absorption (Constant Voltage)
STEP 4 = RESET TO STEP 1

*2 FOR 24 VOLTS
*4 FOR 48 VOLTS

ADJUSTABLE TIME DEPENDING ON BATTERY BANK CAPACITY

Table 2.5.2 Battery Type Selector

Switch Setting	Description	Fast Mode/ VDC	Float Mode / VDC
0	Charger Off		
1	Gel USA	14.0	13.7
2	AGM 1	14.1	13.4
3	Lithium	13.8	13.6
4	Sealed Lead Acid	14.4	13.6
5	Gel EURO	14.4	13.8
6	Open Lead Acid	14.8	13.3
7	LiFePO4	14.0	13.8
8	De-sulphation	15.5 (4 Hours then Off)	
9	Classic LFP	13.6	13.5

For 12Vdc Mode Series (*2 for 24Vdc Mode ; *4 for 48Vdc Mode)

Use with Lithium Ion Battery Packs

Our inverter charger can work with various lithium batteries like LiFePO4, LFP battery. Please check the battery specification to make sure the charging setting of inverter suits your lithium battery charge voltage and cut off voltages.

If the charging setting of the inverter don' t match your lithium battery, please email your requirement to sales@sungoldpower.com for customization.

De-sulphation

The de-sulphation cycle on switch position 8 is marked in red because this is a very dangerous setting if you do not know what you are doing. Before ever attempting to use this cycle you must clearly understand what it does and when and how you would use it.

What causes sulphation? This can occur with infrequent use of the batteries(nor), or if the batteries have been left discharged so low that they will not accept a charge. This cycle is a very high voltage charge cycle designed to try to break down the sulphated crust that is preventing the plates taking a charge and thus allow the plates to clean up and so accept charge once again.

Charging depleted batteries

The LFP series inverter allows start up and through power with depleted batteries.

For 12VDC model, after the battery voltage goes below 10V, if the switch is still (and always) kept in "ON" position, the inverter is always connected with battery, and the battery voltage does not drop below 2V, the inverter will be able to charge the battery once qualified AC inputs are present.

Before the battery voltage goes below 9VDC, the charging can be activated when the switch is turned to "Off", then to "ON".

When the voltage goes below 9VDC, and you accidently turn the switch to OFF or disconnect the inverter from battery, the inverter will not be able to charge the battery once again, because the CPU loses memory during this process.

Tabel 2.5.3 AC Charging Current for OIS model

Model Watt	Battery Voltage	AC Charger Current Max	Model Watt	Battery Voltage	AC Charger Current Max
1.000 ~ 1.500	12 Vdc	45 ± 5 Amp	2.000	12 Vdc	70 ± 5 Amp
	24 Vdc	25 ± 5 Amp		24 Vdc	25 ± 5 Amp
	48 Vdc	15 ± 5 Amp		48 Vdc	20 ± 5 Amp
3.000	12 Vdc	90 ± 5 Amp	4.000	12 Vdc	120 ± 5 Amp
	24 Vdc	40 ± 5 Amp		24 Vdc	50 ± 5 Amp
	48 Vdc	30 ± 5 Amp		48 Vdc	40 ± 5 Amp
5.000	24 Vdc	80 ± 5 Amp	6.000	24 Vdc	90 ± 5 Amp
	48 Vdc	50 ± 5 Amp		48 Vdc	60 ± 5 Amp

The charging capacity will go to peak in around 3 seconds. This may cause a generator to drop frequency, making inverter transfer to battery mode.

It is suggested to gradually put charging load on the generator by switching the charging switch from min to max, together with the 15s switch delay, our inverter gives the generator enough time to spin up. This will depend on the size of the generator and rate of charge.

2.5.2 Inverter

Topology

The LFP inverter/charger is built according to the following topology.

Inverter: Full Bridge Topology.

AC Charger: Isolate Boost Topology

Because of high efficiency Mosfets and 16bit, 4.9MHz microprocessor and heavy transformers, it outputs PURE SINE WAVE AC with an average THD of 10% (Min5%, Max 15%) depending of load connected and battery voltage.

The peak efficiency of LFP series is 88%.

Overload Capacity

The LFP series inverters have different overload capacities, making it ideal to handle demanding loads.

1 For 110% < Load < 125% ($\pm 10\%$), no audible alarm in 14 minutes, beeps 0.5s every 1s in the 15th minute, and Fault(Turn off) after the 15th minute.

2 For 125% < Load < 150% ($\pm 10\%$), beeps 0.5s every 1s and Fault(Turn off) after the 1 minute.

3 For 300% \cong Load > 150% ($\pm 10\%$), beeps 0.5s every 1s and Fault(Turn off) after 20s.

2.5.3 Auto frequency adjust

The inverter is with Auto Frequency adjust function.

The factory default configuration for 220/230/240VAC inverter is 50Hz, and 60Hz for 100/110/120VAC inverter. While the output freq can be easily changed once a qualified freq is applied to the inverter.

If you want to get 60Hz from a 50Hz inverter, just input 60Hz power, and the inverter will automatically adjust the output freq to 60Hz and vice versa.

2.5.4 DIP Switches

On the rear panel of inverter, there are 5 DIP switches which enable users to customize the performance of the device.

Table 2.5.11 OIS Series Dip Switch Function Setting

Switch NO	Switch Function	Position: 0	Position: 1
SW1	Low Battery Trip Volt	10.0VDC	10.5VDC
		*2 for 24VDC, *4 for 48VDC	
SW2	AC Input Range	184-253VAC	140-270VAC
		100-135VAC	90-135VAC
SW3	Power Saver Auto Setting	Night charger Function	Detect load Per 3Secs
SW4	O/P Frequency Setting	50HZ	60HZ
SW5	Battery/AC Priority	Utility Priority	Battery Priority

SW1: Low Battery Trip Volt:

For 12VDC model, the Low Battery Trip Volt is set at 10.0Vdc by typical deep cycle lead acid battery. It can be customized to 10.5Vdc using SW1 for sealed car battery, this is to prevent batteries from over-discharging while there is only a small load applied on the inverter. (*2 for 24VDC, *4 for 48VDC)

SW2:AC Input Range:

There are different acceptable AC input ranges for different kinds of loads.

For some relatively sensitive electronic devices, a narrow input range of 184-253VAC (100-135V for 120VAC model) is required to protect them.

While for some resistive loads which work in a wide voltage range, the input AC range can be customized to 154-253VAC (90-135V for 120VAC model), this helps to power loads with the most AC input power without frequent switches to the battery bank.

SW3:Power Saver Auto Setting :

The inverter is factory defaulted to detect load for 250ms in every 30 seconds. This cycle can be customized to 3 seconds through the SW3 on the DIP switch.

SW4: Adjust 50hz/60hz

The output frequency of the inverter can be set at either 50Hz or 60Hz by SW4.

SW5:Solar/AC Priority:

Our inverter is designed with AC priority by default. This means, when AC input is present, the battery will be charged first, and the inverter will transfer the input AC to power the load. Only when the AC input is stable for a continuous period of 15 days, the inverter will start a battery inverting cycle to protect the battery. After 1 cycle normal charging and ac through put will be restored.

The AC Priority and Battery Priority switch is SW5. When you choose battery priority, the inverter will inverting from battery despite the AC input. Only when the battery voltage is reaches low voltage alarm point(10.5V for 12V), the inverter transfers to AC Input, charges battery, and switches back to battery when battery is charged full. This function is mainly for wind/solar systems taking utility power as back up.

2.5.5 Transfer

While in the Standby Mode, the AC input is continually monitored. Whenever AC power falls below the VAC Trip voltage (154 VAC, default setting for 230VAC,90VAC for 120VAC), the inverter automatically transfers back to the Invert Mode with minimum interruption to your appliances - as long as the inverter is turned on. The transfer from Standby mode to Inverter mode occurs in approximately 8 milliseconds. And it is the same time from Inverter mode to Standby mode.

Though it is not designed as a computer UPS system, this transfer time is usually fast enough to keep your equipment powered up.

There is a 15-second delay from the time the inverter senses that continuously qualified AC is present at the input terminals to when the transfer is made. This delay is built in to provide time for a generator to spin-up to a stable voltage and avoid relay chattering. The inverter will not transfer to generator until it has locked onto the generator's output. This delay is also designed to avoid frequent switching when input utility is unstable.

2.5.6 Power Saver Mode

There are 3 different working status for LFP inverter: "Power Saver Auto" 、 "Power Saver Off" and "Power Off".

When power switch is in "Unit Off" position, the inverter is powered off.

When power switch is turned to either of "Power Saver Auto" or "Power Saver Off", the inverter is powered on.

Power saver function is designed to conserve battery power when AC power is not or rarely required by the loads.

In this mode, the inverter pulses the AC output looking for an AC load (i.e., electrical appliance). Whenever an AC load (greater than 25 watts) is turned on, the inverter recognizes the need for power and automatically starts inverting and output goes to full voltage. When there is no load (or less than 25 watts) detected, the inverter automatically goes back into search mode to minimize energy consumption from the battery bank.

In "Power saver on" mode, the inverter will draw power mainly in sensing moments, thus the idle consumption is significantly reduced.

The inverter is factory defaulted to detect load for 250ms every 30 seconds. This cycle can be customized to 3 seconds turn SW3 on the DIP switch.



Note: The minimum power of load to take inverter out of sleep mode (Power Saver On) is 25 Watts.

When in the search sense mode, the green power LED will blink and the inverter will make a ticking sound. At full output voltage, the green power LED will light steadily and the inverter will make a steady humming sound. When the inverter is used as an “uninterruptible” power supply the search sense mode or “Power Saver On” function should be defeated.

Exceptions

Some devices when scanned by the load sensor cannot be detected. Small fluorescent lights are the most common example. (Try altering the plug polarity by turning the plug over.) Some computers and sophisticated electronics have power supplies that do not present a load until line voltage is available. When this occurs, each unit waits for the other to begin. To drive these loads either a small companion load must be used to bring the inverter out of its search mode, or the inverter may be programmed to remain at full output voltage.

2.5.7 Protections

The LFP series inverter is equipped with extensive protections against various harsh situations/faults.

These protections include:

AC Input over voltage protection/AC Input low voltage protection

Low battery alarm/High battery alarm

Over temperature protection/Over load protection

Short Circuit protection (1s after fault)

Back feeding protection

When Over temperature /Over load occur, after the fault is cleared, the master switch has to be reset to restart the inverter.

The Low batter voltage trip point can be customized from defaulted value 10VDC to 10.5VDC thru the SW1 on DIP switch.

The inverter will go to Over temp protection when heat sink temp. $\geq 105^{\circ}\text{C}$, and go to Fault (shutdown Output) after 30 seconds. The switch has to be reset to activate the inverter.

The LFP series Inverter has back feeding protection which avoids presenting an AC voltage on the AC input terminal in Invert mode.

After the reason for fault is cleared, the inverter has to be reset to start working.

2.5.8 LED Indicator & LCD

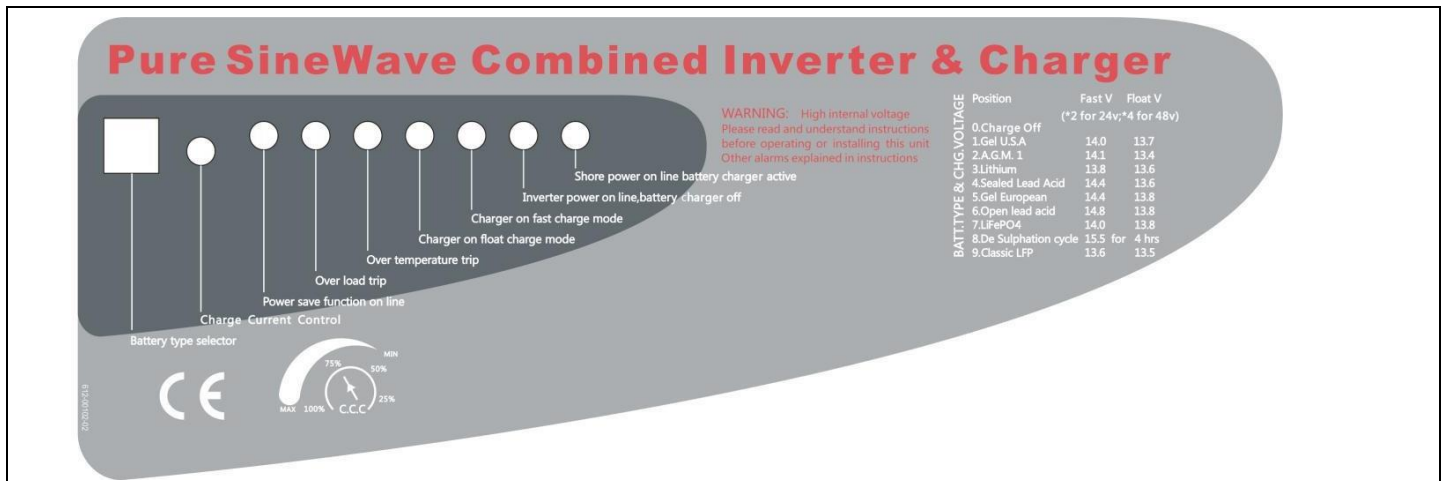

SHORE POWER ON	GREEN LED lit in AC Mode
INVERTER ON	GREEN LED lit in Inverter Mode
FAST CHARGE	Yellow LED lit in Fast Charging Mode
FLOAT CHARGE	GREEN LED lit in Float Charging Mode
OVER TEMP TRIP	RED LED lit in Over Temperature
OVER LOAD TRIP	RED LED lit in Over Load
POWER SAVER ON	GREEN LED lit in Power Saver Mode (Power Saver Load \leq 25W)

Table 2.5.8 LCD

Indicator

<p>1 Greeting message</p>	<p>2 AC Status & Input Voltage</p> <p>“AC: abnormal” will be displayed when AC input is not qualified.</p>
<p>3 Output Voltage/Frequency and Battery voltage</p>	<p>4 Output Current(in percentage)</p>

2.5.9 Automatic Voltage Regulation(Optional)

The automatic voltage regulation function is for full series of LFP Pure Sine Wave Inverter/ Charger except split phase models including LFP 1000W~6000W.

Instead of simply bypassing the input AC to power the loads, the LFP series inverter stabilizes the input AC voltage to a range of 230V/120V \pm 10%.

Connected with batteries, the LFP Series inverter will function as a UPS with max transfer time of 10 ms.

With all the unique features our inverter provides, it will bring you long-term trouble free operation beyond your expectation.

Function Introduction

Table 2.5.5 Input Voltage Transfer Points

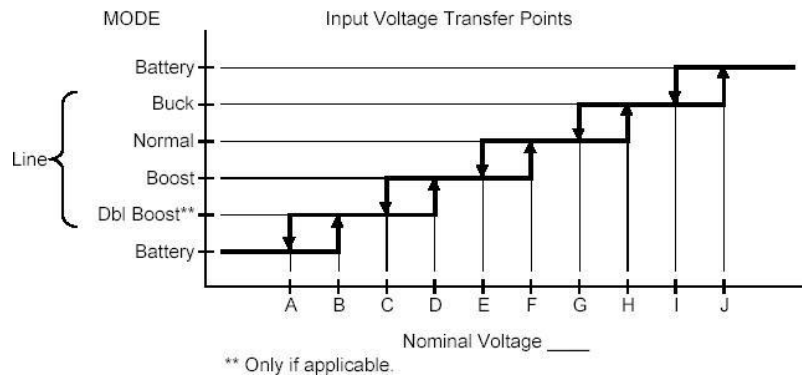

OIS Function	OIS					
	LV (NA/JPN)			HV (INTL)		
Acceptable Input Voltage Range (Vac)	0-160			0-300		
Nominal Input Voltages (Vac)	100	110	120	220	230	240
(A) Line low loss N/W (On battery)	75/65	84/72	92/78	168/143	176/150	183/156
(B) Line Low comeback N/W (On Boost)	80/70	89/77	97/83	178/153	186/160	193/166
(C) Line 2nd boost threshold (On Boost)	**	**	**	**	**	**
(D) Line 2nd boost comeback (On Normal)	**	**	**	**	**	**
(E) Line 1st boost threshold (On Boost)	90	99	108	198	207	216
(F) Line 1st boost comeback (On Normal)	93	103	112	205	215	225
(G) Line buck comeback (On Normal)	106	118	128	235	246	256
(H) Line buck threshold (On Buck)	110	121	132	242	253	264
(I) Line high comeback (On Buck)	115	127	139	253	266	278
(J) Line high loss (On Battery)	120	132	144	263	276	288

2.5.10 Remote control



Apart from the switch panel on the front of the inverter, an extra switch panel connected to the RJ11 port at the DC side of the inverter thru a standard telephone cable can also control the operation of the inverter. If an extra switch panel is connected to the inverter via “remote control port”, together with the panel on the inverter case, the two panels will be connected and operated in parallel. Whichever first switches from “Off” to “Power saver off” or “Power saver on”, it will power the inverter on. If the commands from the two panels conflict, the inverter will accept command according to the following priority:
 Power saver on> Power saver off> Power off
 Only when both panels are turned to “Unit Off” position will the inverter be powered off.
 The Max length of the cable is 10 meters.



Never cut the telephone cable when the cable is attached to inverter and battery is connected to the inverter.

Even if the inverter is turned off. It will damage the remote PCB inside if the cable is short circuited during cutting.

2.5.11 Audible Alarm

Table 2.5.9 OIS Series Audible Alarm Spec

Battery Voltage Low	Inverter green LED lit, and the buzzer beeps 0.5s every 5s.
Battery Voltage High	Inverter green LED lit, and the buzzer beeps 0.5s every 1s and Fault after 60s.
Invert Mode Over-Load	(1) 110% < load < 125% ($\pm 10\%$), No audible alarm in 14 minutes, Beeps 0.5s every 1s in 15 th minute and Fault after 15 minutes; (2) 125% < load < 150% ($\pm 10\%$), Beeps 0.5s every 1s and Fault after 60s; (3) Load > 150% ($\pm 10\%$), Beeps 0.5s every 1s and Fault after 20s;
Over Temperature	Heatsink temp. $\geq 105^{\circ}\text{C}$, Over temp red LED Lighting, beeps 0.5s every 1s;

2.5.12 FAN Operation

For 1-3KW, there is one multiple controlled DC fan which starts to work according to the following logic. For 4-6KW 48V, there is two multiple controlled DC fan. For 6KW 24V/4KW 12V, there is one DC fan and one AC fan. The DC fan will work in the same way as the one on 1-3KW, while the AC fan will work once there is AC output from the inverter.

So when the inverter is in power saver mode, the AC fan will work from time to time in response to the pulse sent by the inverter in power saver mode.

The Operation of the DC fan at the DC terminal side is controlled by the following logic (Refer to Table 2.5.10):

Table 2.5.10 OIS Series Fan Operation Logic

Condition	Enter condition	Leave condition	Speed
HEAT SINK TEMPERATURE	$T \leq 60^{\circ}\text{C}$	$T > 65^{\circ}\text{C}$	OFF
	$65^{\circ}\text{C} \leq T < 85^{\circ}\text{C}$	$T \leq 60^{\circ}\text{C} / T \geq 85^{\circ}\text{C}$	50%
	$T > 85^{\circ}\text{C}$	$T \leq 80^{\circ}\text{C}$	100%
CHARGER CURRENT	$I \leq 15\%$	$I \geq 20\%$	OFF
	$20\% < I \leq 50\%$	$I \leq 15\% / I \geq 50\%$	50%
	$I > 50\%$	$I \leq 40\%$	100%
LOAD% (INV MODE)	Load < 30%	Load $\geq 30\%$	OFF
	$30\% \leq \text{Load} < 50\%$	Load $\leq 20\% / \text{Load} \geq 50\%$	50%
	Load $\geq 50\%$	Load $\leq 40\%$	100%

Allow at least 30CM of clearance around the inverter for air flow. Make sure that the air can circulate freely around the unit.

Variable speed fan operation is required in invert and charge mode. This is to be implemented in such a way as to ensure high reliability and safe unit and component operating temperatures in an operating ambient temperature up to 50°C .

- Speed to be controlled in a smooth manner as a function of internal temperature and/or current.
- Fan should not start/stop suddenly.
- Fan should run at minimum speed needed to cool unit.
- Fan noise level target <60db at a distance of 1m.

2.5.13 Other features

Battery Temperature Sensing

Applying the proper charge voltage is critical for achieving optimum battery performance and longevity. The ideal charge voltage required by batteries changes with battery temperature.

The battery temperature sensor allows the charge controller to continuously adjust charge voltage based on actual battery temperature.

Temperature compensation of charge voltage assures that the battery receives the proper charge voltage as battery temperature varies.

The entire line is equipped with Battery Temperature Sensing for increased charging precision.

It sends precise information to the charger, which automatically adjusts voltage to help ensure full battery charge depending on the ambient temperature of your battery installation.

When the battery voltage is over 40°C(104°F), it will reduce the charging voltage by 0.1Vdc with every degree of temperature rise.

We recommend that you install Battery Temperature Sensors on all banks to protect your batteries and to provide optimal charging of each bank.

The battery temperature sensor mounts on the side of a battery.

The specification is as below

Inverter Condition	Temp on BST	Operation
Charger Mode	$BTS \geq 122^{\circ}F$	Automatically turns off charger
	$BTS \leq 104^{\circ}F$	Automatically turns on charger
Inverter Mode	$104^{\circ}F \leq BTS \leq 122^{\circ}F$	Increases the low voltage shut down point by 0.5Vdc
	$BTS \geq 122^{\circ}F$	Over Temp Fault

A Battery Temperature Sensor has been provided as a separate accessory. It comes with 32.8'/10m cable.

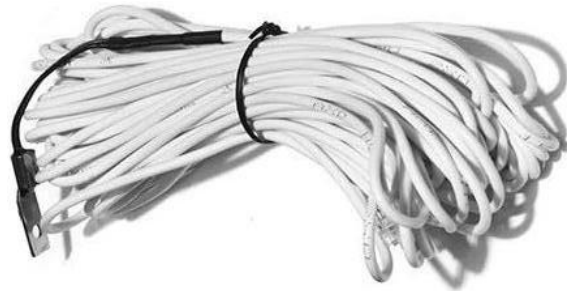

Battery voltage recover start

After low battery voltage shut off (10V for 12V model/20V for 24V model/40V for 48V model), the inverter is able to restore operation after the battery voltage recovers to 13Vdc/26Vdc/52Vdc (with power switch still in the “On” position). This function helps to save the users extra labor to reactivate the inverter when the low battery voltage returns to an acceptable range in the renewable energy systems. The built in battery charger will automatically reactivate as soon as city/generator ac has been stable for 15 seconds.



WARNING

Never leave the loads unattended, some loads (like a Heater) may cause accident in such cases.

It is better to shut everything down after low voltage trip than to leave your load on, due to the risk of fire.

Auto Gen Start

The inverter can be customized to start up a generator when battery voltage goes low.

When the inverter goes to low battery alarm, it can send a signal to start a generator, and turn the generator off after battery charging is finished. (Generator must have auto start function.)

The auto gen start feature will only work with generators designed to work with this feature. There is an open/close relay that will short circuit the positive and negative cable from a generator. The input DC voltage can vary, but the Max current the relay can carry is 16Amp.

Conformal Coating

The entire line of inverters have been processed with a conformal coating on the PCB, making it water, rust, and dust resistant.

While these units are designed to withstand corrosion from the salty air, they are not splash proof

3 Installation

3.1 Location

Follow all the local regulations to install the inverter.

Please install the equipment in a location that is Dry, Clean, Cool and that has good ventilation.

Working temperature: - 10°C - 40°C

Storage temperature: - 40 - 70°C

Relative Humidity: 0% - 95%, non-condensing

Cooling: Forced air

3.2 DC Wiring recommendation

It is suggested the battery bank be kept as close as possible to the inverter. The following table is a suggested wiring option for 3 meter DC cable.

Please find the following minimum wire size. In case of DC cable longer than 3m, please increase the cross section of cable to reduce the loss.

Power	DC Input voltage	Wire Gage
1KW	12V	AWG 1/0
1KW	24V	AWG 4
1.5KW	12V	AWG 1/0
1.5KW	24V	AWG 4
2KW	12V	AWG 1/0
2KW	24V	AWG 1/0
2KW	48V	AWG 4
3KW	12V	AWG 4/0
3KW	24V	AWG 1/0
3KW	48V	AWG 4
4KW	24V	AWG 1/0
4KW	48V	AWG 1/0
5KW	24V	AWG 4/0
5KW	48V	AWG 1/0
6KW	24V	AWG 4/0
6KW	48V	AWG 1/0

Please follow the above minimum wire size requirement.

One cable is always best, but if there is a problem obtaining the recommended size or larger cable, multiple smaller cables will work. Performance of any product can be improved by thicker cable and shorter runs, so if in doubt round up and keep the length as short as possible.

3.3 AC Wiring

We recommend using 10 to 6Awg wire to connect to the AC terminal block.

When in AC mode the AC input power will supply both the loads and AC charger, a thicker wire gauge for AC Input is required. Please consult a qualified electrician about the specific wire gauge required in terms of wire material and inverter power.

There are 3 different ways of connecting to the terminal block depending on the model. All the wirings are CE compliant, Call our tech support if you are not sure about how to wire any part of your inverter.

<p>Wiring Option 1</p> <p>230V single phase/120V single phase Input: Hot line+Neutral+Ground Output: Hot line+Neutral+Ground</p>	
<p>Wiring Option 2</p> <p>230V split phase Input: Hot line+ Hot line +Ground Output: Hot line+ Hot line +Neutral</p>	
<p>Wiring Option 3</p> <p>230V split phase Input: Hot line+ Hot line +Ground Output: Hot line +Neutral</p> <p>Remark: In such cases, each output hotline can only carry a max of half the rated capacity.</p>	



WARNING

For split phase models, AC input neutral is not required in wiring. Never Connect Input Neutral to Output Neutral. Damage will result which is not covered under warranty.



WARNING

The output voltage of this unit must never be connected in its input AC terminal, overload or damage may result.

Always switch on the inverter before plugging in any appliance.

3.4 Grounding

Connect an AWG 8 gauge or greater copper wire between the grounding terminal on the inverter and the earth grounding system or the vehicle chassis.

3.4.1 Automatic Neutral-to-Ground Connection

All single-phase 120Vac inverters are equipped with an automatic neutral-to-ground switch.

These inverters use an internal relay that automatically connects the AC neutral output to the vehicle/ship's safety ground in inverter mode and cuts off when it is connected to a qualified external AC power source. This design avoids the simultaneous existence of two neutral-to-ground connections, thereby avoiding the risk of shock hazard between the vehicle/boat's neutral and the external AC source's neutral.

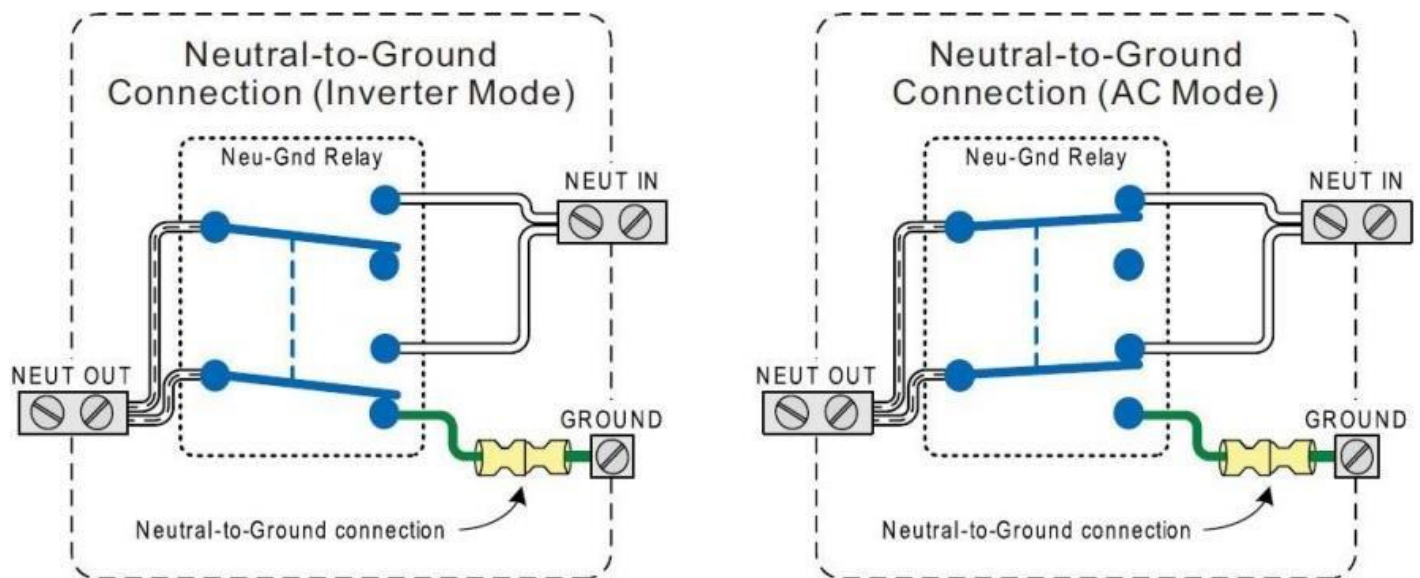

3.4.2 Disabling the Automatic Neutral-to-Ground Connection

In some installations, this function must be disabled.

In order to accommodate to these situations, the automatic neutral-to-ground system can be defeated, so the neutral will not be bonded in any operating mode.

If you are not sure whether you must disable this function, please refer to the local code requirements.

There is a section of green wire with insulated connector at the left side of the AC terminal block. The insulated connector connects the neutral wire and the ground wire inside the inverter during inverting.

Pull two ends of the insulated connector apart to separate the green wire; this will prevent the neutral and ground wires from being connected to the inside of the inverter.

If possible, please use tape to insulate the disconnected ends, separate the ends from each other and push back out of the way. Typically when connecting to the house panel (after disconnecting city power from it), it is when you want to disconnect this connection as the house panel already has the neutral to ground bond. Normally in a standalone system or in a vehicle, you need to maintain this connection.

3.5 Install Flange

<p style="text-align: center;">Frame 1</p>	<p>1000W to 1500W Models</p>
<p style="text-align: center;">Frame 2</p>	<p>2000W to 4000W Models</p>
<p style="text-align: center;">Frame 3</p>	<p>5000W to 6000W Model</p>
<p style="text-align: right;">Side View For LFP</p>	

4

Troubleshooting Guide

Troubleshooting contains information about how to troubleshoot possible error conditions while using the LFP Series Inverter & Charger.

The following chart is designed to help you quickly pinpoint the most common inverter failures.

Indicator and Buzzer For LFP

Status	Item	Indicator on top cover							LED on Remote Swit			Buzzer
		SHOR E POWE R ON	INVERT ER ON	FAST CHG	FLOAT CHG	OVER TEMP TRIP	OVER LOAD TRIP	POWER SAVER ON	BATT CHG	INVERTE R	Alarm	
Line Mode	CC	√	×	√	×	×	×	×	√	×	×	×
	CV	√	×	√, blink	×	×	×	×	√	×	×	×
	Float	√	×	×	√	×	×	×	√	×	×	×
	Standby	√	×	×	×	×	×	×	×	×	×	×
Inverter Mode	Inverter On	×	√	×	×	×	×	×	×	√	×	×
	Power Saver	×	×	×	×	×	×	√	×	×	×	×
Inverter Mode	Battery Low	×	√	×	×	×	×	×	×	√	√	Beep 0.5s every 5s
	Battery High	×	√	×	×	×	×	×	×	√	√	Beep 0.5s every 1s
	Overload On Invert Mode	×	√	×	×	×	√	×	×	√	√	Refer to “Audible alarm”
	Over-Temp On Invert Mode	×	√	×	×	√	×	×	×	√	√	Beep 0.5s every 1s
	Over-Temp On Line Mode	√	×	√	×	√	×	×	√	×	√	Beep 0.5s every 1s
	Over Charge	√	×	√	×	×	×	×	√	×	√	Beep 0.5s every 1s
Fault Mode	Fan Lock	×	×	×	×	×	×	×	×	×	×	Beep continuous
	Battery High	×	√	×	×	×	×	×	×	√	×	Beep continuous
	Inverter Mode Overload	×	×	×	×	×	√	×	×	×	×	Beep continuous
	Output Short	×	×	×	×	×	√	×	×	×	√	Beep continuous
	Over-Temp	×	×	×	×	√	×	×	×	×	×	Beep continuous
	Over Charge	×	×	√	×	×	×	×	√	×	×	Beep continuous
	Back Feed Short	×	×	×	×	×	×	×	×	×	×	Beep continuous

Indicator and Buzzer For LFP

Status	Item	LED Indicators on top cover								LEDs on Remote Switch			Buzzer	
		POWER SAVER	OVER LOAD	OVER TEMP	UNIT ALARM	FLOAT CHG	FAST CHD	INVERTE R MODE	LINE MODE	BATT CHG	INVER TER	Alarm		
		1	2	3	4	5	6	7	8	1	2	3		
Line Mode	CC						√		√	√				
	CV						√, Flash		√	√				
	Float					√			√	√				
	Standby								√					
Inverter Mode	Inverter On							√			√			
	Power Saver	√												
Inverter Mode	Battery Low				√			√			√	√	Beep 0.5s every 5s	
	Battery High				√			√			√	√	Beep 0.5s every 1s	
	Overload On Invert Mode		√		√			√			√	√	Refer to "Audible alarm"	
	Over-Temp On Invert Mode			√	√			√			√	√	Beep 0.5s every 1s	
	Over-Temp On Line Mode			√	√			√		√	√		√	Beep 0.5s every 1s
	Over Charge				√			√		√	√		√	Beep 0.5s every 1s
Fault Mode	Fan Lock												Beep continuous	
	Battery High							√			√		Beep continuous	
	Inverter Mode Overload		√										Beep continuous	
	Output Short												Beep continuous	
	Over-Temp			√									Beep continuous	
	Over Charge							√			√		Beep continuous	
	Back Feed Short												Beep continuous	

***The reason for the noise from transformer and/or case**

Symptom	Possible Cause	Recommended Solution
Inverter will not turn on during initial power up.	Batteries are not connected, loose battery-side connections. Low battery voltage.	Check the batteries and cable connections. Check DC fuse and breaker. Charge the battery.
No AC output voltage and no indicator lights ON.	Inverter has been manually transitioned to OFF mode.	Press the switch to Power saver on or Power saver off position.
AC output voltage is low and the inverter turns loads OFF in a short time.	Low battery.	Check the condition of the batteries and recharge if possible.
Charger is inoperative and unit will not accept AC.	AC voltage has dropped out-of-tolerance	Check the AC voltage for proper voltage and frequency.
Charger is supplying a lower charge rate.	Charger controls are improperly set. Low AC input voltage. Loose battery or AC input connections.	Refer to the section on adjusting the "Charger Rate". Source qualified AC power.. Check all DC /AC connections.
Charger turns OFF while charging from a generator.	High AC input voltages from the generator.	Load the generator down with a heavy load. Turn the generator output voltage down.
Sensitive loads turn off temporarily when transferring between grid and inverting.	Inverter's Low voltage trip voltage may be too low to sustain certain loads.	Choose narrow AC voltage in the DIP switch, or Install a UPS if possible.
Noise from Transformer/case*	Applying specific loads such as hair drier	Remove the loads

When in inverter mode and the transformer and/or case of the inverter sometimes may vibrate and make noise.

The noise may come from transformer.

According to the characteristics of our inverter, there is one type of load which will most likely to cause rattles of transformer, that is a half-wave load, load that uses only a half cycle of the power(see figure 1). This tends to cause imbalance of magnetic field of transformer, reducing its rated working freq from 20KHz to, say, maybe 15KHz (it varies according to different loads). This way, the freq of noise falls exactly into the range (200Hz-20KHz) that human ear can sense.

The most common load of such kind is hair drier.

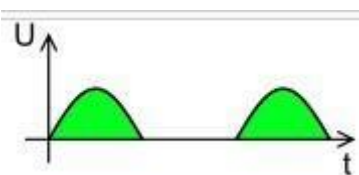

Figure 1

If the noise comes from case.

Normally when loaded with inductive loads, the magnetic field generated by transformer keeps attracting or releasing the steel case at a specific freq, this may also cause noise.

Reducing the load power or using an inverter with bigger capacity will normally solve this problem.

The noise will not do any harm to the inverter or the loads.

5 Warranty

We offer a 1 year limited warranty.

The following cases are not covered under warranty. 1 DC polarity reverse.

The inverter is designed without DC polarity reverse protection. A polarity reverse may severely damage the inverter.

Wrong AC wiring

Operating in a wet environment.

Operating with an undersized generator or generator with unqualified wave form

Appendix 1

Inverter & AC Charger

Electrical Specifications

Model		1KW	1.5KW	2KW	3KW	4KW	5KW	6KW
Inverter Output	Continuous Output Power	1000W	1500W	2000W	3000W	4000W	5000W	6000W
	Surge Rating(20s)	3000W	4500W	6000W	9000W	12000W	15000W	18000W
	Capable of Starting Electric Motor	1HP	1.5HP	2HP	3HP	4HP	5HP	6HP
	Output Waveform	Pure Sine wave/Same as input(Bypass mode)						
	Nominal Efficiency	>88%(Peak)						
	Line Mode Efficiency	>95%						
	Power Factor	0.9-1.0						
	Nominal Output Voltage rms	100-110-120Vac / 220-230-240Vac						
	Output Voltage Regulation	±10% RMS						
	Output Frequency	50/60Hz ± 0.3Hz						
	Short Circuit Protection	Yes, Current Limit Function (Fault after 1sec)						
	Typical transfer Time	10ms(Max)						
THD	< 10%							
DC Input	Nominal Input Voltage	12.0Vdc (*2 for 24Vdc, *4 for 48Vdc)						
	Minimum Start Voltage	10.0Vdc						
	Low Battery Alarm	10.5Vdc / 11.0Vdc						
	Low Battery Trip	10.0Vdc / 10.5Vdc						
	High Voltage Alarm & Fault	16.0Vdc						
	High DC Input Recovery	15.5Vdc						
	Low Battery voltage recover	13.0Vdc						
	Idle Consumption-Search Mode	< 25 W when Power Saver On						
Input Voltage Range	Input Voltage Range	Narrow: 100~135VAC / 194~243VAC; Wide: 90~135VAC / 164~243VAC;						
	Input Frequency Range	Narrow: 47-55±0.3Hz for 50Hz, 57-65±0.3Hz for 60Hz Wide:43±0.3Hz plus for 50Hz/60Hz						
	Output Voltage	Depends on battery type						
	Charger Breaker Rating (230Vac)	10A	10A	10A	20A	20A	30A	30A
	Charger Breaker Rating (120Vac)	10A	20A	20A	30A	40A	N/A	N/A
	Over Charge Protection Shutdown	15.7V for 12Vdc (*2 for 24Vdc, *4 for 48Vdc)						

Charge	Battery type	Fast Vdc				Float Vdc			
	Gel U.S.A	14.0				13.7			
	A.G.M 1	14.1				13.4			
	Lithium	13.8				13.6			
	Sealed Lead Acid	14.4				13.6			
	Gel Euro	14.4				13.8			
	Open Lead Acid	14.8				13.3			
	LiFePO4	14.0				13.8			
	De-sulphation	15.5 for 4hrs							
	Classic LFP	13.6				13.5			
	Remote Control	Yes. Optional							
Bypass & Protection	Input Voltage Waveform	Sine wave (Grid or Generator)							
	Nominal Voltage	120Vac				230Vac			
	Low Voltage Trip	80V/90V±4%				184V/154V±4%			
	Low Voltage re engage	90V/100V±4 %				194V/164V±4%			
	High Voltage Trip	140V±4%				253V±4%			
	High Voltage re engage	135V±4%				243V±4%			
	Max Input AC Voltage	150VAC				270VAC			
	Nominal Input Frequency	50Hz or 60Hz (Auto detect)							
	Low Freq Trip	Narrow: 47±0.3Hz for 50Hz, 57±0.3Hz for 60Hz Wide:40±0.3Hz for 50Hz/60Hz							
	Low Freq re engage	Narrow: 48±0.3Hz for 50Hz, 58±0.3Hz for 60Hz Wide:45±0.3Hz for 50Hz/60Hz							
	High Freq Trip	Narrow: 55±0.3Hz for 50Hz, 65±0.3Hz for 60Hz Wide: No up limit for 50Hz/60Hz							
	High Freq re engage	Narrow: 54±0.3Hz for 50Hz, 64±0.3Hz for 60Hz Wide: No up limit for 50Hz/60Hz							
	Baypass Breaker Rating (230Vac)	10A	15A	20A	30A	30A	40A	40A	
	Baypass Breaker Rating (120Vac)	20A	20A	30A	30A	40A	N/A	N/A	
Output Short circuit protection	Circuit breaker								
Mechanical Specification	Mounting	Wall mount							
	Inverter Dimensions(L*W*H)	362*242*198mm		505*242*198mm			597*242*198mm		
	Inverter Weight	16KG	17KG	20KG	24KG	35KG	45KG	45KG	
	Shipping Dimensions(L*W*H)	520x320x310mm		670x320x310mm			760x320x310mm		
	Shipping Weight	18KG	19KG	22KG	26KG	37KG	47KG	47KG	
	Display	Status LEDs							
	Standard Warranty	1 Year							

Appendix 2 - Installation Diagram

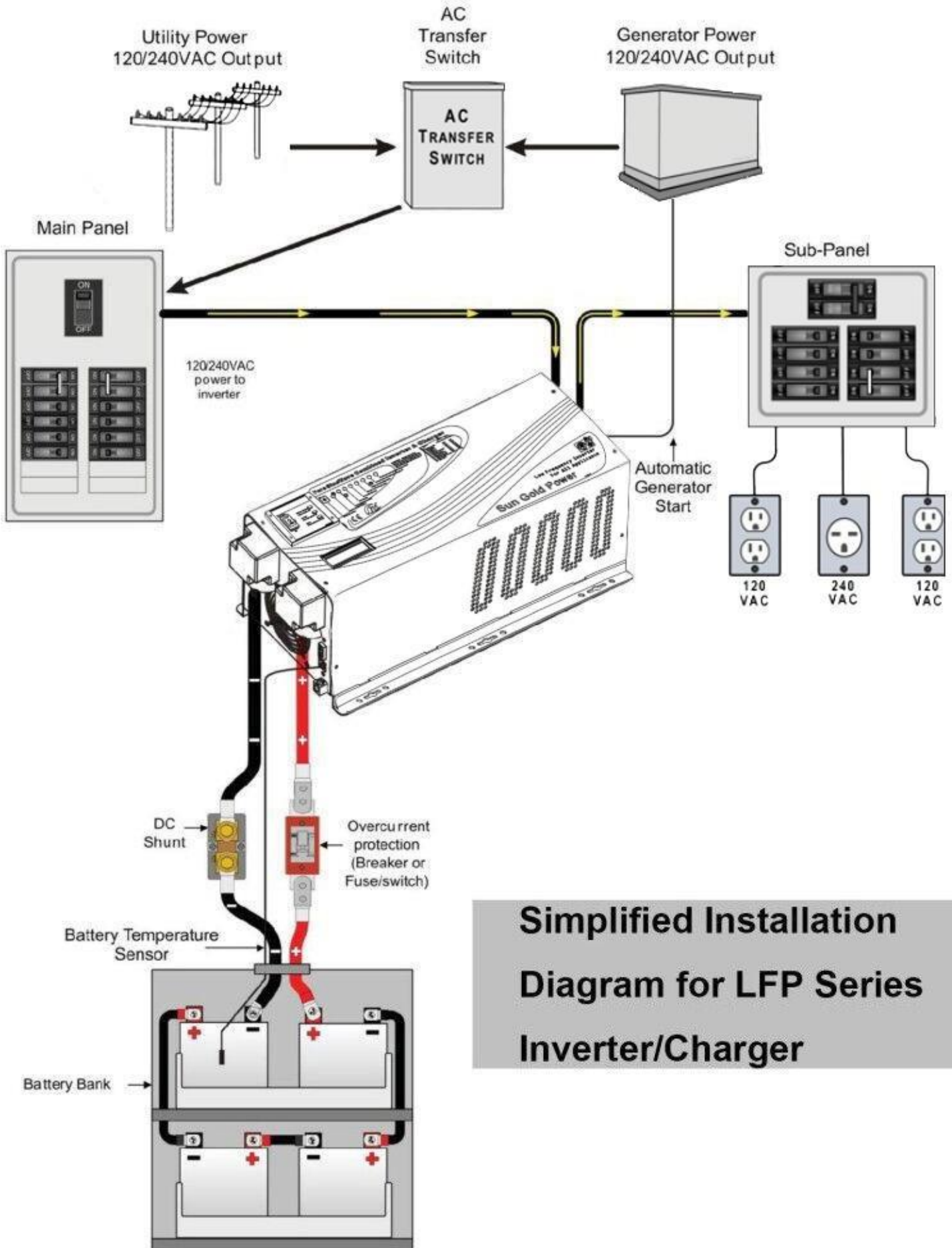

**Simplified Installation
Diagram for LFP Series
Inverter/Charger**



Sun Gold Power Co.,Ltd

Email: sales@sungoldpower.com

TEL: 812-727-7788

Add: SUITE 500-343 WPORT BEACH CA 92660,USA