

User Manual

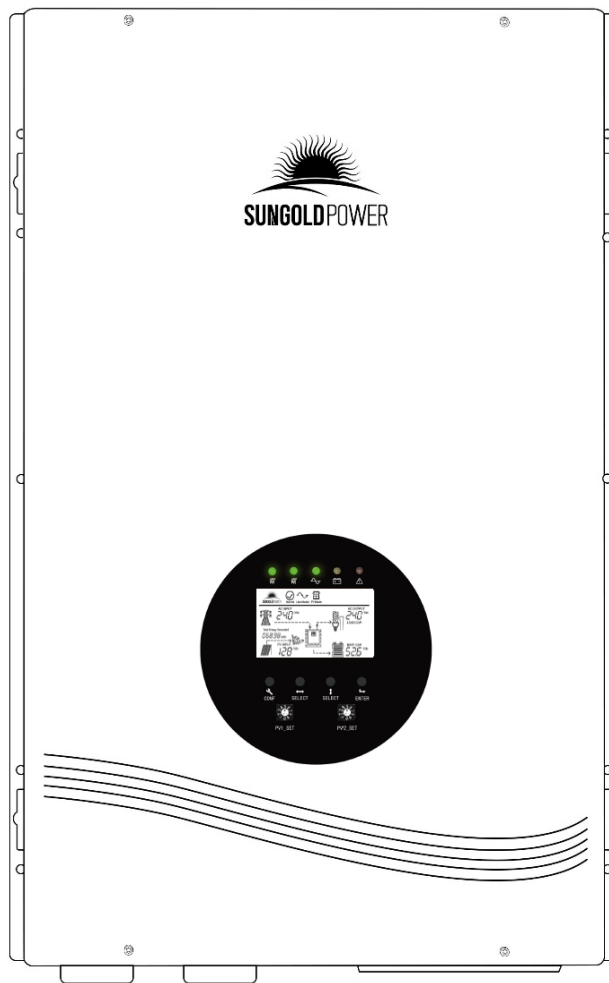

8K-12KW LFPV Hybrid Solar Inverter

CONTENTS

ABOUT THIS MANUAL	1
Purpose.....	1
Scope.....	1
IMPORTANT SAFETY INSTRUCTIONS	1
General Precautions	1
Personal Precautions	2
INSTALLATION	3
Unpacking and Inspection	3
Basic Configuration	3
Mounting the Unit	4
Batteries.....	4
Battery Cable Size	5
DC Disconnect and Over-Current Protection	5
Battery Cable Connection	5
AC Cable Size.....	6
AC Connections	6
PV Connection	7
Generator start signal.....	7
Machine panel introduction	8
OPERATION	9
LCD Panel and Configuration Switch	9
Setting Indicators	10
LCD display meaning.....	13
Operating Indicators.....	14
SPECIFICATIONS	16
APPENDIX A	20
How to Select and Configure PV Panels.....	20
APPENDIX B (Wi-Fi Plug Pro)	21
Quick Installation Guideline.....	21
DISPOSAL	24

ABOUT THIS MANUAL

Purpose

The purpose of this manual is to provide explanations and procedures for installing, operating and troubleshooting for the unit. This manual should be read carefully before installations and operations. Please retain this manual for future reference.

Scope

This document defines the functional requirements of the unit, intended for worldwide use in electronic processing equipment. All manuals are applicable under all operating conditions when installed in the End Use system, unless otherwise stated.

IMPORTANT SAFETY INSTRUCTIONS



WARNING: This chapter contains important safety and operating instructions. Read and keep this User Guide for future reference.

General Precautions

1. Before using the unit, read all instructions and cautionary markings on:
(1) The unit (2) the batteries (3) all appropriate sections of this manual.
2. **CAUTION** --To reduce risk of injury, charge only deep-cycle lead acid type rechargeable batteries or LiFePO4 batteries. Other types of batteries may burst, causing personal injury and damage.
3. Do not expose the unit to rain, snow or liquids of any type. The unit is designed for indoor use only. Protect the unit from splashing if used in vehicle applications.
4. Do not disassemble the unit. Take it to a qualified service center when service or repair is required. Incorrect re-assembly may result in a risk of electric shock or fire.
5. To reduce risk of electric shock, disconnect all wiring before attempting any maintenance or cleaning. Turning off the unit will not reduce this risk.
6. **CAUTION** --Battery are not already installed by the supplier only a qualified professional (e.g. service person) may install the Inverter.
7. **WARNING: WORKING IN VICINITY OF A LEAD ACID BATTERY IS DANGEROUS.**
BATTERIES GENERATE EXPLOSIVE GASES DURING NORMAL OPERATION. Provide ventilation to outdoors from the battery compartment. The battery enclosure should be designed to prevent accumulation and concentration of hydrogen gas in "pockets" at the top of the compartment. Vent the battery compartment from the highest point. A sloped lid can also be used to direct the flow to the vent opening location.
8. **NEVER** charge a frozen battery.
9. No terminals or lugs are required for hook-up of the AC wiring. AC wiring must be no less than 10 AWG gauge copper wire details refer to table 2. Battery cables must be rated for 35mm or higher and should be no less than table 1. Crimped and sealed copper ring terminal lugs with a HRNB38-8 hole should be used to connect the battery cables to the DC terminals of the unit. Soldered cable lugs are also acceptable.
10. Be extra cautious when working with metal tools on, or around batteries. The potential exists to drop a

tool and short-circuit the batteries or other electrical parts resulting in sparks that could cause an explosion.

11. No AC or DC disconnects are provided as an integral part of this unit. Both AC and DC disconnects must be provided as part of the system installation. See INSTALLATION section of this manual.
12. Fuses are provided as the over current protection of the battery supply.
13. When PV module or panel is exposed to light, it starts to supply high DC voltage, be sure to turn off DC switch before commencing the maintenance, and make sure the cables from PV panel are properly sealed after disconnection.
14. **GROUNDING INSTRUCTIONS** -This battery charger should be connected to a grounded permanent wiring system. For most installations, the Ground Lug should be bonded to the grounding system at one (and only one point) in the system. All installations should comply with all national and local codes and ordinances.
15. **AVOID** AC output short-circuit; avoid DC input short-circuit and do not connect the mains while DC input short-circuit
16. **Warning:** The maintenance information is only for service persons, if the product is used in a manner which is not covered by the scope of warranty, the protection provided by the product may be impaired.

Personal Precautions

1. Someone should be within range of your voice to come to your aid when you work near batteries.
2. Have plenty of fresh water and soap nearby in case battery acid contacts skin, clothing, or eyes.
3. Wear complete eye protection and clothing protection. Avoid touching eyes while working near batteries. Wash your hands when done.
4. If battery acid contacts skin or clothing, wash immediately with soap and water. If acid enters eyes, immediately flood eyes with running cool water for at least 15 minutes and get medical attention immediately.
5. Baking soda neutralizes lead acid battery electrolyte. Keep a supply on hand in the area of the batteries.
6. NEVER smoke or allow a spark or flame in vicinity of a battery or generator.
7. Be extra cautious when working with metal tools on, and around batteries. Potential exists to short-circuit the batteries or other electrical parts which may result in a spark which could cause an explosion.
8. Remove personal metal items such as rings, bracelets, necklaces, and watches when working with battery. Battery can produce short-circuit current high enough to weld a ring, or the like, to metal causing severe burns.
9. If a remote or automatic generator start system is used, disable the automatic starting circuit and/or disconnect the generator from its starting battery while servicing to prevent accidental starting during servicing.

INSTALLATION

Unpacking and Inspection

Carefully unpack the inverter/charger from its shipping carton.

Verify all of items list below are present. Please call customer service if any items are missing.

• The unit

• 1 user's manual

Basic Configuration

LFPV Series hybrid Inverter is designed to serve as a backup power supply for AC loads. The input power of LFPV Series hybrid Inverter comes from PV system and AC grid which not only supply power to AC loads but also charge the battery bank when the power from AC grid or AC generator is present (also known as Line Mode). In the event of AC grid (or AC generator) outage, the AC loads can be alternatively powered by PV system (if the illumination is sufficient) and battery bank.

The following illustrations show basic applications for LFPV Series hybrid Inverter.

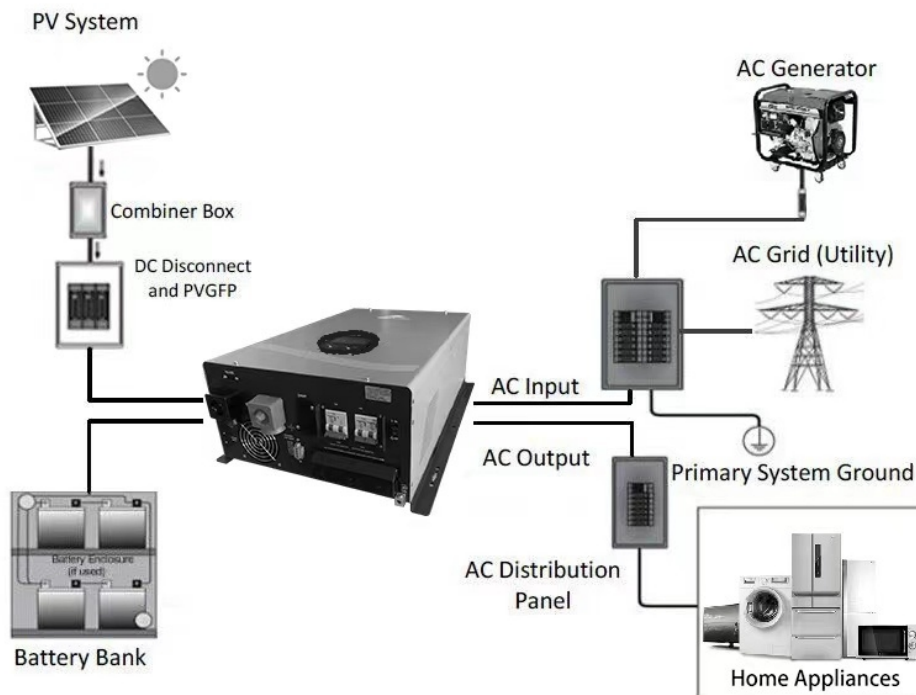

Figure 1. Typical Application of LFPV series hybrid Inverter

Note: Appliances like Air conditioner needs at least 3 minutes to restart in case of a power shortage occurs in a way that the power turns off then back on again rapidly (time is required to balance the refrigerant gas in inside circuit); so in order to protect your Air conditioner, please consult the Air conditioner manufacturer whether they have already provided time delay function before installing. Otherwise, Inverter will trig overload fault and shut off its output to protect your appliance but sometimes it is not enough and your Air conditioner can be damaged internally beyond repair.

Mounting the Unit

Consider the following points before selecting where to install:

1 Do not mount the inverter on flammable construction

Materials.

2 Mount on a solid surface

3 Install this inverter at eye level in order to allow the LCD display to be read at all times.

4 The ambient temperature should be between 0°C and 50°C to ensure optimal operation.

5 The recommended installation position is to be adhered to the wall vertically.

6 Be sure to keep other objects and surfaces as shown in the right diagram to guarantee sufficient heat dissipation and to have enough space for removing wires.

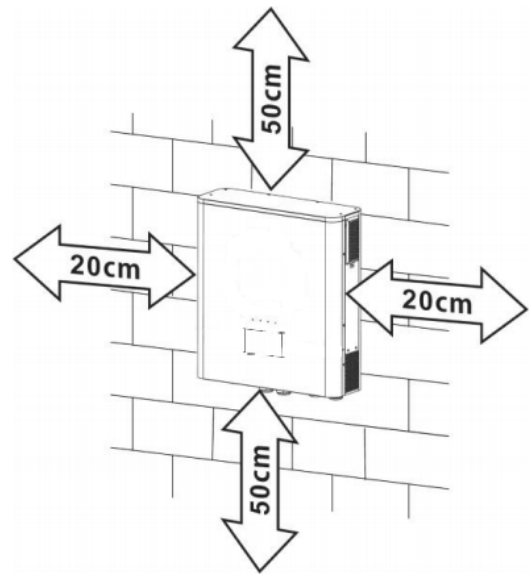

SUITABLE FOR MOUNTING ON CONCRETE OR OTHER NON-COMBUSTIBLE SURFACE ONLY

Batteries

The unit support 48vlot battery bank. Please wire battery correctly. Before proceeding, ensure you have appropriate size batteries for this inverter. The unit can use flooded lead-acid, sealed GEL/AGM lead-acid batteries or LiFePO4 batteries so ensure that your batteries are in one of these categories. LFPV inverter with built-in MPPT solar controller, for the battery and solar panel connection please refer to figure 2 and figure3. if with the built-in 48VDC MPPT 60A solar charge controller, then please configure solar panels more than 3500W, otherwise it can not reach the maximum charge current.

Note: if you are using a gel battery or a deep cycle battery, please do not use ordinary lead-acid batteries for use in solar energy systems. This is likely to damage the lead acid battery or to reach the desired effect.

The battery must be wired to match with the DC input voltage. Recommend to use battery capacity more than 200AH.

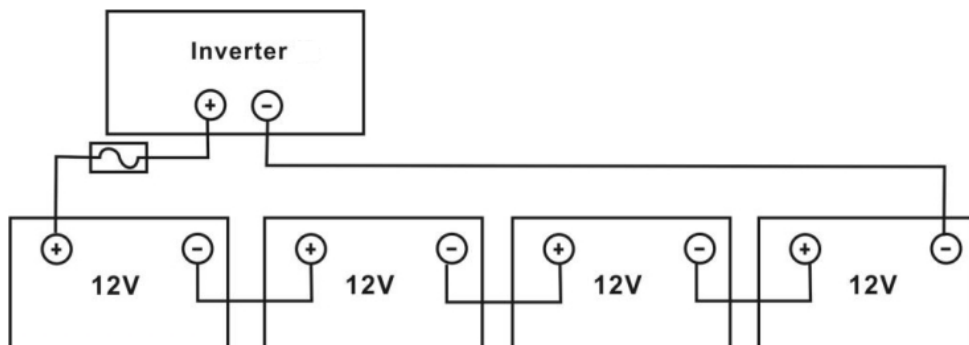

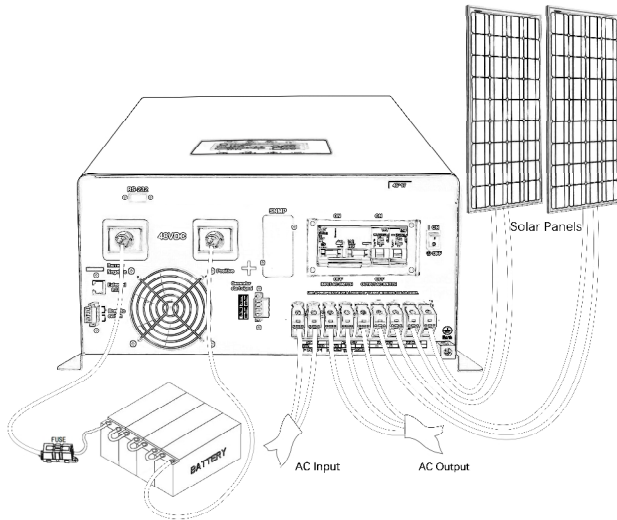

Figure 2. Dual MPPT 120A charging system

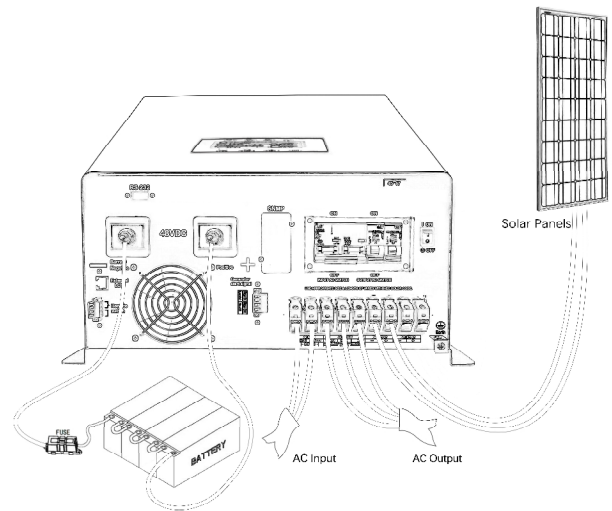

Figure 3. Single MPPT 60A charging system

Battery Cable Size

Below table 1 you can find information for recommended battery cable and terminal.

Table 1. Recommended battery cable and terminal size

Model Number	DC Voltage	Typical Amperage	Battery Capacity	1~3 m one-way	0.5 m one-way	Cable Terminal
8KW	48V	192A	200AH	50mm ²	35mm ²	RNB50-8/RNB38-8
10KW	48V	240A	200AH	75mm ²	50mm ²	RNB80-8/RNB60-8
12KW	48V	288A	200AH	75mm ²	50mm ²	RNB80-8/RNB60-8

DC Disconnect and Over-Current Protection

For safety and to comply with regulations, battery over-current protection and disconnect devices are required. Fuses and disconnects must be sized to protect the DC cable size used, and must be rated for DC operation. Do not use devices rated only for AC service – they will not function properly.

Note: that some installation requirements may not require a disconnect device, although over-current protection is still required.

Battery Cable Connection

Observe Battery Polarity! Place the ring terminal of DC cable over the bolt and directly against the unit’s battery terminal. Tighten the M8 screw with 6-10 Nm. Do not place anything between the flat part of the Backup System terminal and the battery cable ring terminal or overheating may occur.

DO NOT APPLY ANY TYPE OF ANTI-OXIDANT PASTE TO TERMINALS UNTIL AFTER THE BATTERY CABLE WIRING IS TORQUED!!

WARNING: Shock Hazard

Installation must be performed with care for the high battery voltage in series.



Caution!! Do NOT place anything between battery cable ring terminals and terminals on the inverter. The terminal screw is not designed to carry current.

Apply Anti-oxidant paste to terminals AFTER terminals have been screwed.

Verify that cable lugs are flush with the battery terminals. Tighten battery cables to terminals (6-10 Nm).

Before making the final DC connection or closing DC breaker/disconnect or, be sure Positive (+) must be connected to positive (+) and negative (-) must be connected to Negative (-).

AC Cable Size

Before wiring the input and output of inverter, refer to table 2 for minimum recommended cable size and torque value

Table 2. Recommended cable size and torque value for AC wire

Model Number	Typical Amperage	AC Input		AC Output		Torque value
		AWG	mm ²	AWG	mm ²	
8KW	60A	10AWG	6mm ²	10 AWG	6mm ²	2.0~2.5 Nm
10KW	70A	8AWG	10mm ²	10 AWG	6mm ²	2.0~2.5 Nm
12KW	80A	6AWG	16mm ²	8AWG	10mm ²	2.0~2.5 Nm

AC Connections

Installation should be done by a qualified electrician. Consult standards code for the proper wire sizes, connectors and conduit requirements.

On the left of rear chassis is the AC hardwire cover. Two three-station terminal block is provided to make the AC connections. The terminal block is used to hardwire the AC input, AC output, and ground. The National Electrical Code requires that an external disconnect switch be used in the AC input wiring circuit. The AC breakers in a sub panel will meet this requirement.

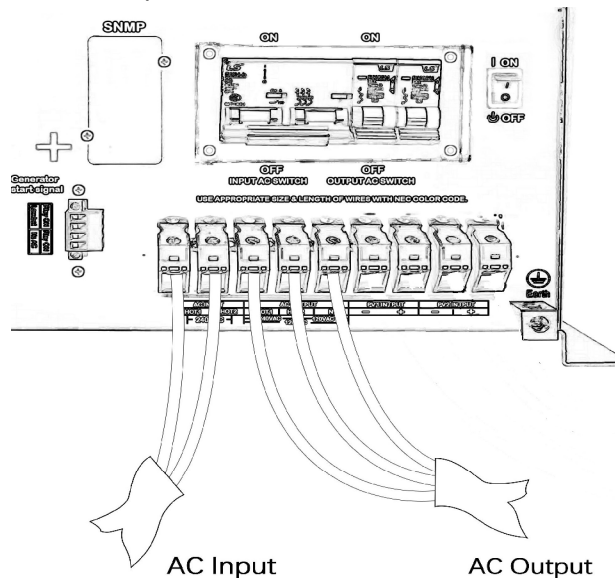

Figure 4. AC Cable Connect to unit

Step 1: Disconnect the unit from the battery by removing the battery cables. Turning off the unit before disconnect from the battery.

Step 2: Following the wiring guide located in the AC input wiring compartment as figure 5, connect the GND (green/yellow), HOT1 (brown), and HOT2 (red) wires from the AC input (utility, generator, etc) to the terminal block.



Caution!! Be sure that AC source is disconnected before attempting to hardwire it to the unit.

Step 3: Connect the AC Line output wiring to the terminal marked AC Line (output), following the wiring guide inside the compartment. Torque the wires into the terminal block.

Step 4: Lock the AC covers.

PV Connection

CAUTION: Before connecting to PV modules, please install separately a DC circuit breaker between inverter and PV modules.

WARNING! It's very important for system safety and efficient operation to use appropriate cable for PV module connection. To reduce risk of injury, please use the proper recommended cable size as below.

Table 3. Recommended cable size and torque value for PV wire

Use position of wire rod	Wire Size	Cable (mm ²)	Torque value (max)
Connection of PV to combiner box	12AWG	4mm ²	1.2~1.5 Nm
Connection from combiner box to Inverter	8AWG	10mm ²	2.0~2.5 Nm

WARNING: Because this inverter is non-isolated, only three types of PV modules are acceptable: single crystalline, poly crystalline with class A-rated and CIGS modules.

To avoid any malfunction, do not connect any PV modules with possible current leakage to the inverter. For example, grounded PV modules will cause current leakage to the inverter. When using CIGS modules, please be sure NO grounding.

CAUTION: It's requested to use PV junction box with surge protection. Otherwise, it will cause damage on inverter when lightning occurs on PV modules.

PV Module Selection:

When selecting proper PV modules, please be sure to consider below parameters:

1. Open circuit Voltage (Voc) of PV modules not exceeds max. PV array open circuit voltage of inverter.
2. Open circuit Voltage (Voc) of PV modules should be higher than min. battery voltage.

Table 4. MPPT input voltage range

INVERTER MODEL	LFPV8KW / LFPV10KW / LFPV12KW
Max. PV Array Open Circuit Voltage	155Vdc
PV Array MPPT Voltage Range	60Vdc~145Vdc

Refer to Appendix A for configuration information of PV panel.

Generator start signal

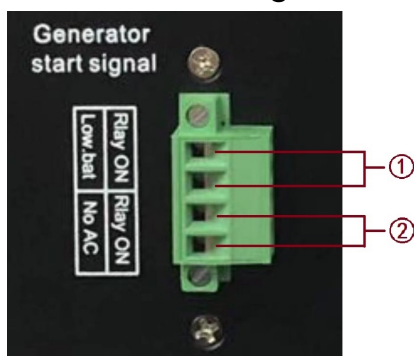

Two schemes can send signal to start the generator.

Either scheme is selectable by users to start the generator.

1. Start the generator while battery low.
2. Start the generator while mains power unavailable.

Machine panel introduction

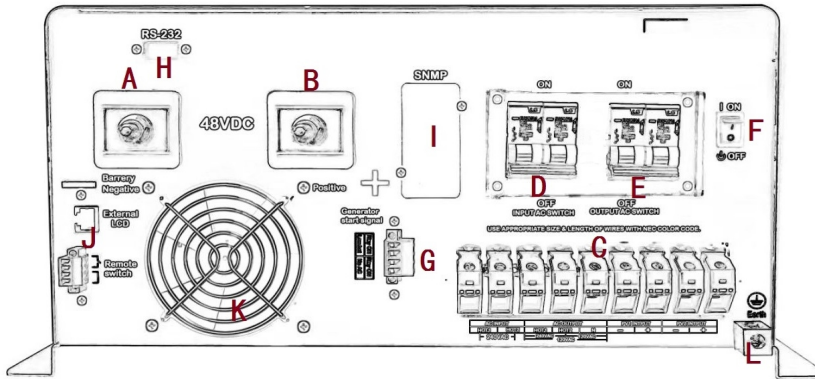

Figure 5. 8KW-12KW Front panel

Explain:

- A. Battery Positive
- B. Battery Negative
- C. Terminal block
- D. AC input switch
- E. AC output switch
- F. On / off switch
- G. Generator start signal
- H. RS-232 (Optional)
- I. SNMP interface (Optional)
- J. Remote switch and remote LCD (Optional)
- K. DC FAN
- L. Grounding terminal
- M. HOT1 Output socket
- N. AC FAN

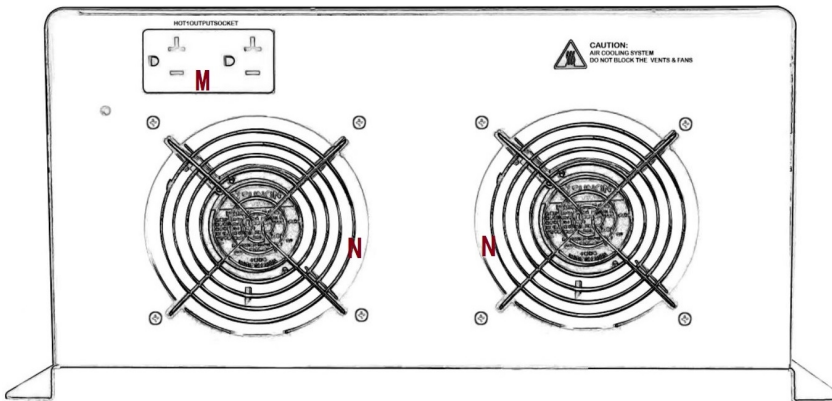

Figure 6. 8-12KW Back panel

OPERATION

LCD Panel and Configuration Switch

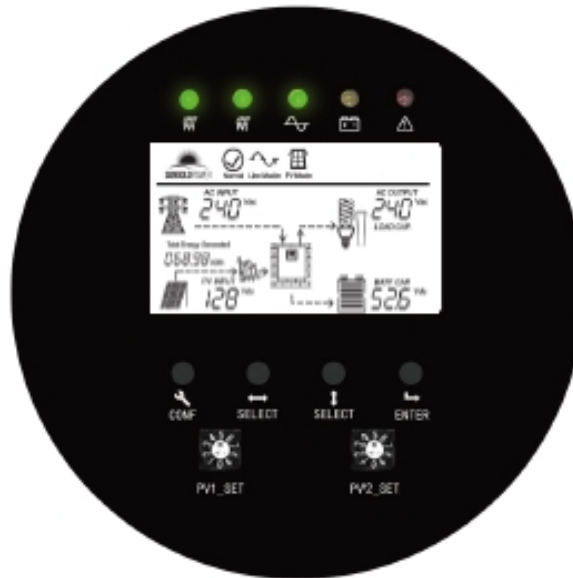

Table 5: configuration button function

Switch	Description
CONF	long press "1S" button to enter the setting interface
Left – Right SELECT	Left-right SELECT button can be used for selecting different contents(Voltage, frequency, charging current...)
Up – Down SELECT	Up – down SELECT button can be used for selecting parameter on the function setting mode
ENTER	Confirm, data save function
MPPT charging voltage selection switch	
PV1_SET	Set the charging voltage of MPPT1 through the selector switch
PV2_SET	Set the charging voltage of MPPT2 through the selector switch
LED Indicator	
LED	Description
PV1-LED	GREEN LED Lighting on PV1 normal
PV2-LED	GREEN LED Lighting on PV2 normal
AC-LED	GREEN LED lighting on AC Mode
Battery-LED	YELLOW LED lighting on Battery Inverter Mode
Alarm-LED	RED LED lighting on Fault

Setting Indicators

Table 6: MPPT configuration option(PV1_SET and PV2_SET)

Selector switch gear	Boost Voltage	Float Voltage	Battery type recommended
0	56.4V	54.8V	AGM1
1	56.8V	55.2V	AGM2
2	58.8V	58.0V	16 string LiFePO4 battery pack
3	58.0V	57.6V	16 string LiFePO4 battery pack
4	57.2V	56.4V	16 string LiFePO4 battery pack
5	55.2V	54.4V	15 string LiFePO4 battery pack
6	54.4V	54.0V	15 string LiFePO4 battery pack
7	53.6V	52.8V	15 string LiFePO4 battery pack
8	62.0V	60.4V	other
9	58.4V	56.8V	other

Table 7: Inverter configuration option

NO.	Description	Selectable option
1	Input voltage range Setting	Wide/Normal
2	Output voltage Setting	220/230/240Vac
3	Output frequency Setting	50/60Hz/Automatic
4	AC charging voltage setting	AC charge off, b1, b2, b3, b4, b5, b6, b7, b8
5	AC Charger current Setting	16A/32A/48A/64A/80A
6	DC priority / AC priority / intelligent mode selection setting	DC mode priority / AC mode priority, Intelligent mode
7	DC conversion voltage point setting (Switch from battery mode to AC mode)	42.0V/44.0V/46.0V/48.0V/50.0V/51.2Vdc
8	Battery low voltage shutdown point setting	38.0V/40.0V/42.0V/44.0V/46.0V/47.2Vdc
9	Battery capacity setting	65/80A/00/150/200/250/300/400/500/600/800AH

1. Input voltage range Setting

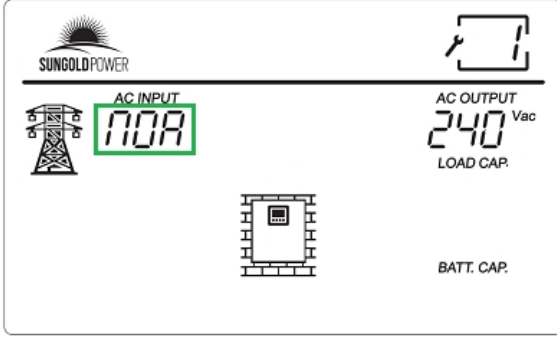
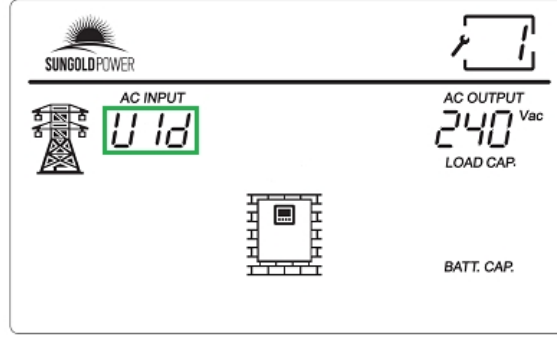
	
Narrow range mode	Wide range mode

2. Output voltage Setting

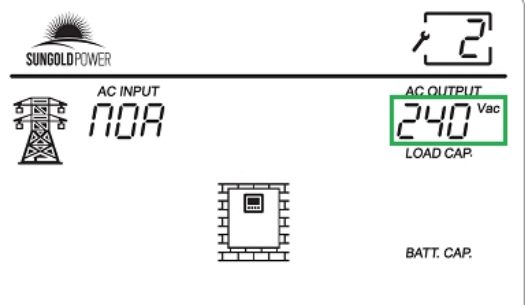
	220 ^{Vac}	Set output voltage into 220Vac
	230 ^{Vac}	Set output voltage into 230Vac
	240 ^{Vac}	Set output voltage into 240Vac

3. Output frequency Setting

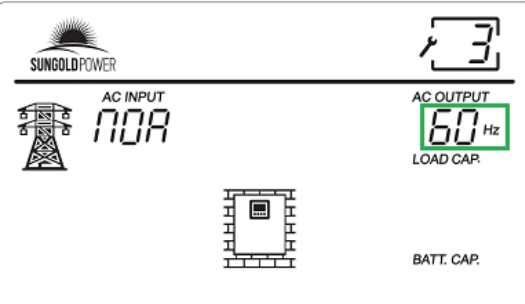
	50 ^{Hz}	Set output frequency into 50Hz
	60 ^{Hz}	Set output frequency into 60Hz
	RF ^{Hz}	Set output frequency to adaptive, The output frequency in battery mode is subject to the mains input frequency

4. AC charging voltage setting

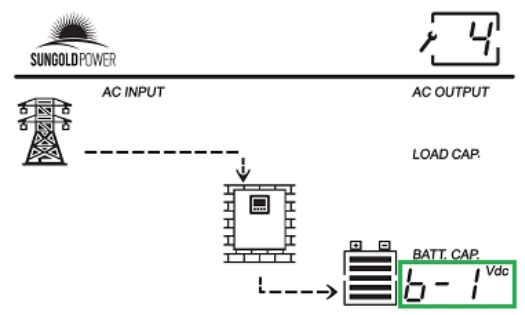
	OFF	Turn off AC charging
	6-1 ^{Vdc}	Boost.V/Float .V 56.0V/54.8V (AGM)
	6-2 ^{Vdc}	Boost.V/Float .V 58.4V/57.6V
	6-3 ^{Vdc}	Boost.V/Float .V 57.6V/57.2V
	6-4 ^{Vdc}	Boost.V/Float .V 56.8V/56.0V
	6-5 ^{Vdc}	Boost.V/Float .V 54.8V/54.0V
	6-6 ^{Vdc}	Boost.V/Float .V 54.0V/53.6V
	6-7 ^{Vdc}	Boost.V/Float .V 53.2V/52.4V
	6-8 ^{Vdc}	De sulphation cycle, Boost.V 62.0V, Float .V 4 hours then off

5. AC Charger current Setting

	80A	Set AC charging current into 80A
	64A	Set AC charging current into 64A
	48A	Set AC charging current into 48A
	32A	Set AC charging current into 32A
	16A	Set AC charging current into 16A

Maximum rated charge current can be divided into 5 different stall for adjusting.

6. DC priority / AC priority / intelligent mode selection setting

AC mode priority	DC mode priority	Intelligent mode

7. DC conversion voltage point setting (Switch from battery mode to AC mode)

	42.0 ^{Vdc}	DC voltage is lower than 42.0V
	44.0 ^{Vdc}	DC voltage is lower than 44.0V
	46.0 ^{Vdc}	DC voltage is lower than 46.0V
	48.0 ^{Vdc}	DC voltage is lower than 48.0V
	50.0 ^{Vdc}	DC voltage is lower than 50.0V
	51.2 ^{Vdc}	DC voltage is lower than 51.2V

Note: This function is only effective in DC priority and intelligent mode.

8. Battery low voltage shutdown point setting

	38.0 ^{Vdc}	Battery voltage is lower than 38.0V
	40.0 ^{Vdc}	Battery voltage is lower than 40.0V
	42.0 ^{Vdc}	Battery voltage is lower than 42.0V
	44.0 ^{Vdc}	Battery voltage is lower than 44.0V
	46.0 ^{Vdc}	Battery voltage is lower than 46.0V
	47.2 ^{Vdc}	Battery voltage is lower than 47.2V

9. Battery capacity setting



	65	200	500
	80	250	600
	100	300	800
	150	400	

Setting the correct user access battery capacity is conducive to the inverter to display the battery capacity more accurately.

LCD display meaning

Table 8: display meaning

 Normal	Inverter normal work
 Line Mode	Line mode is enabled
 PV Mode	PV input is connected
 Batt. Mode	Battery backup mode is enabled
 Bypass Mode	Bypass mode is enabled
 Fault Mode	This icon is showed when there is a fault event. The number is the fault code which can be referred to specific fault event (please refer to Section “Table 6 Fault code meaning”).
 AC Icon	AC Icon
 BYPASS	Bypass Icon
 888 ^{Vac} Hz	AC Voltage and Frequency display
 LOAD CAP. KW 888%	The load icon and level bar indicates the loading level (0~100%), Loading display
 BATT. CAP. Vdc 888%	Level of remaining battery capacity, Battery voltage
 PV (Solar system)	PV (Solar system)
 PV INPUT Vdc 888	PV (Solar system) input voltage
 Total Energy Generated 888.88 kWh	PV (Solar system) power generation display

	MPPT solar charger normal working
	Inverter

Operating Indicators

AC Mode:

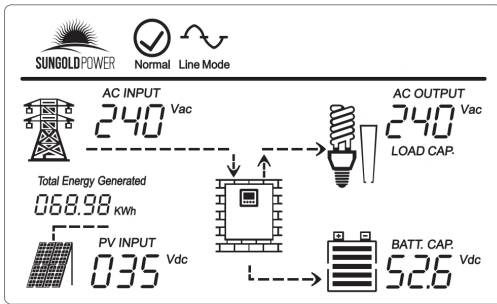

AC+PV Mode:

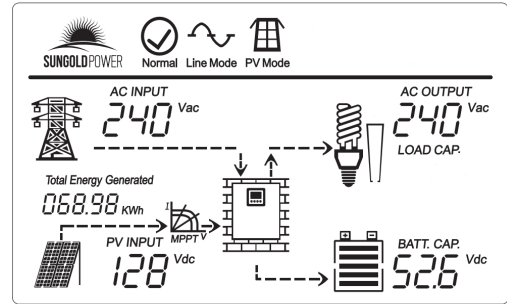

DC Mode:

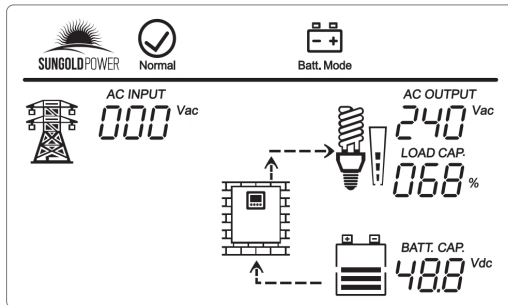

PV Mode:

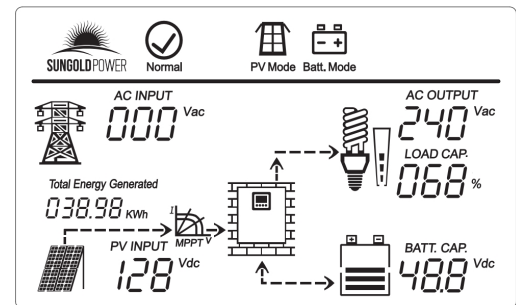

Alternating display of AC voltage and frequency, battery voltage and battery capacity every 5 seconds

Fault Mode:

The upper left corner of the LCD shows the fault code and buzzer ringing.

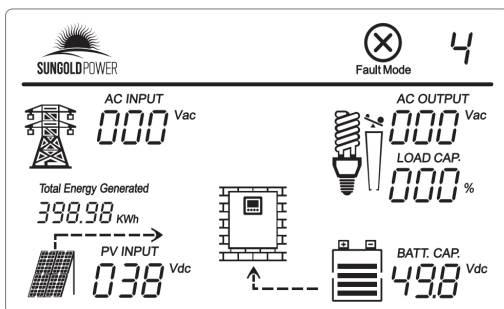

Table 9: Fault code meaning

Fault code	Fault	Reason and Solution
1	Over temperature, fan fault (alarm light on)	Inverter operate environment is very bad, insufficient ventilation and indoor temperature is very high. Close the inverter and wait for 10 minutes, after inverter cool, start again, if fan fault, please replace with a new fan.
2	Overload (alarm light on)	Connecting load power is over than inverter's rated power, if reduce the load equipments quantity, inverter will work again.
3	Output short circuit (alarm light on)	Close the inverter and disconnect all load equipment, inspect load equipments if any of them had fault or internal short circuit, then start the inverter again. If still fault, please consult with manufacture.
4	Over temperature (alarm light on)	Inverter operate environment is very bad, insufficient ventilation and indoor temperature is very high. Close the inverter and wait for 10 minutes, after inverter cool, start again.
5	Low battery voltage (alarm light on)	Battery damage; Battery deeply discharged, so need to charge again; battery problem, please replaces the battery. Inverter charger no work, please consult manufacture.
6	Reverse input (alarm light on)	Connect input and output again in correct way.
7	Semi-wave short circuit (unusual load)	The connecting load power is over than inverter's rated power, after reduce load equipments quantity, inverter will work again.
8	Over charge (alarm light on)	Battery type selection incorrect; Charger damage, please consult manufacture for help.
9	Battery over voltage (alarm light on)	C heck if battery bank dc voltage is corresponding to this inverter requested dc voltage.

SPECIFICATIONS

Table 10: Line Mode Specifications

MODEL	LFPV8~12KW
Rated power	8~ 12KW(Split-phase)
Input Voltage Waveform	Sine wave(Utility or Generator)
Nominal Input Voltage	240Vac(HOT1+HOT2)
Low Line Disconnect	180Vac±4%(NOR)
	140Vac±4%(WID)
Low Line Re-connect	190Vac±4%(NOR)
	150Vac±4%(WID)
	Note: 1.NOR setting can be used for general electrical appliance 2. WID setting can be used only for some special load, Such as lamp, fan.
High Line Disconnect	270Vac±4%(NOR)
	270Vac±4%(WID)
High Line Re-connect	260Vac±4%(NOR)
	260Vac±4%(WID)
Max AC Input Voltage	270VAC
Nominal Input Frequency	50Hz/60Hz (Auto detection)
Low Line Frequency Disconnect	40±0.3Hz for 50Hz, 50±0.3Hz for 60Hz
Low Line Frequency Re-connect	41±0.3Hz for 50Hz, 51±0.3Hz for 60Hz
High Line Frequency Disconnect	55±0.3Hz for 50Hz, 65±0.3Hz for 60Hz
High Line Frequency Re-connect	54±0.3Hz for 50Hz, 64±0.3Hz for 60Hz
Output Voltage Waveform	Same as Input Waveform
Output Short Circuit Protection	Air switch
Efficiency (Line Mode)	>98%
Transfer Time	15ms (typical) 20ms max(WID)

Note: NOR – Normal range; WID-Wide range

Table 11: Invert Mode Specifications

MODEL	LFPV8K-48-120A-SP	LFPV10K-48-120A-SP	LFPV12K-48-120A-SP
Output Voltage Waveform	Pure Sine Wave		
Rated Output Power	8000W	10000W	12000W
Rated Output Power (Split phase model)	HOT1-N:4000W	HOT1-N:5000W	HOT1-N:6000W
	HOT2-N:4000W	HOT2-N:5000W	HOT2-N:6000W
	HOT1-HOT2:8000W	HOT1-HOT2:10KW	HOT1-HOT2:12KW
	HOT1 load> HOT2 load, HOT1-N must be used preferentially for single load, The total load connected shall not be greater than the rated power of the inverter		
Power Factor	0.9 - 1.0		
Nominal Output voltage	120V/240V		
Minimum Peak Output Voltage at Rated Power	>200Vac		
Output Frequency(Hz)	50Hz / 60Hz \pm 0.3Hz		
Output Voltage Regulation	\pm 10%		
Nominal Efficiency	>87% (@Normal DC Input; >60% R load)		
Over-Load Protection	105% <load<125%, beeps 0.5s every 1s, and Fault after 60s. Load>125%, beeps 0.5s every 1s, and Fault after 20s.		
Capable of starting electric motor	YES		
Output Short Circuit Protection	Current limit (Fault after 10s), Air switch		
DC voltage			
Nominal DC Input Voltage	48.0Vdc		
Min DC start voltage	44.0Vdc		
Low DC Alarm	42.0 \pm 0.6Vdc		
Low DC Shut-down	40.0 \pm 0.6Vdc(Can set)		
Low DC Shut-down Recovery	44.0 \pm 0.6Vdc		
High DC Shut-down	64.0 \pm 0.6Vdc		
High DC Shut-down Recovery	62.0 \pm 0.6Vdc		

Table 12: AC Charger Mode Specifications

Nominal Input Voltage	240Vac(HOT1+HOT2)
Input Voltage Range	194 ~258Vac(NOR)
	160 ~265Vac(WID)
High Voltage Disconnect	265Vac±4%(NOR)
	265Vac±4%(WID)
High Line Re-connect	258Vac±4%(NOR)
	258Vac±4%(WID)
Low Voltage Disconnect	194Vac±4%(NOR)
	160Vac±4%(WID)
Low Line Re-connect	199Vac±4%(NOR)
	165Vac±4%(WID)
Nominal Output Voltage	According to the battery type
Nominal Charge Current	Max 80A
Charge current tolerance	±5A
Over Charge Protection	Bat. V ≥61.0Vdc, Fault, Buzzer alarm for 48Vdc (beeps 0.5s every 1s & fault after 60s)
Charge Algorithm	Three stage: Boost CC (constant current stage) → Boost CV (constant voltage stage) → Float (constant voltage stage)

Note: NOR – Normal range; WID-Wide range

Table 13: Solar Charger Mode Specifications

Rated Battery voltage	48VDC
Rated charge current	60A
Input voltage range	60-145Vdc
PV charging starting voltage	PV.V>Bat.V+3.0V
Max. PV open circuit array voltage	155Vdc
Max. recommended input power (W)	3500W
Dual MPPT charger	YES
Dual MPPT charging current	120A (60A+60A)
Dual MPPT Max. recommended input power (W)	7000W (3500W+3500W)

Table 14: General Specifications

MODEL	LFPV8K-120A-SP	LFPV10K-120A-SP	LFPV12K-120A-SP
Indicators	LED+LCD Display		
Protections	Low battery, over charging, over load, over temp.		
Remote control	YES		
Operating Temperature Range	0°C ~ 50°C		
Storage temperature	-15° C ~ 60° C		
Operation humidity	5% ~ 95% (non-condensing)		
Earthing ABYC standard (Optional)	Follow customer requirement Inverter mode: the neutral and the earth joined ; Line mode: the neutral and the earth separated. Use a Relay to realize the function.		
Audible Noise	65dB max		
Cooling	Forced air, variable speed fan		
Size (L*W*H mm)	650*449*223.5mm	650*449*223.5mm	650*449*223.5mm
Net weight (Kg)	57.0kg	64.5kg	70.5kg

Product specifications are subject to change without further notice.

APPENDIX A

How to Select and Configure PV Panels

The following parameters can be found in each PV panel's specification:

- P_{max} : Max output power (W)
- V_{oc} : open-circuit voltage (V)
- I_{sc} : short-circuit current (A)
- V_{mp} : max power voltage (V)
- I_{mp} : max power current (A)

PV panels can be connected in series or parallel in order to obtain the desired output voltage and current which meets the inverter's allowed range.

Example 1 - How to connect 48V 8000W model to PV panels with the following parameters?

- P_{max} : 260W
- V_{oc} : 37.7V
- I_{sc} : 8.89A
- V_{mp} : 30.9V
- I_{mp} : 8.42A

- (1) The max. PV input power for 48V 8000W model is 3500W,
 $3500W / 260W = 13.46$ min. 13 PV panels shall be connected.
- (2) Best Operating Voltage Range is 60~145V,
 $145V/30.9V = 4.69$ max. Number of PV panel in series is 4.
- (3) Max. input charging current is 60A,
 $60A/8.42A = 7.13$ max. Number of PV panel in parallel is 7.
- (4) Taking (1)~(3) into consideration, the optimized configuration is 3 PV panels in series as a string, and 5 strings in parallel (as shown below).

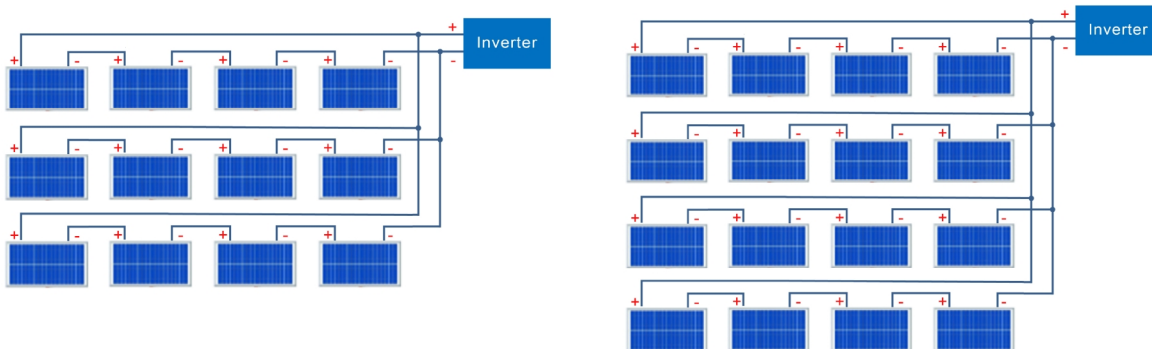

Considering the parameters of solar panels, the total power of practical application is about 3500W

(5) Check again the V_{oc} and I_{sc} of PV string,

V_{oc} of string is $4 \times 37.7V = 150.8V < 155V$ (Max. PV Input Voltage) \triangleright OK

I_{sc} of string is $3 \times 8.89A = 26.67A < 60A$ (Max. PV Input Current) \triangleright OK

I_{sc} of string is $4 \times 8.89A = 35.56A < 60A$ (Max. PV Input Current) \triangleright OK

APPENDIX B (Wi-Fi Plug Pro)

Quick Installation Guideline

1. Installation

①Take out the Wi-Fi module packaging box and first confirm whether the contents of the Wi-Fi module are correct. The list is As shown below:



Wi-Fi module packaging



Wi-Fi Module Item List

②After checking the module list, install the Wi-Fi module antenna, and install it according to the following diagram.



Wi-Fi Plug Pro

③Find the installation interface of the Wi-Fi module - RS232 interface on the inverter, and RS232 indicates the location in the figure below.

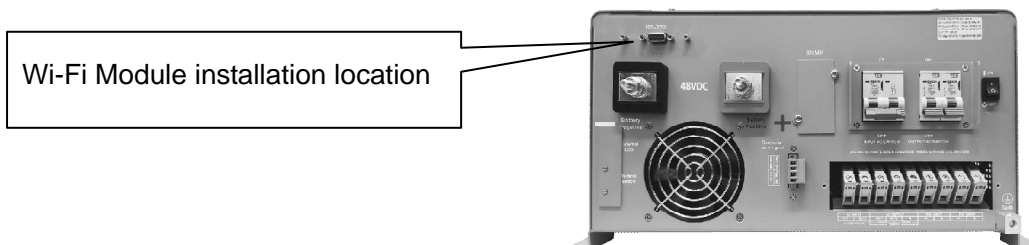

④Insert the Wi-Fi module into the RS232 interface, fix and lock both sides with screws, and the Wi-Fi module is installed OK.



2. Wireless Router Connection

2.1 Download APP

Scan the QR Code on the right side and download the APP.



SmartESS(iOS)



SmartESS(Android)

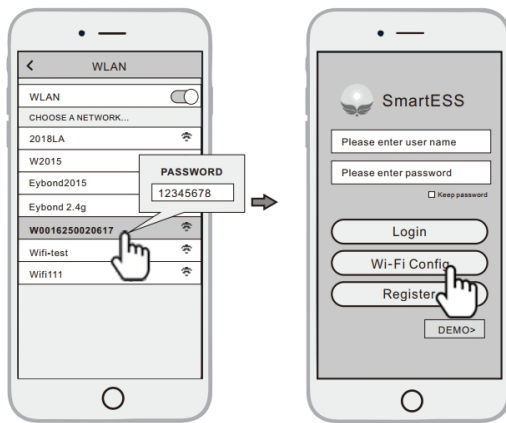

2.2 Connect Wi-Fi Datalogger

- ① Select the same number of Wi-Fi Plug Pro PN to connect on your Phone WLAN. (InitialPassword:12345678)
- ② Open the APP, tap the **Wi-Fi Config** button to enter this page.

2.3 Network Setting

- ① Then tap the Network Setting button.
- ② According to the prompts, type in the information to finish the network setting.
- ③ After the Wi-Fi Plug Pro is restarted, reconnect the Wi-Fi which connected by step 2.1.

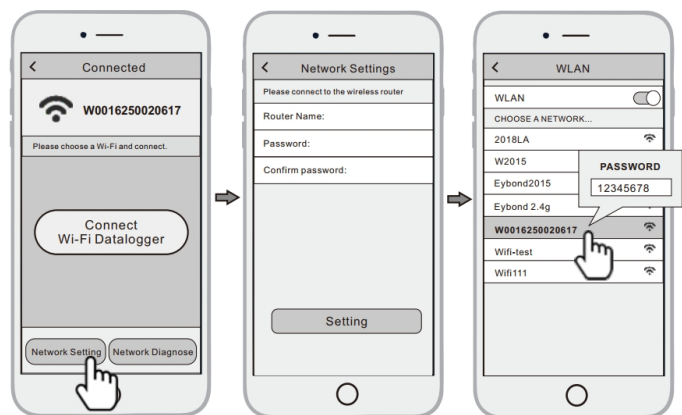

3. Create Account And Add Datalogger

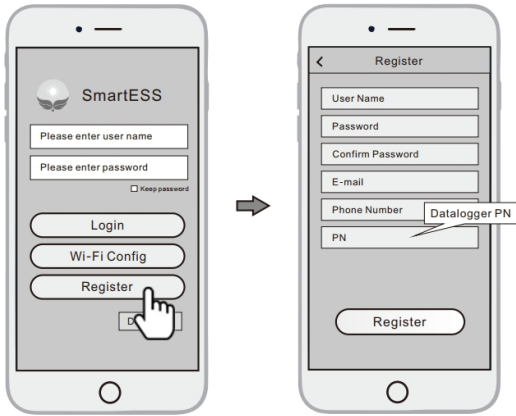

3.1 Create Account

- ① Open the APP, tap the Register button to enter this page.
- ② According to the prompts, type in the information to create an account.

3.2 Add Datalogger

- ① Login the account and click the **Datalogger** button. Tap the “+” button on the top-right corner of the Datalogger page.
- ② Scan the PN on the Wi-Fi Plug Pro, or input it manually.
- ③ According to the prompts, type in the information to finish add datalogger.

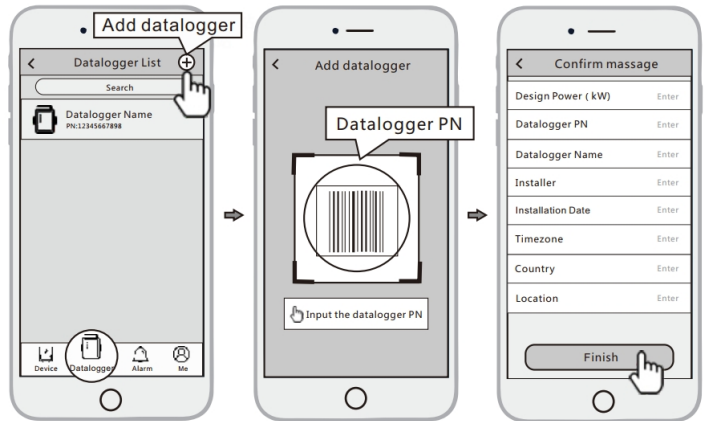

DISPOSAL

In the event the product reaches the end of its service life, please contact the local dealer for disposal instructions.



The product must not be disposed of with the household waste.



Disposal of the product at the end of its service life shall be done in accordance with applicable disposal regulations for electronic waste.