



## ***VX328 Instruction Manual***

# **Quick Start Guide**

For Gauge Hole Receivers

Not all features listed in this QSG  
are available on all models.

---

### **THIS PACKAGE CONTAINS**

Trim Bezel	x 1
Power/Speaker Harness	x 1
Mounting Screws	x 4
User's Manual	x 1

# Installation

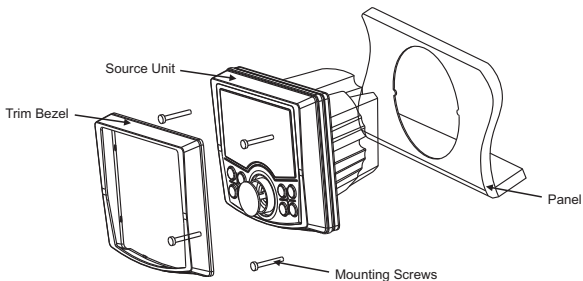

## Mounting (Using Mounting Plate)

1. Choose a mounting location on the dash board or instrument panel that will allow room behind to run radio cables to the power source. Consider how you will use the AUX IN, LINE OUT and USB connectors and route the appropriate extension cables to an accessible area.

2. Once you have determined a mounting location, you will need to cut a circular hole 3" (77mm) in diameter. At least 3.75 inch depth is needed to mount the radio.

**IMPORTANT! Do not mount this unit where it can be submerged in water.**

3. Slide the mounting plate over the backside of the unit and secure with the supplied screws.

4. Press on the trim bezel to the front side of the unit.

5. Plug in all wiring harnesses and cables. Refer to the wiring diagram for wire harness connection types.

# WIRING DIAGRAM

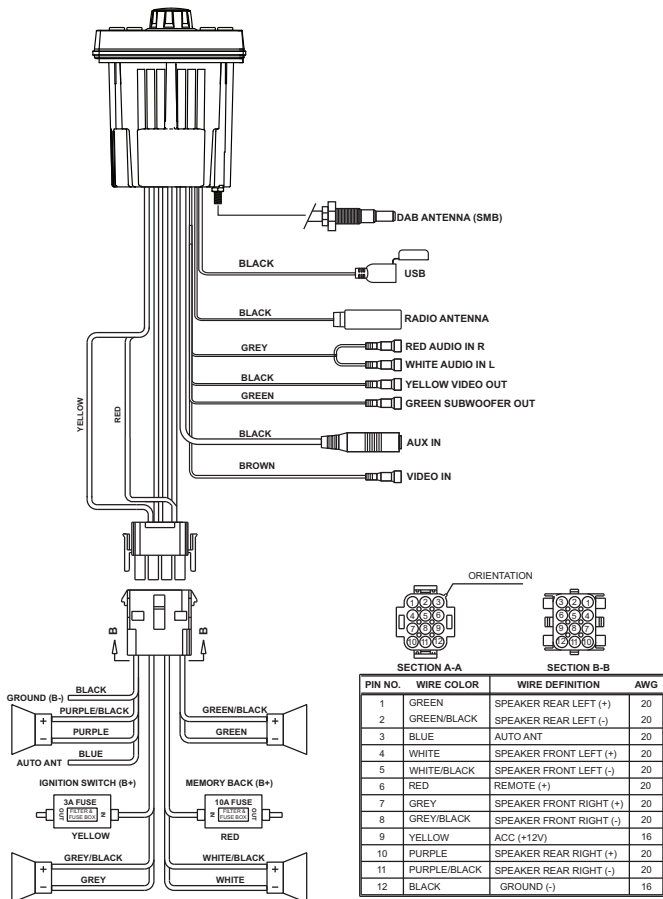

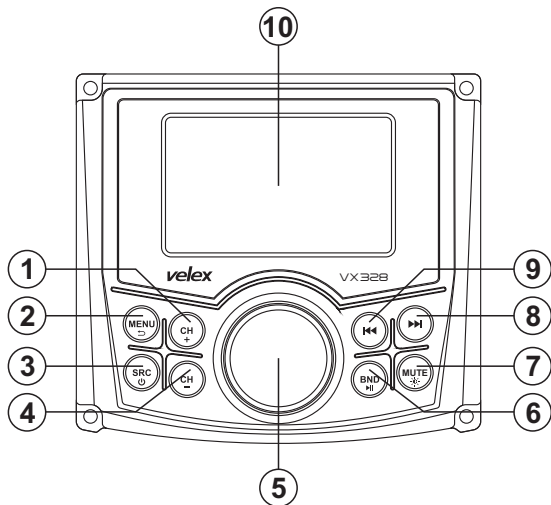

## Control Locations - Receiver

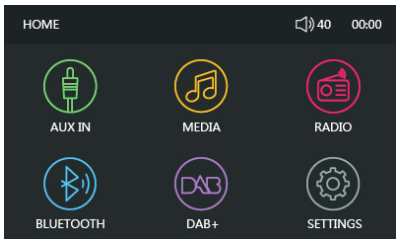

- ① Next Preset Stations (Radio -FM/DAB+)
- ② MENU / Return
- ③ Source / Power
- ④ Previous Preset Stations (Radio- FM/DAB+)
- ⑤ VOL Knob (Rotate)/ Confirm (Press)
- ⑥ Play / Pause | Band (Radio) | Video I/O Switch (Press and Hold While Playing Video)
- ⑦ Auto Programming Station (Radio) / Button Backlight on/off
- ⑧ Tune Up / Next Track
- ⑨ Tune Down / Previous Track
- ⑩ TFT Display

## General Operation



Power on/off - Press the '  ' button to turn the unit on. Press and hold '  ' to turn unit off.



Changing Modes Press 'SRC' button to switch between Radio,AUX IN, Bluetooth Music, Media (USB), DAB+ modes

MENU- Press MENU button and use the Volume Knob to select between MEDIA, RADIO, BLUETOOTH, AUX IN, SETTINGS. Short Press the Volume Knob to confirm the selection.

Settings - Select 'SETTINGS' from MENU to set System time, Time format (12/24 Hours), Language, Radio Region (Europe/American), Restore Factory Setting, Software Version.

Volume - Rotate the Volume Knob to adjust volume (AUX IN/MEDIA/RADIO /BT/DAB+ modes)

When the volume level interface is still on display quick press the Volume Knob to enter settings for BAS, MID, TREB, BAL, FAD, SUB, LOUD OFF, EQ in sequence, then rotate the Volume Knob to set the required level. Use MENU/RETURN button to quit setting, or wait for time out to return to the previous status.

AMS/  Press 'AMS/  ' to dim/resume the back light

## FM Tuner Operation

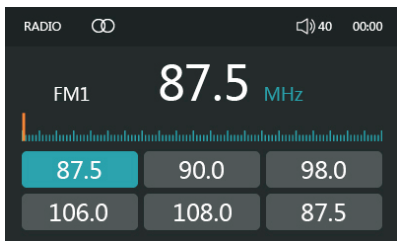

**Country Selection** - When power is first applied, press MENU button to enter the main menu, then rotate the Volume Knob and select 'SETTINGS', rotate the Vol Knob to highlight the Radio Region to toggle between European and USA band sets.

**Seek Tuning** Press and hold << or >> for more than one second to seek to the next strong station.

**Manual Tuning** - Press << or >> momentarily to move radio frequency up or down one step at a time.

**Auto Programming of Radio Station** - Press and hold 'AMS 🌟' button for 1 second, VX328 will commence searching the band for radio stations and automatically stored in the available preset memory location. The new stations will replace any stations previously stored in that band.

**Band** - Press BND >|| to select between FM1, FM2, Fm3. Up to six presets can be programmed for each band. Enabling up to 18FM stations to be stored in memory.

**Recalling Presets** - Press the CH+/CH- button to cycle through the 1-6 presets in the current band.

## MP3/WMA Operation

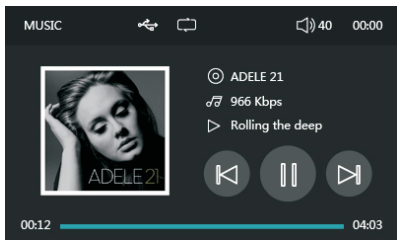

When an USB stick is plugged in, VX328 start to play the audios from the first location.

If user want to play MOVIE/PHOTO on the USB stick, press MENU then enter MEDIA selection, MUSIC/MOVIE/PHOTO will be displayed on LCD screen, rotate the VOL Knob to make choice.

Pause - To pause the audio/video, press the >|| button once. Press the >|| button again to resume playing.

Track Select - Press >> to skip to the beginning of the next song.  
- Press << to skips to the beginning of the previous song.

Short press Vol Knob and the song list will be displayed on the screen, rotate the Vol Knob to select the desired song and press 'VOL' to confirm the selection.

Rotate the Volume Knob to adjust volume, when the volume level interface is still on display, quick press the Volume Knob to enter settings for BAS, MID, TREB, BAL, FAD, SUB, LOUD OFF, EQ in sequence, then rotate the Volume Knob to set the required level. Use MENU/RETURN button to quit setting, or wait for time out to return to the previous status.

Fast Forward and Reverse - Press and hold >> or << to fast forward or reverse a track.

## MUSIC/MOVIE/PHOTO Operation

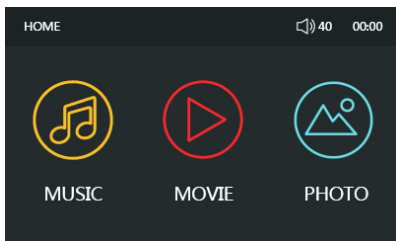

When an USB stick is plugged in, VX328 will auto detect the audio files and start to play from the first location.

When VX328 is playing audio, press and hold the VOL knob for 1 second, MUSIC /MOVIE/PHOTO selection will be toggled, rotate and press the VOL knob to confirm the selection.

Or press MENU button and select MEDIA, MUSIC/MOVIE/PHOTO selection will be toggled, rotate and press the VOL knob to confirm the selection.

When MOVIE is selected, short press Vol Knob and the video list will be displayed on the screen, rotate the Vol Knob to select the desired video and press 'VOL' to confirm the selection.

Rotate the Volume Knob to adjust volume, when the volume level interface is still on display, quick press the Volume Knob to enter settings for BAS, MID, TREB, BAL, FAD, SUB, LOUD OFF, EQ in sequence, then rotate the Volume Knob to set the required level. Use MENU/RETURN button to quit setting, or wait for time out to return to the previous status.

Rear Camera for easy reversing - If you've got a rear camera installed, you can use it to help your park.

Rear view camera installation, plug the camera video in cable to the rear 'CAMERA IN' fly lead (Yellow Cap), connect the Green 'CAMERA' reverse cable to reverse gear.

Whenever you put your vehicle in reverse, you will instantly bring the video feed up on screen. The on screen guidelines help you to back in smoothly and safely.

When PHOTO is selected, VX308 will automatically display the photos by slide show.



## Bluetooth Operation

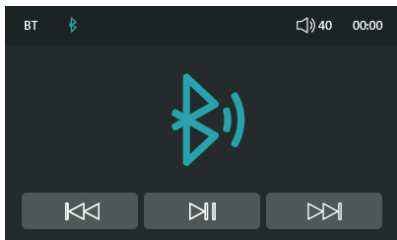

Preparation - Before using a Bluetooth device, it must be paired and connected. Ensure that Bluetooth is activated on your device before beginning the pairing process.

Activate the Bluetooth on your smartphone to search for new devices. Connect with the device name 'VX328' when founded. Once pairing is successful, '  ' icon on the top title will change from white to blue color which means 'device paired'.

Note: The head unit can be in any mode of operation when pairing is performed.

After paired, select BT mode from MENU, BT music interface will be displayed on screen, now select and play your desired music on your smart phone or media player.

The head unit supports A2DP wireless streaming audio from a Bluetooth mobile device directly to your head unit. The following function can be used to control the music:

Press >> to skip to the next available audio track.

Press << to skip to the previous audio track.

Press >/|| to toggle between play and pause during playback.

# DAB+ Operation

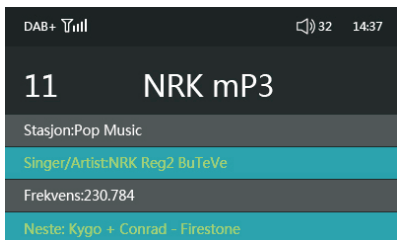

Note: DAB+ (Digital Audio Broadcasting) is only available for some European Countries and Australia where has the DAB+ station coverage.

Select DAB+ from MENU or press SRC button to switch to DAB+ mode, VX328 will automatically scan for local digital stations. This process may take a few seconds depending on the numbers of stations available. As DAB stations are found, they will be automatically stored into the DAB band memories. Once scanning is complete, VX326 will begin playing the station stored in the first memory location. And the station info will be displayed on the screen.

Tuning DAB stations

Press CH+ or CH- button to tune to next/previous DAB station.

Auto Programming Station

Press and hold 'AMS'  button to manually force a search for new stations.

## Trouble Shooting

ISSUE	OPTIONS
Unit will not turn on (no power)	Cause: Yellow/red wire not connected or incorrect voltage Action: Check connections for proper voltage (11-16V DC)
	Cause: Black wire not connected Action: Check connection to ground
	Cause: Fuse blown Action: Replace the fuse
Unit has power (but no sound)	Cause: Speaker wire not connected Action: Check connections at speakers
	Cause: One or more speaker wires touching each other or touching chassis ground Action: Insulate all bare speaker wires from each other and chassis ground
Unit blows fuses	Cause: Yellow/red wire touching chassis ground Action: Check for pinched wire
	Cause: Speaker wires touching chassis ground Action: Check for pinched wire
	Cause: Incorrect fuse rating Action: Use fuse with correct rating

# Specifications

## General

Power supply requirements: DC 12V Negative Ground

Load impedance: 4-8 Ohms/channel

Maximum output power: 40W x 4 (CH)

Operate temperature: -10-50°C

## MULTIMEDIA SUPPORT

**AUDIO FORMAT:** MP3/WMA/OGG/FLAC/APE/AAC/AC3

**VIDEO FORMAT:** MPEG 1/ MPEG 2/ MPEG 4-XVID/DIVX/H.264/H.263/WMV9/RMVB

**PHOTO:** JPEG/BMP

**FM Tuner:** Tuning range: 87.9MHz-107.9MHz (USA)

87.5MHz-108MHz (EUR)

**DAB+:** Tuning Range: BAND III 174-240 Mhz

## USB playback

Signal to Noise Ratio: 55dB

Frequency Response: 50Hz- 20KHz

A/D Conversion Filter: 16BIT

USB Storage Capacity: 16GB Max

## Bluetooth

Version: 4.0

\*Note: Specification may change without notice.