

Yaber

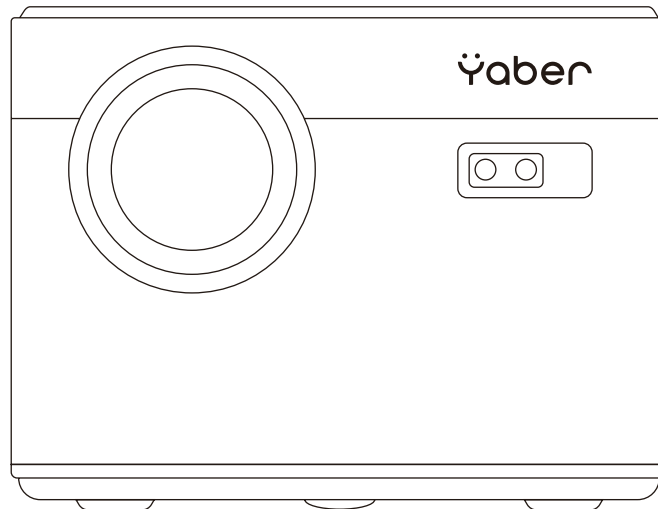

U11 SMART PROJECTOR **EN**

CONTENS

YABER Lifetime Professional Support	1
Tips	1
Package List	2
Projector Specifications	3
Projector Overview	3
Remote Contol	5
Installation	6
1. Installation Method	6
2. Projection Distance and Size	7
3. Install on the Ceiling	7
Use The Projector	8
Setting Up The Projector	9
1. Select The Insert Signal Source	9
2.USB Disk Input Mode	9
2.1 Play Video/Audio/Image/Office in the USB Disk Input Mode	9
2.2 Play Interface	10
3. WiFi Setting	13
3.1 iOS Cast (for iOS Devices)	13
3.2 Maxhub Share (for Android Devices)	13
4. Bluetooth Setting	14
5. Projector Image Setting	15
5.1 Projection Mode	15
5.2 Focus	16
5.3 Keystone Correction	16
Signal Lines Connection	19
1. Connect the Devices via the HDMI port	19
2. Connect to the DVD Player	19
3. Connect to the Sound bar/Speaker	20
4. Connect to the Computer	20
Warranty	21

Yaber Lifetime Professional Support

Dear customer,

Thank you for your support of YABER! Before using your projector, please take a moment to read through the manual thoroughly. Should you encounter any issues, simply email **aftersales@yaber.com** with your order number and a brief explanation of the problem. Our team will respond within 24 hours with a fast and effective solution.

Many common issues such as signal or sound problems, failed Bluetooth or WiFi connections, dark spots, or choppy animations can often be resolved through simple adjustments to the settings. Rest assured that all of our projectors have undergone a rigorous 100% inspection and packaging process prior to shipping.

If you have any further questions or concerns, please don't hesitate to contact us. We welcome the opportunity to improve and guarantee that we will work with you to find a satisfactory solution.

Thank you for your understanding and for choosing YABER!

Best regards, The YABER Service Team.

Tips

1. Do not place projector in too warm or too cold room, because the high temperature or low temperature will shorten lifespan of the device. The working environment would be 5°C ~35°C better.
2. The ventilation is equipped for the projector to work stably. Don't cover the vent with cloth, blanket or other things. Don't insert anything into the slit of the projector, or it may produce a short circuit or an electric shock to your device and cause damage.
3. The projector shall be strictly protected from strong impact, extrusion and vibration. Do not try to move and on strong impact, extrusion and vibration. Do not try to move and the internal circuit faults.
4. Lens, as the core component of the projector, is directly related to the picture definition and effect. The excessive dust thereon will affect image quality. The dirty lens shall be wiped with soft cotton cloth for the glass lens surface. Hard cloth or abrasives shall not be used.

Package List

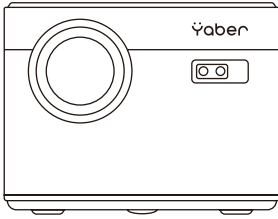

Yaber U11 Projector

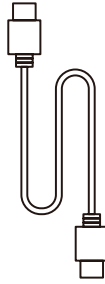

HDMI Cable

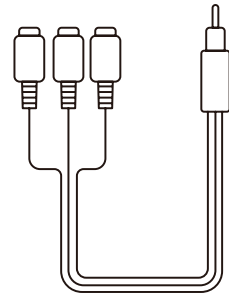

3-in-1 AV Cable

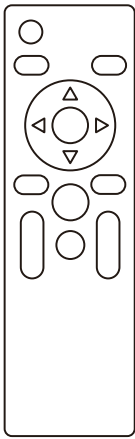

Remote Control

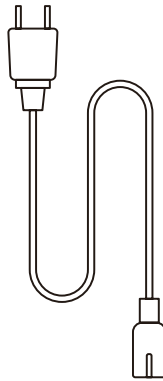

Power Cord

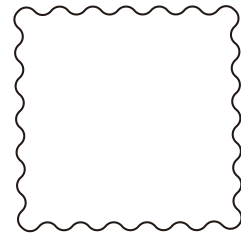

Cleaning Cloth

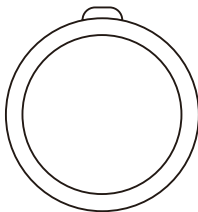

Lens Cover

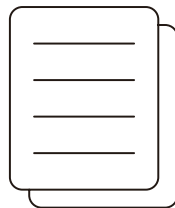

Quick Tutorial

Projector Specifications

Model No. U11			
Native Resolution	1920*1080	Aspect Ratio	4:3/16:9
Display Tech	LCD	Light Source	LED
Color Game	16.7M Full	Size	8.32x6.3 inch
Weight	5.29 lb	Power Voltage	AC100-240V ~ 50/60Hz
Output Port	Headphone	Input Port	RJ45/HDMI/USB/AV
Projection Method	Front/Rear on Desk, Front/ Rear on Ceiling		
Operation Mode	Remote control		
Video Format	MP4/MKV/WMV/3GP/MPG/VOB/TP/TS/DAT/MOV/FLV/ 4K H.264/H.265(≤30fps)		
Audio Format	AAC_LC/HE_AAC/HE_AACV2/LPCM/MP3/APE/MP3		
Image Format	JPG/JPEG/BMP/PNG		
Document Format	TXT/WORD/EXCEL/PPTX		

Projector Overview

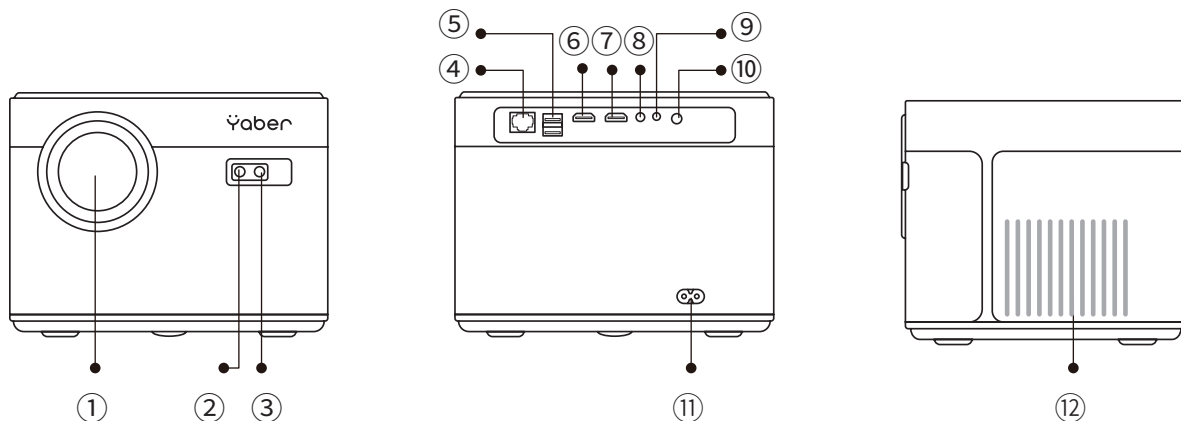

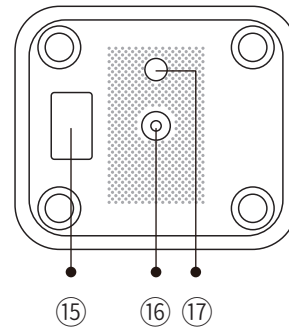
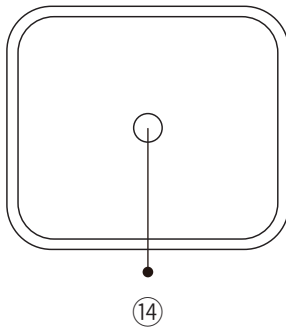
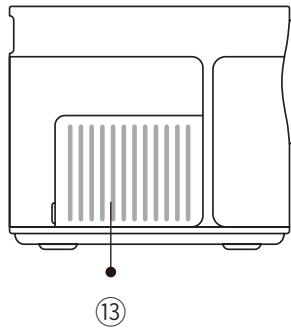

1	Projector lens	Optical coated glass lens
2/10	IR window	Infrared signal receiver
3	Camera	Auto-focus lens
4	RJ45	Network port
5	USB Ports	USB 1 port /USB 2 port
6/7	HDMI Ports	HDMI Input
8	AV Interface	Separates audio and video transmission
9	Headphone Jack	3.5mm Headphone Output
11	Power Cord Port	Insert the power cord
12/13	Cooling outlet	Prevent the projector from overheating
14	Power button	Turn on/off power
15	Bottom Label	Nameplate on the bottom of the projector
16	Machine Feet	Height adjustment machine feet
17	Screw hole	Bracket screw hole (1/4 inch), also supports hoisting

Remote Control

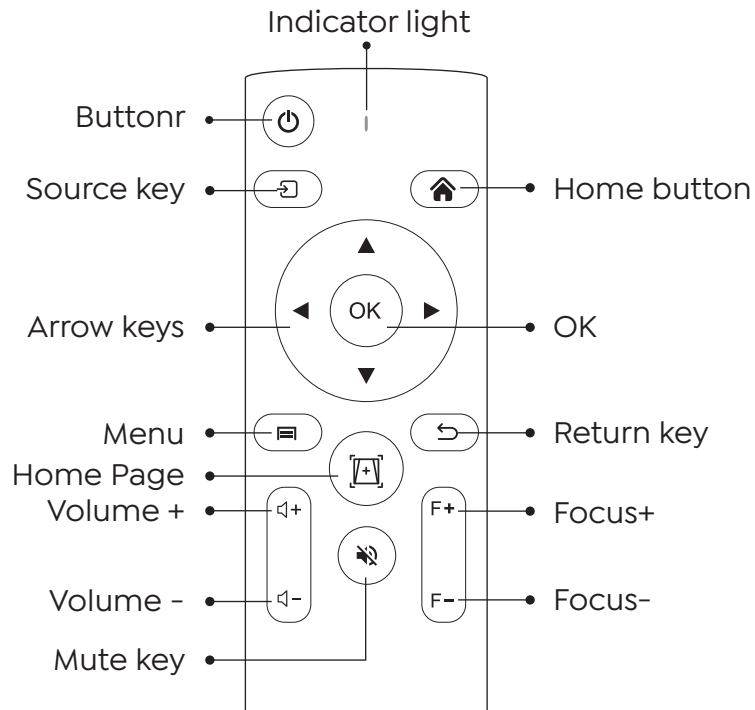

Button	Turn on/off the power
Source key	Select the input signal source
Arrow keys	Used to adjust the parameter of the projector in the menu mode
Menu	Press once: Operate picture and sound settings in AV or HDMI Mode Press twice in succession: select 16:9/4:3 projection
One-touch autofocus auto-trapezoid	Press once: automatic image focus, automatic trapezoidal adjustment
Volume +	Volume up
Volume -	Volume down
Mute key	Close the sound
Home button	Return to the home page
OK	Confirm the option/Play or pause the video
Return key	Return to the previous menu
Focus+ / Focus-	Screen focus adjustment

Note:

1. Install 2 pieces of AAA batteries into the remote controller before using it. Do not combine new batteries with old ones in remote controller, which can cause operation failure due to insufficient power supply.
2. When using the remote controller, please make sure that the signal transmitter of the remote controller aims at infrared signal receiver of the projector.
3. If you are not using the remote controller for an extended period, please take out batteries to prevent batteries leakage.

Installation

1. Installation Method

The projector can be hung on the ceiling with special hanger frame, and placed on the stable desk to project the image according to the operating environment and requirements. The installation method is as follows:

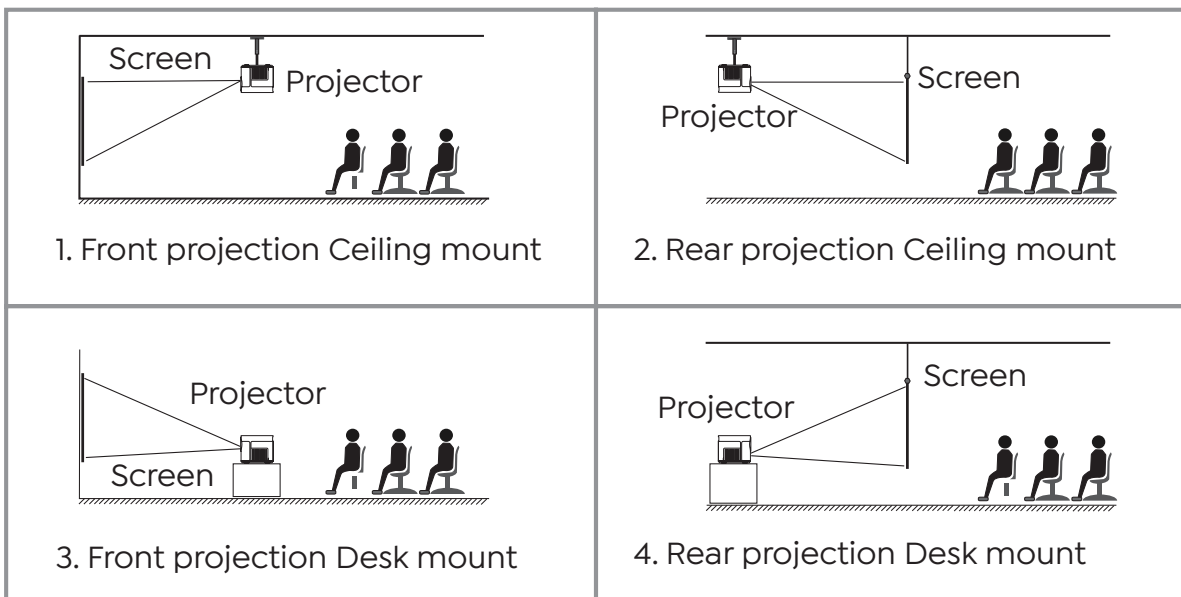

2. Projection Distance and Size

Aspect Ratio: 16:9	
Distance (ft.)	Screen Size
5	50"
8	80"
10	100"
12	120"
13.4	120"
16.8	150"

The recommended projection distance is about 8ft-10ft.

The image size depends on the distance between projector and screen, there may be 3% deviation among above listed data. Different settings cause various distances.

3. Install on the Ceiling

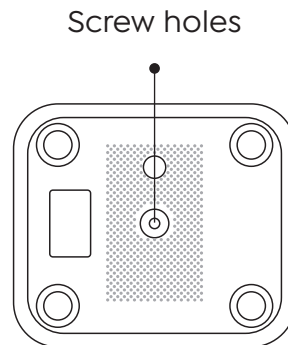
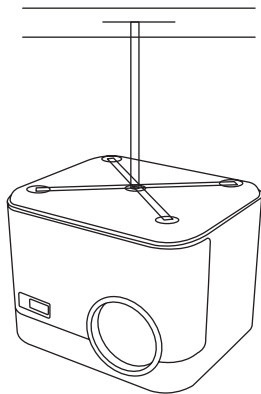

Note: Please purchase an universal projector ceiling mount, attach the projector with 1/4 inch screws.

Use The Projector

1. Turn on/off the projector

Connect the projector to the power supply, the projector will enter the standby state, and the signal indicator light on the cover will be red.

Power on: Press the power button on the body, or the power button on the remote control, and the indicator light turns blue to enter the working state.

Shutdown: In the working state, press the power button on the body, or the power button on the remote control, the indicator light will change from blue to red, and the projector will be turned off.

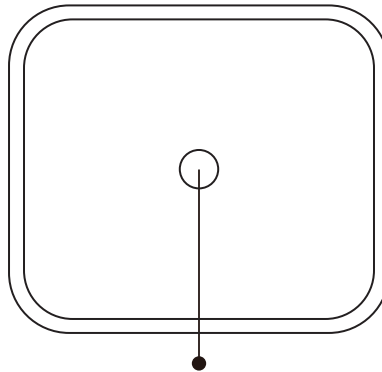

Power button

2. Focus Adjustment

* When starting the U11 projector for the first time, please wait patiently for 2-3 seconds, the projector will automatically adjust the focus. If the image is not clear, you can press the focus button "F+", "F-" to adjust the focal length of the lens, click or long press the focus button until the image is clear.

Note: If it's still blurry, try adjusting the throw distance.

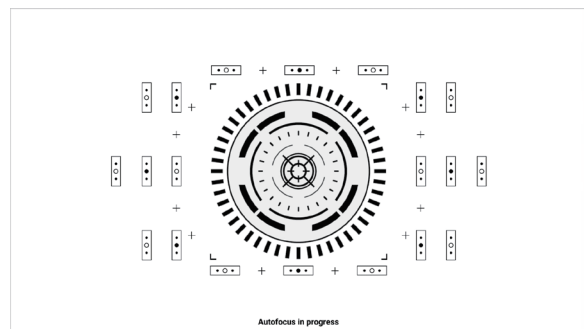

3. Keystone Correction Adjustment

* When the U11 projector is started for the first time, the projector will automatically perform keystone correction. Or you can also use the digital 4P keystone correction of the projector to change the image to be rectangle(vertical and horizontal). Detail please refer the page xxx of this manual.

Setting Up The Projector

The projector's home page is as follow.

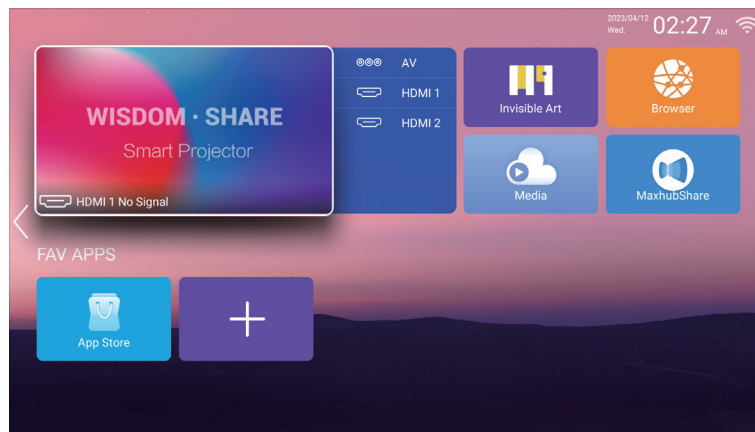

1. Select The Insert Signal Source

Select the desired insert signal source (AV/HDMI1/HDMI2) on the home -page.

Note: If you connect the external device (Such as TV box, Fire TV Stick, DVD Player, USB flash disk, Computer etc.), please must select the corresponding signal source. If you choose wrong, the projector will show no signal.

2. USB Disk Input Mode

2.1 Play Video/Audio/Image/Office in the USB Disk Input Mode

1. Insert the USB Disk, Select the icon [Media]
2. Select the option [All/Video/Audio/Image]
3. Select the desired file (or folder to enter the subfolder) in the USB disk, then press the [OK] button to play it.

Notice: Yaber U11 projector supports USB disk to directly play PPT, Word, Excel files.

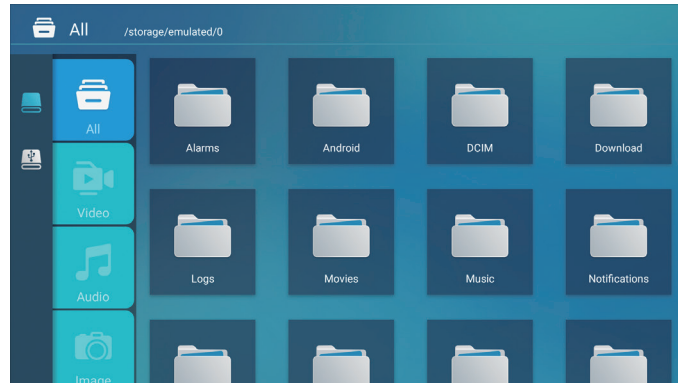

Warm Tips: If the projector cannot recognize the USB disk, please refer to the following methods to solve the problem.

Please confirm whether your USB disk meets the following formats.

1. FAT32: 8G/16G/32G
2. NTFS: 64G

If it is not, please format the USB disk. Before you format the USB disk, if you have anything on your USB disk, make sure to backup everything. After these steps, everything will be lost forever.

How to convert USB disk format to FAT32 format?

1. Plug-in your usb disk into the computers USB port.
2. Open up File Explorer and right-click on the drive.
3. Choose Format.
4. In the File System dropdown, please choose the FAT32 format.
5. Click Start and close this window when finished.

If the problem is still not solved, please send your problem to this email: **aftersales@yaber.com**

2.2 Play Interface

Click the "OK" button to get the play interface.

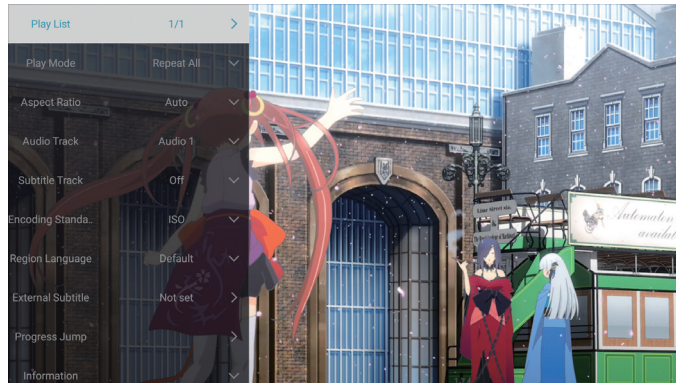

Playing setting	Include	Function
Play List	the videos of current folder	change video from the current folder
Play mode	repeat all, auto exit, repeat one, random, play list	change play mode
Aspect Ratio	auto, 16:9, 4:3, zoom1, zoom2	set video aspect ratio
Audio Track	audio track	set audio track
Subtitle Track	subtitle track	set subtitle track
Encoding Standard	iso, windows	set encoding standard
Region Language	various language	set region language
External Subtitle	external subtitle	choose subtitle from other folders
Progress Jump	progress jump	fast forward video to specific time
Information	resolution, size, duration, bitrate	see the basic video information
Picuture & Sound	piture and sound mode	set picture and sound mode

Menu	Content	Mode	Function
Picture Mode	Standard/Soft/ Dynamic/Vivid/User	Contrast	Modify the picture parameters in the range 0-100
		Brightness	
		Sharpness	
		Color	
Sound Mode	Standard/Music/ Moive/News/Users	Bass	Modify the sound parameters in the range 0-100
		Treble	

2.3 Music Play Interface

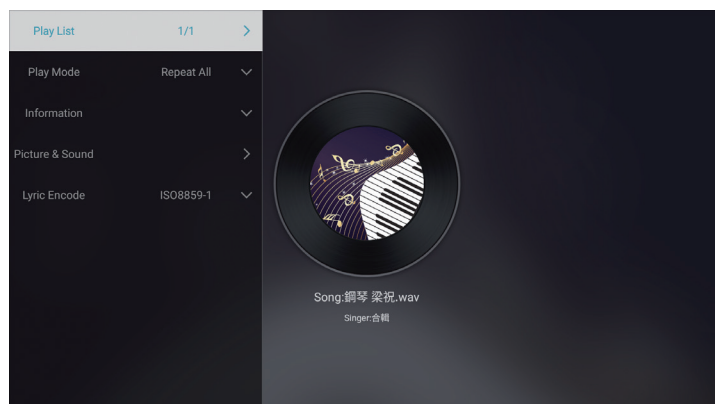

Playing setting	Include	Function
Play List	the musics of current folder	change music from the current folder
Play mode	repeat all, auto exit, repeat one, random, play list	change play mode
Information	size, duration, bitrate	see the basic music information
Picture&Sound	picture and sound mode	set picture and sound mode
Lyric Encode	various encoding standard	set encoding standard

2.4 Picture Play Interface

Playing setting	Include	Function
Play List	the pictures of current folder	change picture from the current folder
Play Slide	start, stop	start playing slides from the current folder
Interval Time	3 sec, 5 sec, 8 sec, 12 sec	set interval time of playing slides
Aspect Ratio	auto, full screen, zoom out, original, zoom1, zoom2	set picture aspect ratio
Rotate	default, rotate right, rotate left	rotate picture
Set as wallpaper	Set as wallpaper	Set as wallpaper
Information	resolution, size	see the basic picture information
Picture&Sound	picture and sound mode	set picture and sound mode

3. WiFi Setting

Wireless Connection

Warming Tips:

1. The fluency of screen mirroring with wireless connection will be affected by the network environment. A bandwidth of 100Mbit or more is recommended when using screen mirroring.
2. Make sure your mobile device is close to the projector when using wireless connection. A distance within 1 meter is recommended.
3. Some mobile devices may not support screen mirroring due to the compatibility.
4. Any questions, please feel free to contact us via **aftersales@yaber.com**.

3.1 iOS Cast (for iOS Devices)

1. Go to home page -- Press the left button - Select the [Network] menu - Select [Wireless Net Mode] - Select your home Wi-Fi from the list - Connect the Yaber U11 projector to your home Wi-Fi

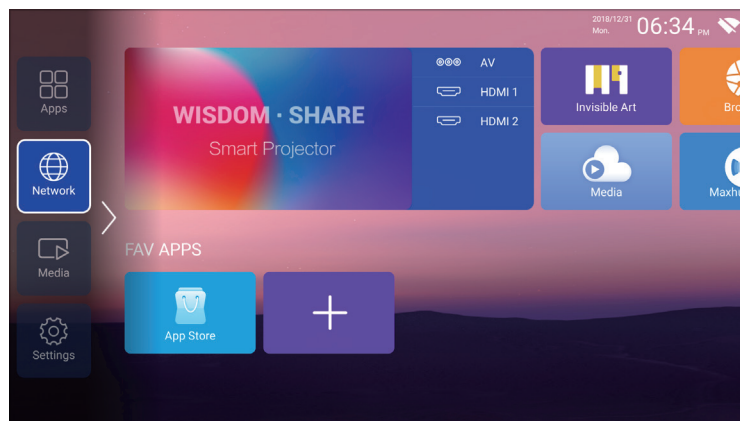

2. Select the [Settings] menu on your iOS device - Turn on the [Wi-Fi] function - Connect your iOS device to the same home network as the projector.
3. Open the [Control Center] on your iOS device - Select the [Screen Mirroring] function - Select and connect the iOS Cast receiver named [TV-XXXX] - your iOS device screen will be displayed on the projection screen after 3 seconds.

3.2 Maxhub Share (for Android Devices)

1. Make sure Yaber U11 projector and your Android device are connected with the same Wi-Fi, operations refer to the [1] and [2] from iOS Cast (for iOS Device)
2. Go to home - Select the [Maxhub Share] app - Press the OK button to enter the [Maxhub Share] app.

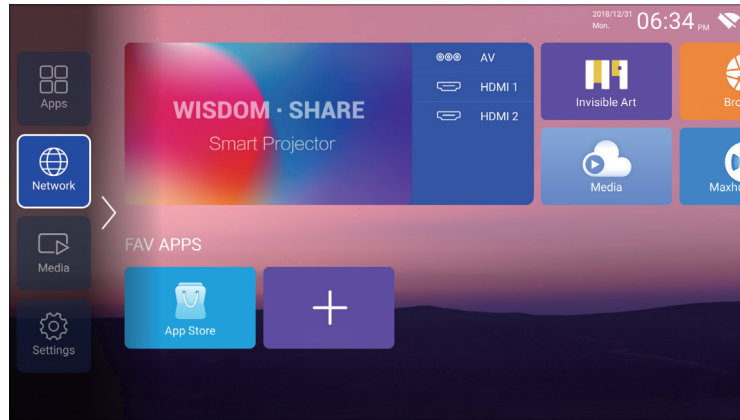

3. Scan the QR code and download the app on your Android device

4. Open [Maxhub Share] app on your Android device - Select TV named [TV-XXXX] -Your Android device screen will be displaced on the projection screen after 3 seconds.

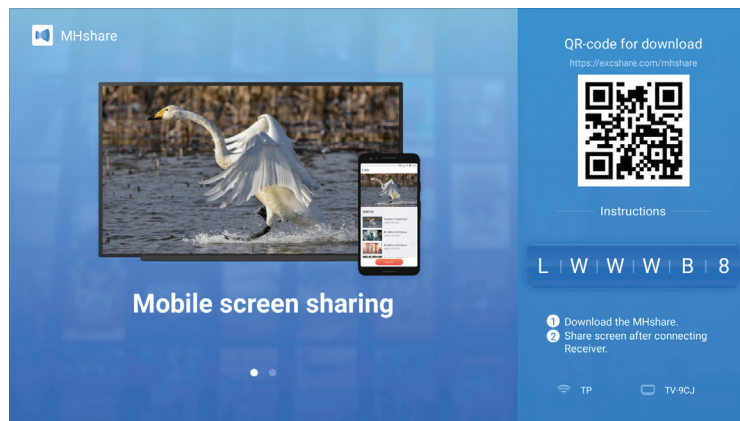

Note:

1. Different brands of Android phones have different operations for select Screen Mirroring Display, please refer to your phones manual. [Multiscreen/Wireless display/WLAN display/Screen mirroring/Wireless projection/Smart view etc.]

2. Not all Android phones support this function. Please make sure it is supported before use.

4. Bluetooth Setting

Go to home page - - Select the [Setting] menu - - Select the [Bluetooth] Option - - Open the Bluetooth function and your Bluetooth device - - Scan the Bluetooth devices nearby automatically - - Choose the Bluetooth device desired - - it will be paired and connected automatically.

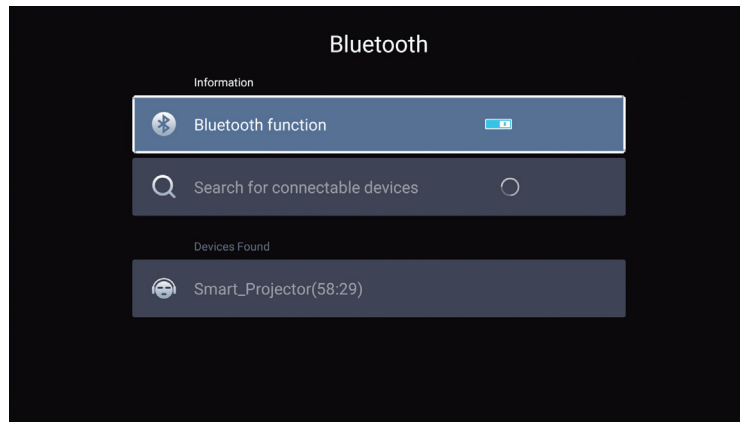

Note:

1. The Yaber U11 projector is compatible with the Bluetooth headsets, Bluetooth speakers and Air Pods, but not the Bluetooth keyboards or Bluetooth phones.
2. If you have any question, please feel free to contact us via **aftersales@yaber.com**.

5. Projector System Setting



5.1 Projection Mode

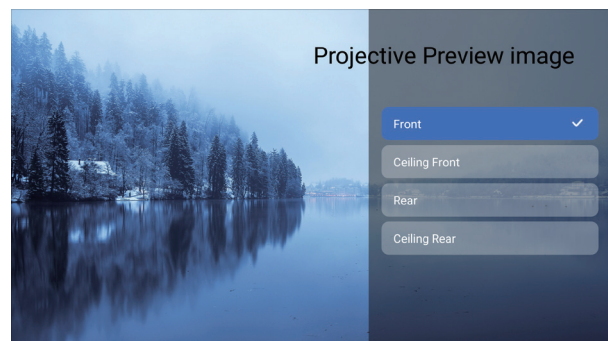
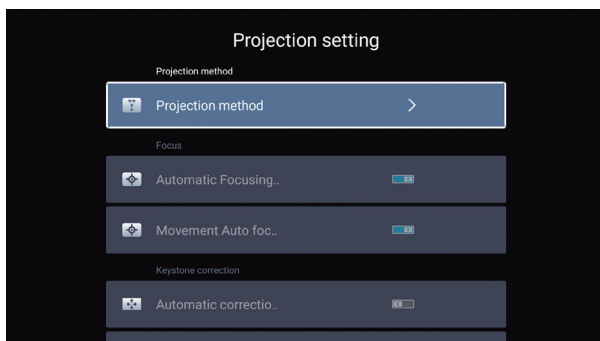

5.2 Focus

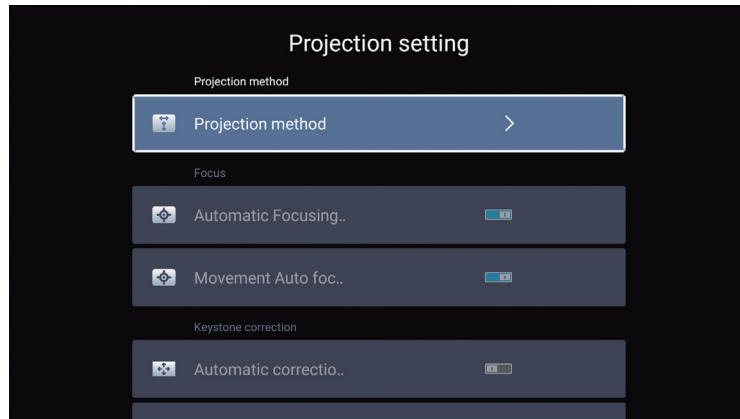

5.2.1 Automatic Focusing after boot

Turn on this button, when you start the projector, please wait patiently for 2-3 seconds, the projector will automatically focus after powering on.

5.2.2 Movement Auto focus

Turn on this button, the projector will automatically focus when changing the position.

Notice:

1. Use autofocus when you are setting up your projector or when you need to quickly adjust the focus of your image.

2. Use manual focus mode when you need more precise control over the focus of your image. Long press the focus button "F+", "F-" until the image is clear.

5.3 Keystone Correction

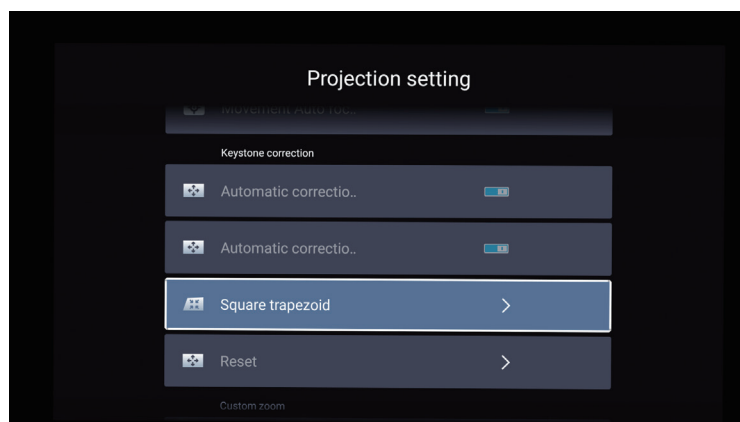

5.3.1 Automatic Correction after boot

Turn on this button, when you start the projector, please wait patiently for 2-3 seconds, the projector will adjust keystone automatically.

5.3.1 Automatic Correction after boot

Turn on this button, when you start the projector, please wait patiently for 2-3 seconds, the projector will adjust keystone automatically.

5.3.2 Automatic Correction after displacement

Turn on this button, the projector will automatically keystone correction when changing the position.

Notice: If you are not satisfied with the automatically corrected image, the projection screen is not rectangular, you can adjust it by 4-point keystone correction.

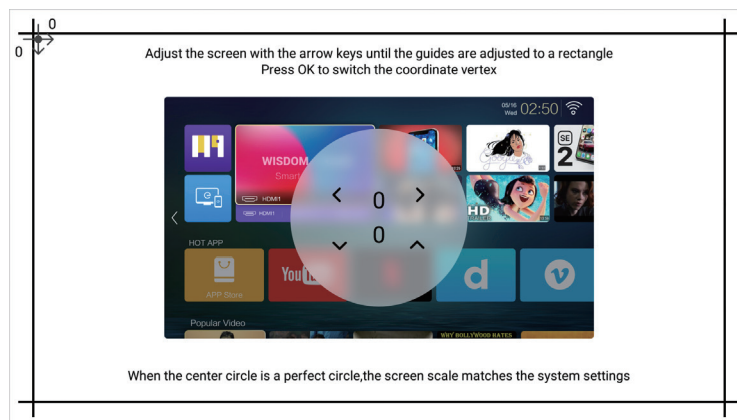

5.4 Zoom

* Select the [Custom Zoom] option, press the "OK" button on the remote controller to enter the submenu [Scale scaling], press the "OK" key to select this button to enter a three-level menu [Zoom], you can adjust the projection size by adjusting the parameters, zoom range is 50%–100%.

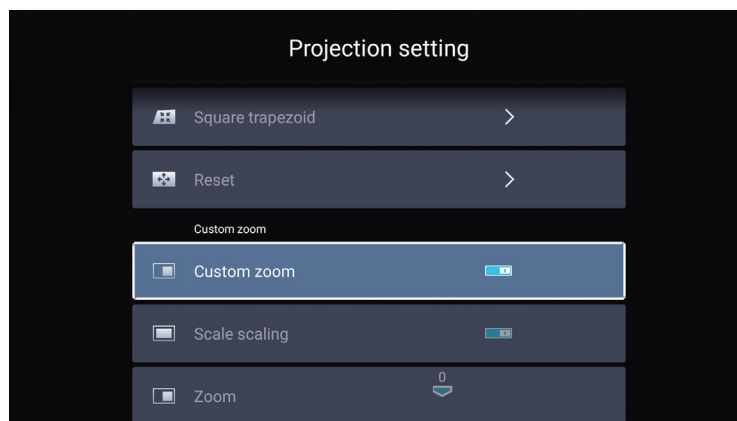

6. System Update

Go to home page - - Select the [Setting] menu - - Select the [System Info] Option - - Select the [System Upgrade]

Notice: If the software currently is the latest, you do not need to upgrade the software. During the upgrade process, if you have any question, please feel free to contact us via **aftersales@yaber.com**.

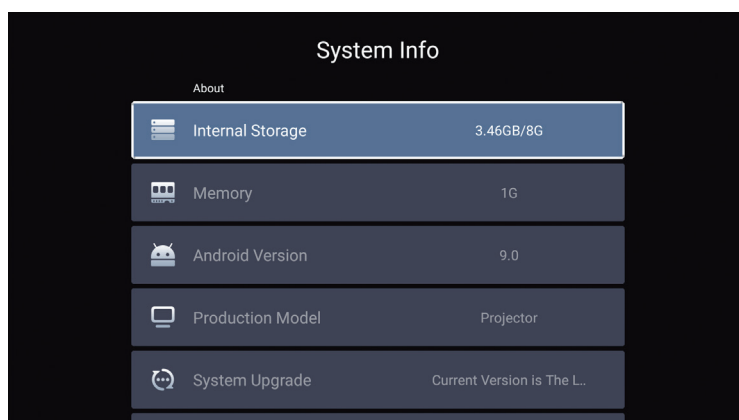

7. Common

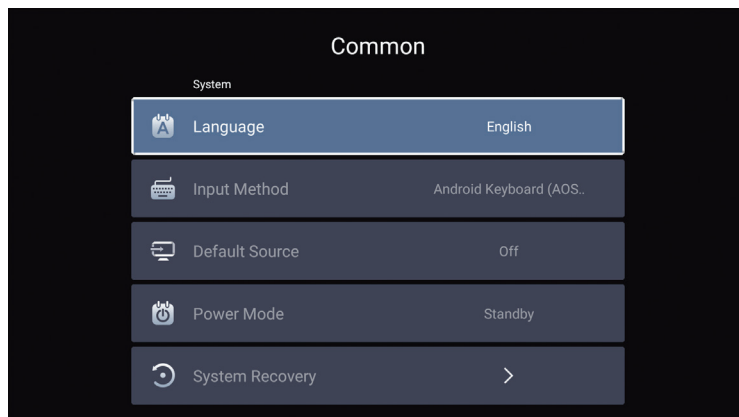

Menu	Function
Language	Set up system language
Input method	Set current input method
Wallpaper	Change wallpaper
Default source	Set up default source: AV, HDMI1, HDMI2
Power mode	Set power mode: standby, on, last
System Recovery	Recover the system and all data
The device name	Change projector name

Signal Lines Connection

Yaber U11 projector has 7 interfaces, HDMI port*2/ USB port*2/ 3.5mm headphone output*1/ Network port*1/ AV port*1, please select the correct port to connect your device (PC, DVD Player, Fire TV stick, TV box, Sound bar, USB disk, PS4 etc.)

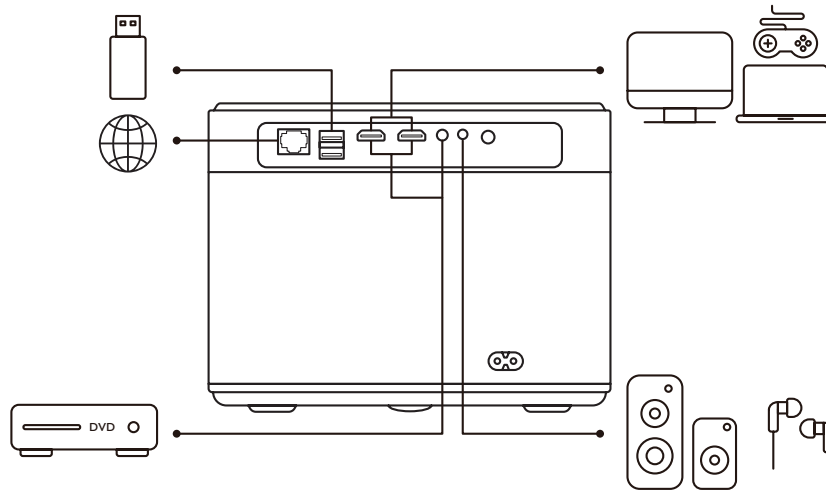

1. Connect the Devices via the HDMI ports

1. Connect your Fire TV stick (or PC, TV box, PS4 etc.) to the HDMI port of the projector;
2. Enter the home page to select the corresponding HDMI as the signal source.

2. Connect to the DVD Player

1. Turn on your DVD player and the projector.
2. Connect to the DVD Player and the projector with the HDMI cable.
3. Enter the home page to select the corresponding HDMI as the signal source.

Note: When the projector is connected to the DVD player via the HDMI cable, if there is no sound, it may be that the output signal of the HDMI port of the DVD player is not compatible with HDCP, please try to connect your Sound bar/Speaker.

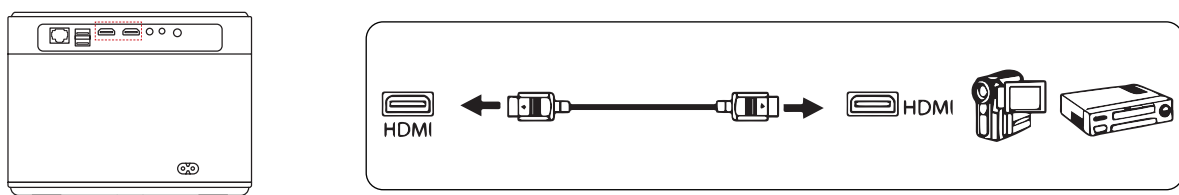

3. Connect to the Sound bar/Speaker

If your speaker has AUX port, please use your 3.5mm audio cable connect the projector and your speaker as the picture shows.

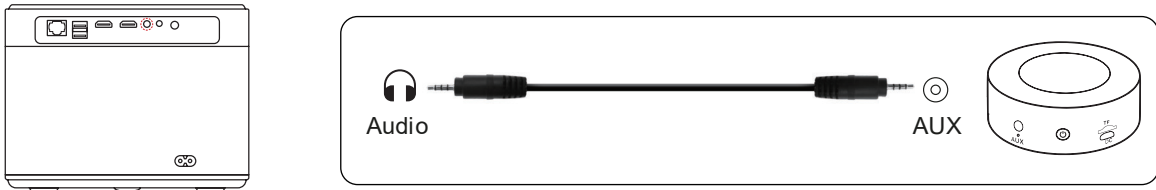

4. Connect to the Computer

1. Connect to the computer and U11 projector with the HDMI cable (Included).
2. Select the HDMI source to project any files on your computer;
3. On your laptop, hold down the key “Win+P” board keys to change your display mode.



Computer only: it is the default option – only displays on the main monitor.

Duplicate: makes all of the monitors display the same thing duplicating the desktop on each monitor.

Extend: makes all of your monitors act like one big monitor extending the desktop across all of them.

Projector only: Displays only on the secondary monitor like a projector.

You can change the screen resolution on the Projector Only Mode

Step: Start > Control Panel > Appearance and Personalization > Adjust Screen Resolution

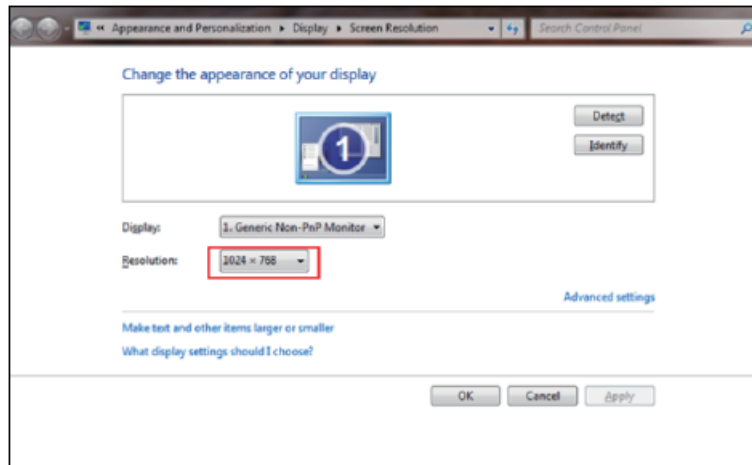

Warranty

Thank you so much for your purchase and support. We provide 3-year warranty for U11 projector. If you have any questions, please feel free to contact us via **aftersales@yaber.com**

FCC STATEMENT :

This device complies with Part 15 of the FCC Rules. Operation is subject to the following two conditions:

This device may not cause harmful interference, and

This device must accept any interference received, including interference that may cause undesired operation.

Warning: Changes or modifications not expressly approved by the party responsible for compliance could void the user's authority to operate the equipment.

NOTE: This equipment has been tested and found to comply with the limits for a Class B digital device, pursuant to Part 15 of the FCC Rules. These limits are designed to provide reasonable protection against harmful interference in a residential installation. This equipment generates uses and can radiate radio frequency energy and, if not installed and used in accordance with the instructions, may cause harmful interference to radio communications. However, there is no guarantee that interference will not occur in a particular installation. If this equipment does cause harmful interference to radio or television reception, which can be determined by turning the equipment off and on, the user is encouraged to try to correct the interference by one or more of the following measures:

Reorient or relocate the receiving antenna.

Increase the separation between the equipment and receiver.

Connect the equipment into an outlet on a circuit different from that to which the receiver is connected.

Consult the dealer or an experienced radio/TV technician for help.

FCC Radiation Exposure Statement:

This equipment complies with FCC radiation exposure limits set forth for an uncontrolled environment. This equipment should be installed and operated with minimum distance 20cm between the radiator & your body.

This device contains license-exempt transmitter(s)/receiver(s) that comply with Innovation, Science and Economic Development Canadas license-exempt RSS(s). Operation is subject to the following two conditions:

(1) This device may not cause interference.

(2) This device must accept any interference, including interference that may cause undesired operation of the device.

This equipment complies with IC exposure limits set forth for an uncontrolled environment. This equipment shall be installed and operated with minimum distance 20cm between the radiator & body.

Correct Disposal of this product



This marking indicates that this product should not be disposed with other household wastes throughout the EU. To prevent possible harm to the environment or human health from uncontrolled waste disposal, recycle it responsibly to promote the sustainable reuse of material resources. To return your used device, please use the return and collection systems or contact the retailer where the product was purchased. They can take this product for environmentally safe recycling.

Declaration of Conformity

We (EU based importer is responsible for this declaration)

Prolinx GmbH
(Company name)

Brehmstr.56, 40239 Duesseldorf, Germany
(Company address)

declare under our sole responsibility that the product

Trade name: Yaber

Equipment: Entertainment Projector

Model No. : U11

to which this declaration relates is in conformity with the essential requirement set out in the Council Directive on the Approximation of the laws of the Member States relating to RED Directive(2014/53/EU) & RoHS(2011/65/EU) product is responsible to affix **CE** marking, the following standards were applied:

EN 62368-1:2014+A11:2017
EN IEC 62311:2020
ETSI EN 301 489-1 V2.2.3(2019-11)
ETSI EN 301 489-17 V3.2.4(2020-09)
ETSI EN 301 489-3 V2.1.1(2019-03)
EN 55032:2015+A11:2020
EN 55035:2017 +A11:2020
EN IEC 61000-3-2:2019
EN 61000-3-3:2013+A1:2019
ETSI EN 300 328 V2.2.2(2019-07)
ETSI EN 301 893 V2.1.1(2017-05)
ETSI EN 300 440 V2.2.1(2018-07)
IEC62321-3-1:2013
IEC62321-4:2013
IEC62321-5:2013
IEC62321-6:2015
IEC62321-7-1:2015
IEC62321-7-2:2017
IEC62321-8:2017

Full Name: George.wang Position: Approbation Manager

Signature:  Place/Date: Shenzhen,China/Mar.22-2022



Scan and download the PDF user manual

Where to Get More Help

✉ Support@yabertech.com ✉ aftersales@yaber.com 🌐 www.yaberglobal.com

▶ [@Yaber Entertainment Projector](#) 📘 [@Yaber Entertainment Projector](#)