



UTE TUB RACK USER MANUAL

Please read this manual carefully before installation, and retain it for future reference.

V1.1



ABOUT US

Founded in 2018, the San Hima brand stands for passion and enthusiasm for exploring the spectacular nature of the great outdoors. Since its inception, the trusted solutions and proven designs that San Hima offers to the market have made adventure and travelling flexible and enjoyable!

Based in Australia, San Hima has under its umbrella a wide selection of outdoor solutions, including cargo systems, vehicle protection accessories and tow & trailer parts, that are designed to help you carry your gear wherever your passion takes you and boost your performance when conquering the peaks!

At San Hima, we have wild souls and we are committed to designing products that are tough enough to take on any adventures and at the same time, making them safe and easy to use. These values in our conviction are what drive us to make innovations. Since pursuit your passion shouldn't be complicated.

Live the Peak, Conquer the Everest, San Hima is your brand of choice!

IMPORTANT INFORMATION

- The accompanying user manual for this UTE tube rack contains crucial information regarding installation, operation, and loading.
- San Hima strongly advises reading the manual carefully before using the product, particularly the safety instructions and warnings. Failure to do so could result in personal injury, damage to the product or your vehicle. San Hima cannot be held responsible for damage or accidents caused by non-compliance with the safety instructions, modifications to parts, or the use of non-San Hima original parts.
- San Hima has made every effort to ensure the accuracy of this manual. However, it is impossible to cover every condition and situation that may arise, so it is the user's responsibility to exercise common sense and caution. You are also responsible for sharing these instructions with any third party who will be using this UTE tube rack, including in the case of second-hand sales. San Hima reserves the right to change this product at any time without prior notice.



WARNINGS AND SAFETY INSTRUCTIONS

GENERAL GUIDELINE

- The user must ensure that all accessories are properly secured to the rack before driving. It is crucial that you do not load the rack beyond the safe capacity of your vehicle. Refer to your vehicle's owner's manual for load ratings and installation recommendations for this UTE tube rack.
- The static load rating of this product is 300kg, and the dynamic rating is 200kg (evenly distributed). It is important to distribute weight evenly and avoid sudden load movements, which may create excess load and lead to product failure. A "distributed load" refers to a load that is spread out and not concentrated in a small area.
- Modifying or using this product for unintended purposes voids the warranty and may result in hazardous conditions that can cause property damage, serious bodily injury, and even death. San Hima disclaims all liability for injuries to persons or property resulting from any modification or unintended use of the product.
- The installation and use of the UTE tube rack may cause minor aesthetic damage to the exterior of your vehicle. San Hima does not make any claims or warranties regarding the ability of any particular vehicle to support rail-mounted accessories without incurring damage.
- This rack is intended solely for transporting recovery tracks, fuel tanks, water tanks, tents, farm jacks, awning tents, spare tires, and similar items that are safe to transport.
- Ensure that all adjustable parts are properly positioned for maximum support. Improper installation may reduce the capacity and stability of the product.
- Regularly inspect the rack for signs of damage or wear to ensure a high level of safety. If you notice any visible damage to any part of the rack, do not use it. Instead, contact San Hima for assistance.

INSTALLATION SAFETY

- It is essential to follow the instructions carefully when installing the product. Improper installation can create hazardous conditions.
- Before beginning installation, park your UTE on a flat, level, hard surface away from traffic. Shift the vehicle to park or neutral gear and engage the parking brake.
- Before drilling or driving screws, ensure that the installation surface is free of any hidden wires. Wear safety goggles and work gloves during assembly and installation.
- San Hima recommends that you consult your carmaker for guidance on installing the San Hima UTE tube rack.
- Maintain a clean and well-lit installation area, and keep bystanders away during installation.
- Do not attempt to install the product when you are tired or under the influence of drugs or medication.



DRIVING SAFETY

- Always exercise caution when driving with accessories mounted on the San Hima UTE tube rack. The added weight can alter the driving dynamics of your vehicle.
- Take note of the total vehicle height and width with the San Hima UTE tube rack and accessories mounted, and ensure safe passage under any low clearances.
- Before loading cargo or operating your UTE, verify that the San Hima UTE tube rack and accessories are mounted securely.
- Carrying a load above the rack will increase the center of gravity of your UTE, significantly affecting its ability to maneuver, turn, stop or accelerate. Avoid sharp turns and excessive speeds as these actions can increase the risks.
- When transporting wind-resistant loads, exercise extreme care for safety reasons. Special consideration should be taken when cornering and braking. Note for dealers and installers: It is your responsibility to provide instructions to the end-user or client.
- Check bolt connections at regular intervals to ensure their tightness.









LOADING SAFETY

- It is essential to tie down all loads securely to the rack to prevent them from vibrating, sliding, or being blown off by unexpected wind or road hazards.
- To avoid roll-over, ensure that loads are not top-heavy and transport high loads with extreme caution to prevent striking low overhead objects or tipping during turns, abrupt stops, or high winds.
- Keep the center of gravity as low as possible to maintain stability.
- Regularly check secured loads and connections for tightness to prevent damage and alteration of the vehicle's handling and braking characteristics or rollover.
- Follow local regulations and laws to secure loads according to height and identification requirements.
- Failure to secure cargo or hauling inappropriate cargo may result in severe injury or death.

INSPECTION AND MAINTENANCE

- Regularly inspect all components for signs of wear or damage. Check for loose bolts and parts, and tighten as necessary.
- Replace any parts that are damaged or worn. It's important to perform inspections and maintenance as soon as any malfunctions are observed or suspected.
- If you need help inspecting or servicing your UTE tube rack, please don't hesitate to visit our customer center.

INCLUDED PARTS & HARDWARE

1 PC(s) Tailgate & 2 PC(s) LED Auxiliary Lights		1 PC(s) Red Bottom Plate	
1 PC(s) Side Plate		4 PC(s) 2-hole Washer Plates	
6 PC(s) Side & TOP Beams		4 PC(s) Washer Plates	
4 PC(s) Upper Legs		1 PC(s) User Manual	
4 PC(s) Lower Legs			

2 PC(s) M6*20 Hex Socket Button Screws	12 PC(s) M10 Flat Washers
8 PC(s) M6*16 Hex Socket Cap Screws	10 PC(s) M6 Hexagon Nuts with Flange
76 PC(s) M8*30 Hex Socket Button Screws	76 PC(s) M8 Hexagon Nuts with Flange
8 PC(s) M10*80 Hexagon Head Bolts	12 PC(s) M10 Hexagon Nuts with Flange
4 PC(s) M10*40 Hexagon Head Bolts	10 PC(s) M6 Spring Washers
10 PC(s) M6 Flat Washers	76 PC(s) M8 Spring Washers
76 PC(s) M8 Flat Washers	12 PC(s) M10 Spring Washers

DIMENSIONS

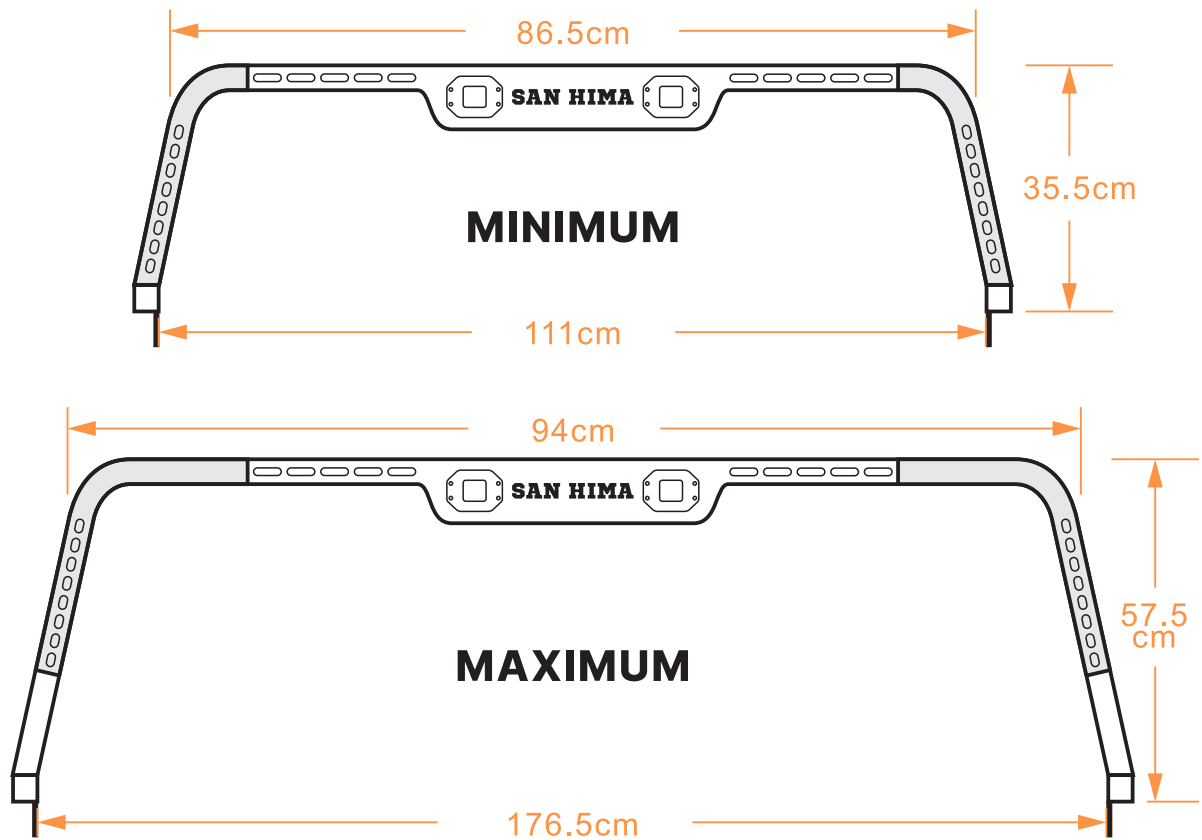

ASSEMBLY

It is advisable to construct the basic structure on a level surface prior to mounting it on your UTE. This approach enables you to facilitate installation at a lower height and subsequently make modifications to suit your specific needs.

- A: Tailgate
- B: Side Plate
- C: Top Beam
- D: Side Beam
- E: Upper Leg
- F: Lower Leg

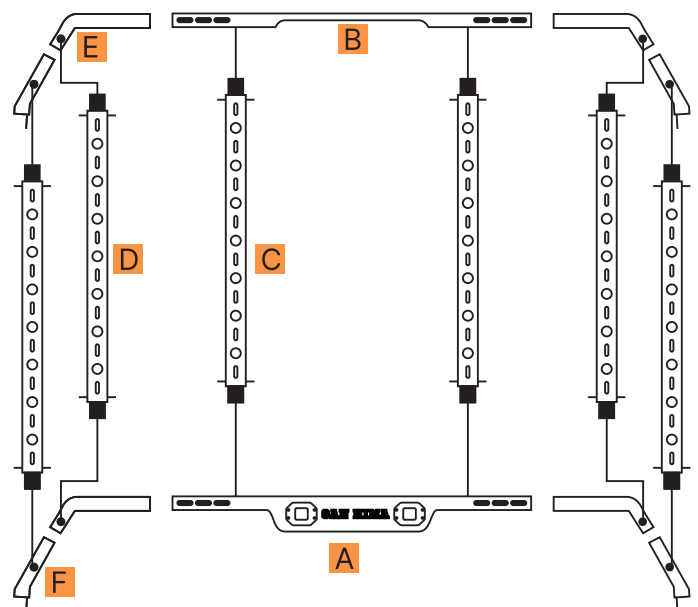

1. PREPARATION

Upon opening the box, arrange all parts neatly. Additionally, ensure that you have the following tools on hand:

- 10mm Wrench
- 8mm Wrench
- 6mm Wrench
- 8mm Hex Key
- 6mm Hex Key

2. ASSEMBLE THE UTE TUBE RACK

Step 1: Begin by fastening the upper legs (E) and lower legs (F) together using M8 hex socket button screws, but avoid tightening them completely at this stage. Keep in mind that adjustments may be necessary once the assembled rack is installed on the UTE.



STEP 2. Insert M6 hex socket cap screws into the tailgate to fasten the LED auxiliary lights (refer to the picture below). Next, use M6 hex socket button screws to secure the tailgate (A) and the red bottom plate.



STEP 3: Adjust the rack to match the width of your UTE bed, and use M8 hex socket button screws to attach the finished assembly from steps 1 and 2. However, please do not insert screws on the opposite side at this time.



STEP 4: Use M8 hex socket button screws, fasten the assembly from step 1 and the side plate, and adjust the assembly to fit the width of your UTE bed. Avoid inserting screws on the opposite side for now.



STEP 5: Install the side beams (D).

Please note that the washer plate should not be installed between the side beams (D) and upper legs (E).

However, it must be installed when assembling the side beams (D), upper legs (E), and lower legs (F) together, as indicated in the diagram below.

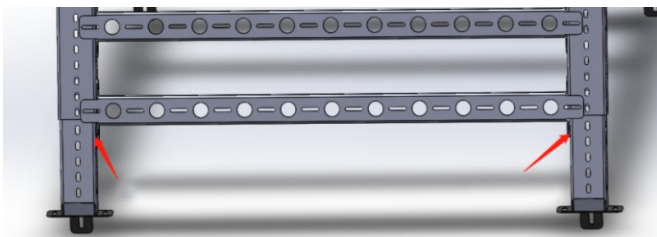

Additionally, when installing the side beams (D) and lower legs (F), please ensure the use of the 2-hole washer plate.

STEP 6: Install the lower leg (F).

STEP 7: Grab a buddy to place the rack on top of the tub in the desired position. Use a marker to mark the centre of the mounting holes of the lower legs (F). These are the drill holes for your rack.

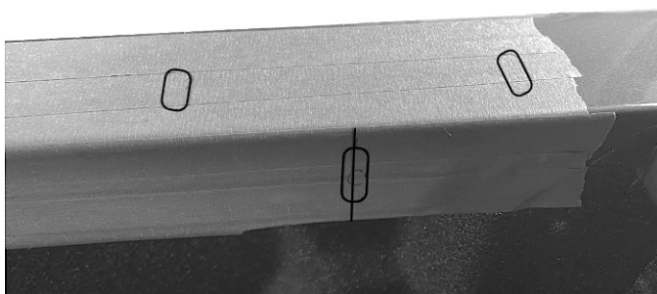

STEP 8: Once all holes are marked, remove the tub rack. Drill pilot holes on the previous marked positions. Then widen the holes.

STEP 9: Use a deburring tool to clean up the drilled holes and touch up the paint to prevent rust on the freshly drilled metal.

STEP 10: Once the paint is dry, the tub rack can be re-mounted. Attach 8x M10 x 80 bolts to the vertical holes drilled and 4x M10 x 40 bolts to the horizontal holes drilled into the tub. Tighten all bolts, nuts, and washers securely on each leg of the tub rack, and remember to use flat washers to distribute the load of the bolts.

STEP 11: Make sure to tighten all screws properly to complete the installation.



WARRANTY

San Hima ("Manufacturer") warrants to the original purchaser ("User") that its UTE tube rack, if purchased from the manufacturer or an authorized distributor or dealer, will be free from defects in material and workmanship under normal usage from the date of sale and for a duration of one year (the "Warranty Period").

This warranty is only effective for the original purchaser and applies solely to the San Hima UTE tube rack that is correctly installed on the vehicle. San Hima will either replace the product or provide a refund at its discretion provided that the fault is found to have been caused by a design or manufacturing defect that results in its failure to perform correctly as described.

This limited warranty is the only warranty that applies to this product, and it sets forth all the responsibilities of San Hima. No labor or service allowance is given or implied. San Hima shall not be liable for incidental, consequential, or special damages or charges under any circumstances.

EXCLUSIONS:

This warranty does not cover defects, failures, or damages caused by incorrect installation or intentional damage. To avoid voiding the warranty, it is recommended that the installation should be performed by suitably qualified technicians. This warranty is also void if the UTE tube rack is:

- repaired, altered or modified by anyone other than San Hima or without San Hima's authorization,
- damaged by extreme weather, normal wear and tear, alteration, or failure to check the condition of the UTE tube rack before and during every journey,
- damaged by abuse, neglect, misuse, or as a result of an accident or any other cause,
- misapplied, overloaded, or improperly installed.

CLAIMS:

For any claims related to a potentially defective San Hima product, the user must provide proof of purchase, such as a screenshot of the order, as well as a picture and video of the damaged product, in its entirety, to sales@sanhima.com. If San Hima determines that the product is indeed defective and covered under the terms of this limited warranty, San Hima will either replace the product or provide a refund, at its discretion.