

AC POWERED CHARGER



Owner's Manual Rev: 5.5 (2023)

EN31220 - Charger 12V / 20Amp

EN31240 - Charger 12V / 40Amp

EN31260 - Charger 12V / 60Amp

EN312100 - Charger 12V / 100Amp

EN32430 - Charger 24V / 30Amp

Please Keep This Manual For Future Reference

For safe and optimum performance, the Enerdrive Battery Charger must be used properly. Carefully read and follow all instructions and guidelines in this manual and give special attention to the CAUTION and WARNING statements.

Disclaimer

While every precaution has been taken to ensure the accuracy of the contents of this guide, Enerdrive assumes no responsibility for errors or omissions. Note as well that specifications and product functionality may change without notice.

Important

Please be sure to read and save the entire manual before using your Enerdrive Battery Charger. Misuse may result in damage to the unit and/or cause harm or serious injury. Read manual in its entirety before using the unit and save manual for future reference.

Product Numbers - Battery Charger Series

EN31220	Battery Charger 12V / 20Amp
EN31240	Battery Charger 12V / 40Amp
EN31260	Battery Charger 12V / 60Amp
EN312100	Battery Charger 12V / 100Amp
EN32430	Battery Charger 24V / 30Amp

Battery Charger Owners Manual Rev. 5.5. This Manual is applicable to all units with serial number prefix EN.

Service Contact Information

Dometic Power & Control (Enerdrive) Pty Ltd

PO Box 9159, Wynnum Plaza, QLD 4178

Ph: 1300 851 535 / Fax: 07 3390 6911

Email: support@enerdrive.com.au | Web: www.enerdrive.com.au

Notice of Copyright

Enerdrive Battery Charger owner's manual © 2023 Enerdrive. All rights reserved. No part of this document may be reproduced in any form or disclosed to third parties without the express written permission of Dometic Power & Control (Enerdrive) Pty Ltd. Enerdrive reserves the right to revise this document and to periodically make changes to the content hereof without obligation or organisation of such revisions or changes, unless required to do so by prior arrangement.

Exclusions For Documentation And Product Usage

1. Unless specifically agreed to in writing, Dometic Power & Control (Enerdrive) Pty Ltd: makes no warranty as to the accuracy, sufficiency or suitability of any technical or other information provided in its manuals or other documentation.
2. Assumes no responsibility or liability for losses, damages, costs or expenses, whether special, direct, indirect, consequential or incidental, which might arise out of the use of such information. The use of any such information will be entirely at the user's risk.
3. Reminds you that if this manual is in any language other than English although steps have been taken to maintain the accuracy of the translation, the accuracy cannot be guaranteed.
4. Makes no warranty, either expressed or implied, including but not limited to any implied warranties of merchantability or fitness for a particular purpose, regarding these Enerdrive products and makes such Enerdrive products available solely on an "as is" basis.
5. Shall in no event be liable to anyone for special, collateral, incidental, or consequential damages in connection with or arising out of purchase or use of these Enerdrive products. The sole and exclusive liability to Enerdrive, regardless of the form of action, shall not exceed the purchase price of the Enerdrive products described here in.

Table of Contents

1. INTRODUCTION.....	6
2. PRODUCT DESCRIPTION.....	8
3. UNDERSTANDING THE UNIT.....	9
Multistage Charging Process.....	12
Smart Charging Feature.....	13
Battery Charger Voltage.....	16
Battery Bank Size Recommendation.....	16
4. INSTALLING THE CHARGER.....	17
Mounting The Charger.....	18
Chassis Grounding Connection.....	19
DC Output Wiring.....	19
Recommended Cable Length, Size And Required Fuse Size.....	19
Standard Temperature Sensor Connection.....	20
Optional Remote Display Connection.....	20
Running The Battery Charger With Portable Generators.....	21
Battery Wiring: Connecting The Batteries The Right Way.....	22
5. UNIT OPERATION.....	24
Understanding The Charging Mechanism.....	24
For Charging GEL, AGM And Flooded Batteries.....	24
For Charging Lithium Batteries.....	25

For Using Charger As Power Supply (Program Setting).....	25
Understanding The Display And Function Keys During Normal Operation.....	26
Understanding The Function Key 'MENU', 'SET' And 'SEL' During Charger Setting.....	26
Understanding The Three-Stage (Mode 3) Charging.....	26
Understanding The Two-Stage (Mode 2) Charging.....	26
Understanding The Battery Temperature Functions.....	27
Procedure To Set Or View Charger Setting.....	28
GEL, AGM Or Flooded Battery Type:.....	28
Lithium Battery Type.....	29
Program (Power Supply) Type.....	30
Procedure To Equalize Flooded Battery.....	30
Understanding The Silent Mode Function.....	32
Understanding The Protection Features.....	33
Charging A Dead Battery.....	33
Understanding The Error Codes.....	34
6. SPECIFICATIONS.....	35
7. WARRANTY.....	37
5 Year Warranty.....	37
8. Appendix 1.....	36
9. Appendix 2.....	38

1. INTRODUCTION

Thank you for purchasing the Enerdrive Battery Charger. With our state of the art, easy to use design, this product will offer you reliable service for providing a multistage, multi-bank battery charger to charge the different types of batteries you have installed in either your home, boat, caravan, 4WD or commercial vehicle. This manual will explain how to use this unit safely and effectively. Please read and follow these instructions and precautions carefully.

IMPORTANT SAFETY INFORMATION

This section contains important safety information for the Enerdrive Battery Charger. Each time, before using the Enerdrive Battery Charger, READ ALL instructions and cautionary markings on or provided with the Battery Charger, and all appropriate sections of this guide. The Enerdrive Battery Charger contains no user serviceable parts. Opening up the charger will void product warranty. See warranty section for how to handle product issues.



CAUTION

FIRE AND/OR CHEMICAL BURN HAZARD

Do not cover or obstruct any air vent openings and/or install in a zero-clearance compartment.



WARNING

SHOCK HAZARD. KEEP AWAY FROM CHILDREN!

Avoid moisture ingress. Never expose the unit to snow, water, etc.

**WARNING****FAILURE TO FOLLOW THESE INSTRUCTIONS CAN RESULT IN DEATH OR SERIOUS INJURY**

When working with electrical equipment or batteries, have someone nearby in case of an emergency.

Study and follow all the battery manufacturer's specific precautions when installing, using and servicing the battery connected to the charger.

Wear eye protection and gloves.

Avoid touching your eyes while using this unit.

Keep fresh water and soap on hand in the event battery acid comes in contact with eyes. If this occurs, cleanse right away with soap and water for a minimum of 15 minutes and seek medical attention.

Lead Acid Batteries produce explosive gases. DO NOT smoke or have an open spark or fire near the system.

Never attempt to re-charge a damaged, frozen or non-rechargeable battery.

Keep unit away from moist or damp areas.

Avoid dropping any metal tool or object on the battery. Doing so could create a spark or short circuit which goes through the battery or another electrical tool that may create an explosion.

Battery charger must be plugged in to an earthed and Australian Standards compliant outlet. If the unit's power cable is damaged, replace the cable immediately.



WARNING

DO NOT use the Enerdrive Battery Charger in the vicinity of flammable fumes or gases (such as gas bottles or large engines).

AVOID covering the ventilation openings. Always operate unit in an open and well ventilated area.

Prolonged contact to high heat or freezing temperatures will decrease the working life of the unit.



LIMITATIONS OF USE

Do not use in connection with life support systems or other medical equipment or devices.

Charger is not to be used by persons with reduced physical or mental capabilities or lack of knowledge and experience. Not to be operated or used by children.

2. PRODUCT DESCRIPTION

The Enerdrive Battery Charger package includes the items listed below:

- Battery Charger
- Battery Temperature Sensor (7.5 Meter Cable)
- IEC 240Vac Power Lead
- Owner's manual (Rev: 5.4) September 2021
- Appendix A1 rev 3 (see page 36 & 37 of this manual)
- Appendix A2 rev 3 (see page 39 & 39 of this manual)

3. UNDERSTANDING THE UNIT

The Enerdrive Battery Charger is a fully automatic multistage battery charger with the ability to charge three separate battery banks.

When first connected to an AC power source, the charger will check all three battery banks before charging commences. The Battery Charger operates on an isolated charging design where battery bank one is separate from battery bank two and three. Battery bank one is the priority battery bank in the charging sequence and must be connected to the primary house (or main) battery bank. Battery bank one can be programmed with a different charge algorithm over banks two and three.

Battery bank two and three are connected in parallel internally (with a separation diode) and share a common charge algorithm.

During normal operation the Battery Charger will do a full charge cycle to float stage on battery bank one with battery types set to either GEL, AGM, FLOODED or LITHIUM (see Lithium section for limitations of use). Once float stage is reached the charger transitions to charge banks two and three together with a bulk / absorption mode (battery banks two and three can be set to either GEL, AGM or FLOODED). The EN312100 allows for Lithium Batteries to be charged from all three outputs.

On completion all three battery banks move to float stage with a shared battery voltage determined by bank one settings. This setting allows the charger to remain permanently connected to mains if required.



CAUTION

Battery bank one should **ONLY** be connected to the main battery bank that requires charge priority. On single battery bank installations **DO NOT** use bank two and three charger outlets.

EN31220, EN31240, EN31260, EN32430

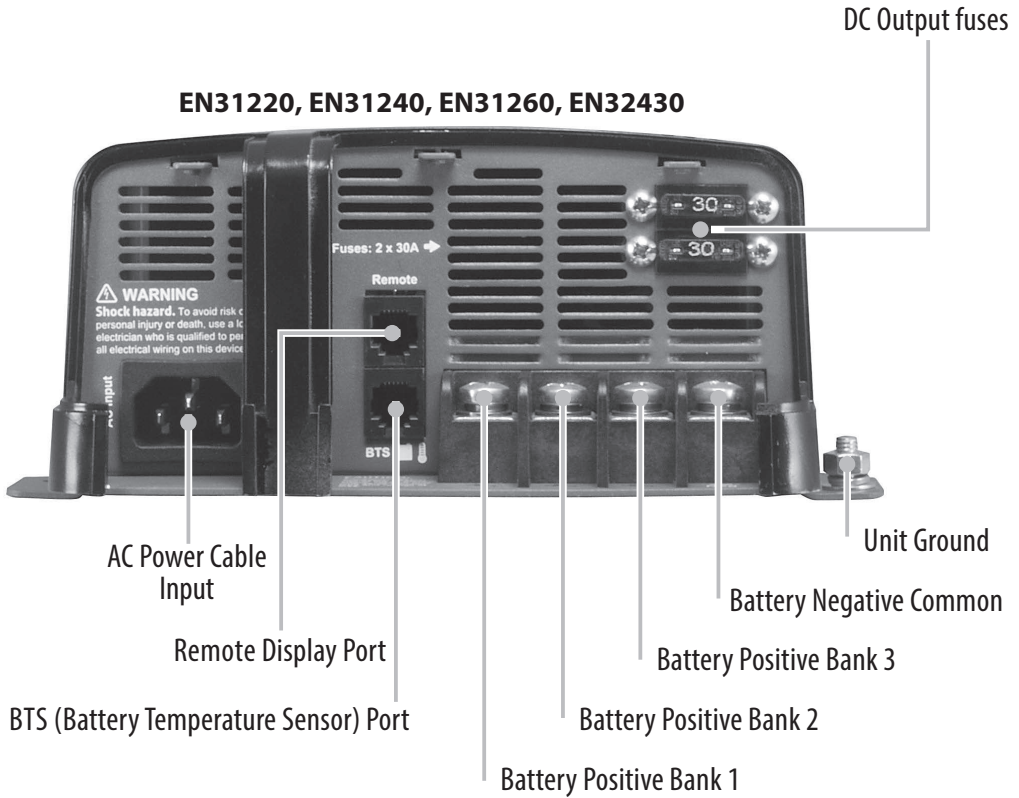

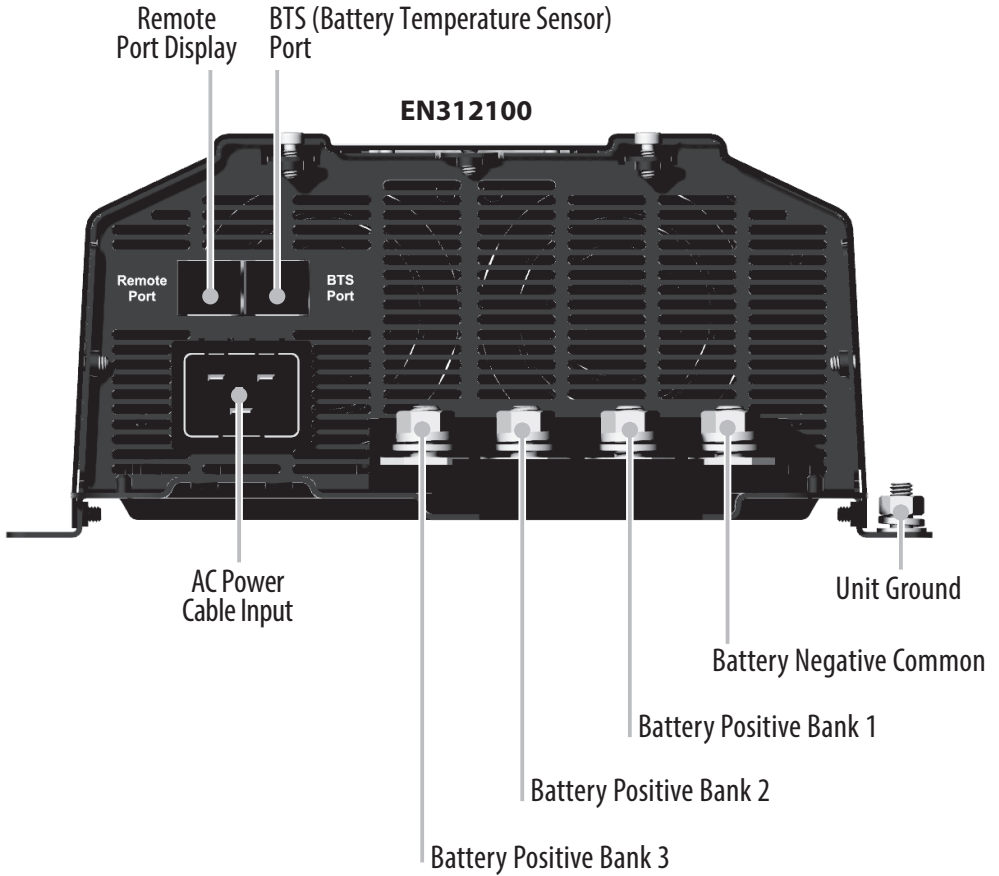

Multistage Charging Process for Lead Acid Batteries

The Battery Charger is a fully automatic, set and forget charger. It is designed to quickly and accurately recharge your deep cycle batteries utilising charger algorithms that help to maximise the life of your specialised deep cycle batteries.

These Battery Chargers feature multistage smart charging technology that enables the charger to be connected to your battery banks permanently.

The Battery Charger utilise high frequency power switching circuits to convert the normal mains 240 volts AC (via either shore or generator power), to the required low voltage DC required to charge the batteries. As dictated by battery manufacturer's recommendations, deep cycle batteries require a multistage charge sequence for perfect, fast and accurate charging. Enerdrive multistage smart chargers delivers four primary charge stages.

Stage 1 – Bulk or Boost charge; The battery is charged at full rated output current of the charger until the battery reaches its final charging voltage, known as its absorption voltage. In this step, around 80% of the battery is recovered as fast as possible.

Stage 2 – Absorption Charge; With the charger voltage held steady, the remaining 20% is replaced with the charger allowing the current to taper off as the battery approaches its full charge.

Stage 3 - Float, Finally, in the float stage the charger voltage is lowered and held at a constant and safe predetermined level. This prevents the battery from being overcharged, yet allows the charger to supply enough current to make up for the self discharge losses of the battery, while supporting any additional loads connected to the battery (such as DC lighting and refrigerators). This stage allows for the charger to be used as a DC power supply.

Stage 4 - Maintenance stage is a regular timed recharge (or return to bulk stage). The Enerdrive Battery Charger switches the charger from float to boost after 7 days of constant operation to ensure the battery banks remain active.

Smart Charging Feature

The Battery Charger will regulate its output based on the loads connected to your battery banks. This function is important to maintain the life of your battery banks as some battery chargers mistake loads for discharge and continue to keep the batteries in the bulk or absorption stage for extended periods of time, which will damage the battery bank. The Battery Charger has two methods of load based regulation to ensure your battery charger transitions to float when it should do so.

Battery Charger Algorithm

EN31220, EN31240, EN31260, EN32430

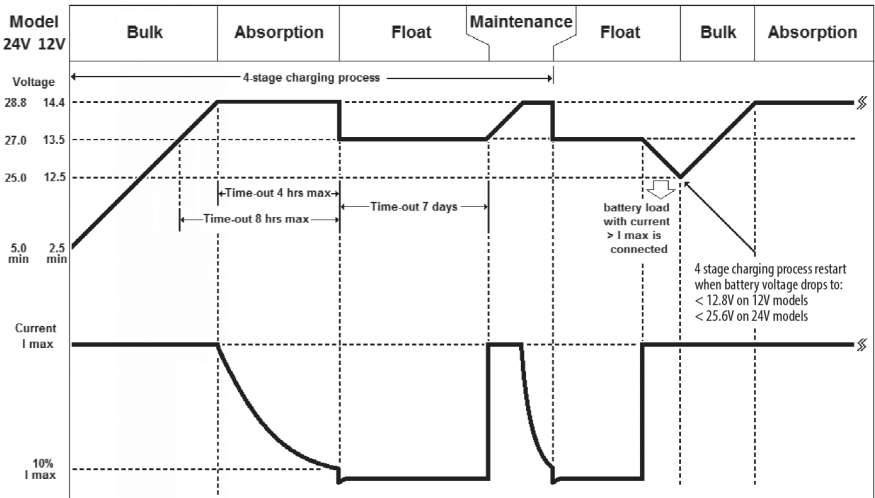

Lithium Battery charging algorithm

EN31220, EN31240, EN31260, EN32430

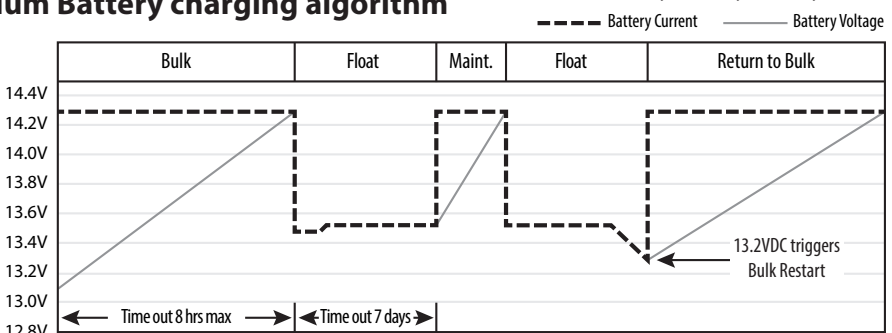
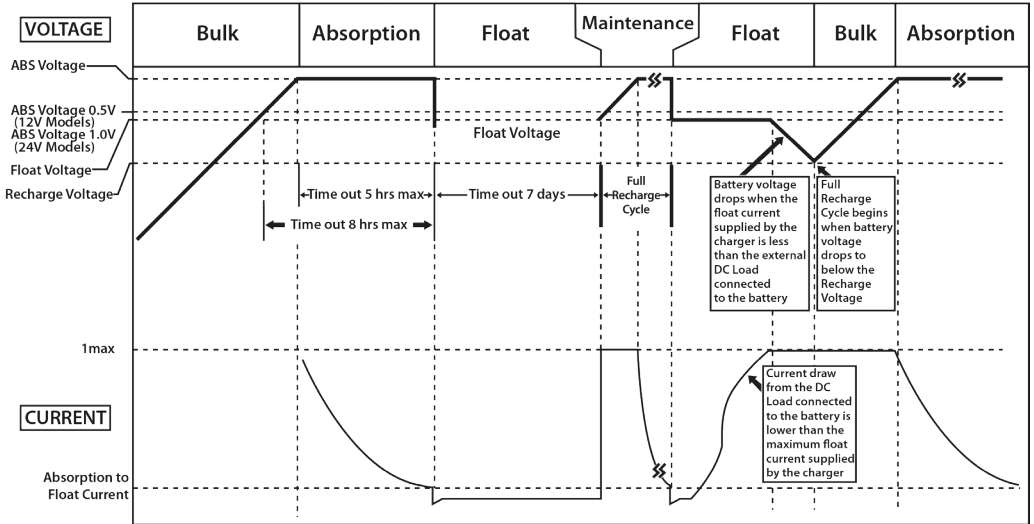

Diagram does not illustrate our current set points. Note: Actual voltages depend on chosen algorithm.

EN312100

GEL, AGM, Flooded and Program Battery Charging Profile



Lithium Battery Charging Profile

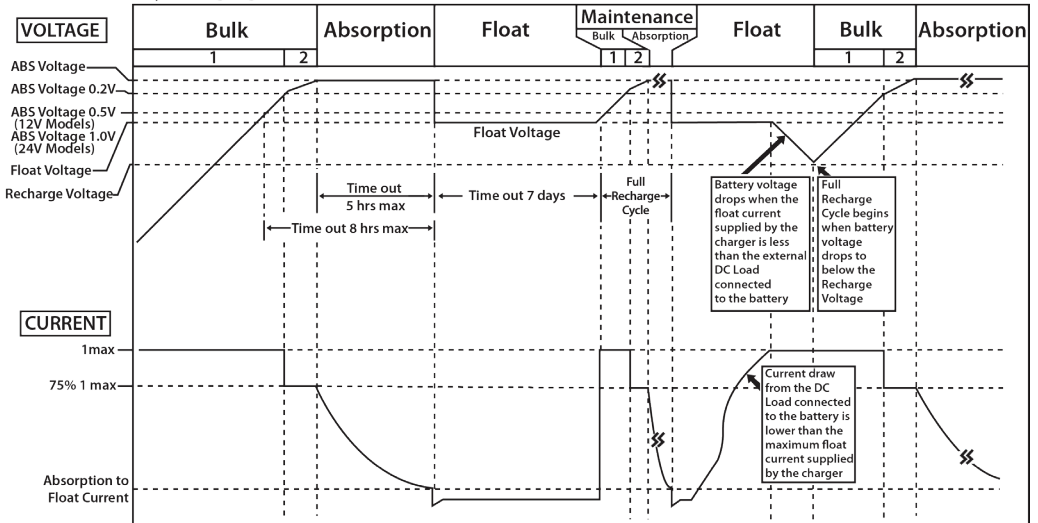

Note: Actual voltages dependent on chosen algorithm.

In the event of AC mains loss the charger will react according to time without mains power.

Loss of AC power for less than 4 min - Charge resumes at existing stage.

Loss of AC power for more than 4 min - Charge resumes at bulk stage. See page 29 for Lithium settings.

Example Of Actual 40Amp, 3 Bank Test Lead Acid Profile

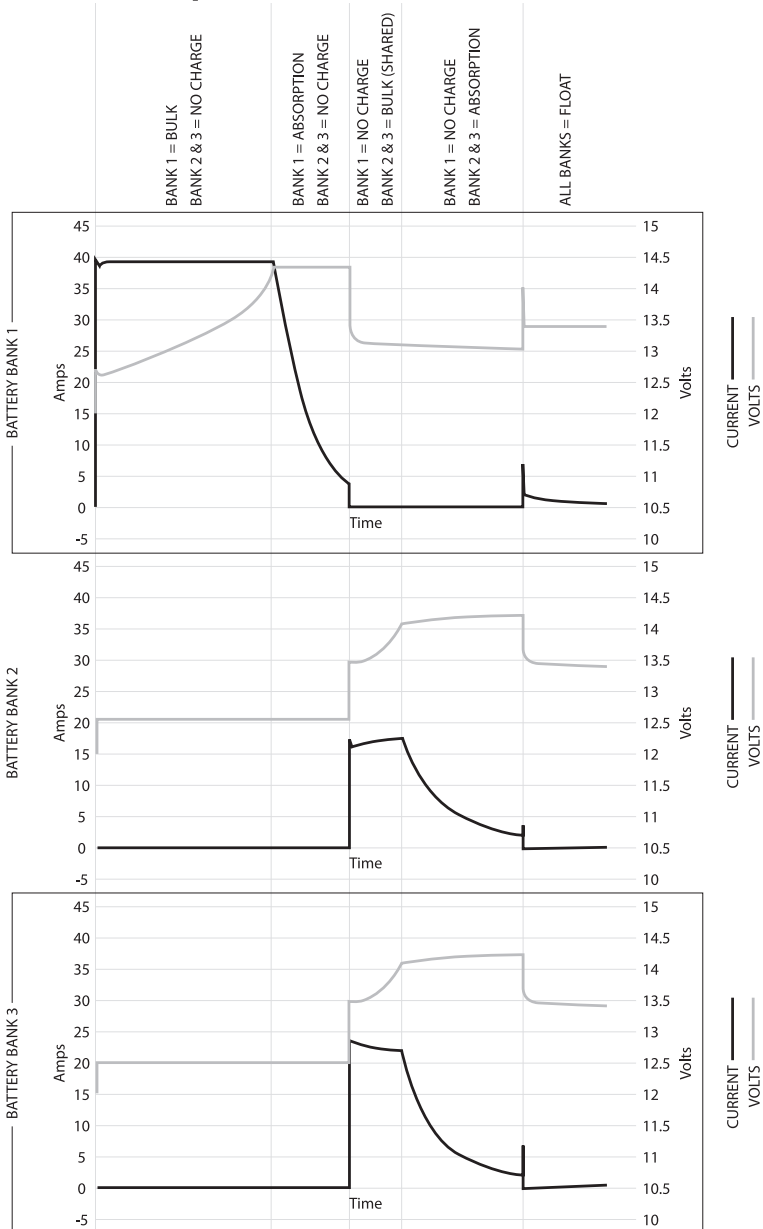

Battery Charger Voltage

Battery Type	Absorption	Float	Equalisation
GEL	14.4 V	13.7 V	N.A.
AGM	14.6 V	13.6 V	N.A.
Flooded	14.4 V	13.3 V	15.5 V (See Note1)
Lithium LiFeP04	Constant 13.9, 14.0, 14.1, 14.2, 14.3, 14.4, 14.5, 14.6 Volts (See Note2)		N.A
Program (Power Supply)	Constant 13.3, 13.5, 13.7 Volts (See Note3)		N.A

* For 24V model charger multiply above voltages by 2.

** For Concorde™ branded batteries (lifeline, sun x tender) use flooded setting and consult battery supplier for equalisation recommendations

Note 1: Equalisation setting can only be used on flooded battery type selection only. See more details on Procedure to Equalise the Flooded Battery.

Note 2: Charger will terminate charging when charging current drop to below the set charger termination value (L setting).

Note 3: Charger is acting as a power supply with selected constant output voltage and preset maximum output current. With this setting, only Bank 1 can be used, Bank 2 and 3 is disabled.

Battery Bank Size Recommendation

The battery charging current rating is based on the battery size. Each battery bank should meet the minimum Ah rating as shown. If a smaller size battery bank is used, set the current rating to lower value to match with the battery bank size. Normally, the minimum battery bank capacity is based on twice the charger current rating.

Note: Reference your Battery Manual for max charge current as this may differ

EN31220		EN31240		EN31260		EN312100		EN32430	
Current Setting	Battery Capacity	Current Setting	Battery Capacity	Current Setting	Battery Capacity	Current Setting	Battery Capacity	Current Setting	Battery Capacity
5A	Min 10Ah	5A	Min 10Ah	5A	Min 10Ah	40A	Min 80Ah	5A	Min 10Ah
10A	Min 20Ah	10A	Min 20Ah	20A	Min 40Ah	60A	Min 120Ah	10A	Min 20Ah
15A	Min 30Ah	20A	Min 40Ah	40A	Min 80Ah	80A	Min 160Ah	20A	Min 30Ah
20A	Min 40Ah	40A	Min 80Ah	60A	Min 120Ah	100A	Min 200Ah	30A	Min 60Ah

4. INSTALLING THE CHARGER



WARNING

Enerdrive recommends that all wiring be done by a skilled technician to ensure adherence to the best practice standards for on-board DC electrical installations. Failure to follow these instructions can damage the unit and could also result in personal injury or loss of life.



CAUTION

Before Beginning Your Unit Installation, Please Consider The Following:

The unit should be used or stored in an indoor area away from direct sunlight, heat, moisture or conductive contaminants. This is an electronic device cooled by a fan and will prematurely fail if installed in corrosive environments.

When placing the unit, allow a minimum of 75mm of space around the unit for optimal ventilation.



NOTE

The Enerdrive Battery Charger is designed to be permanently mounted.

Mounting The Charger

- Choose an appropriate mounting location.
- For installing in an indoor location, the unit can be mounted in any direction although mounting the charger vertically provides the best thermal performance.
- For installing in boat or marine environment, the unit can be mounted horizontally and vertically (AC and DC panel facing downwards only) to provide adequate drip protection.
- Use the base of the charger as a mounting template to mark the positions of the fixing screws.
- Drill the 4 fixing holes and place the charger in position and fasten the unit to the mounting surface.

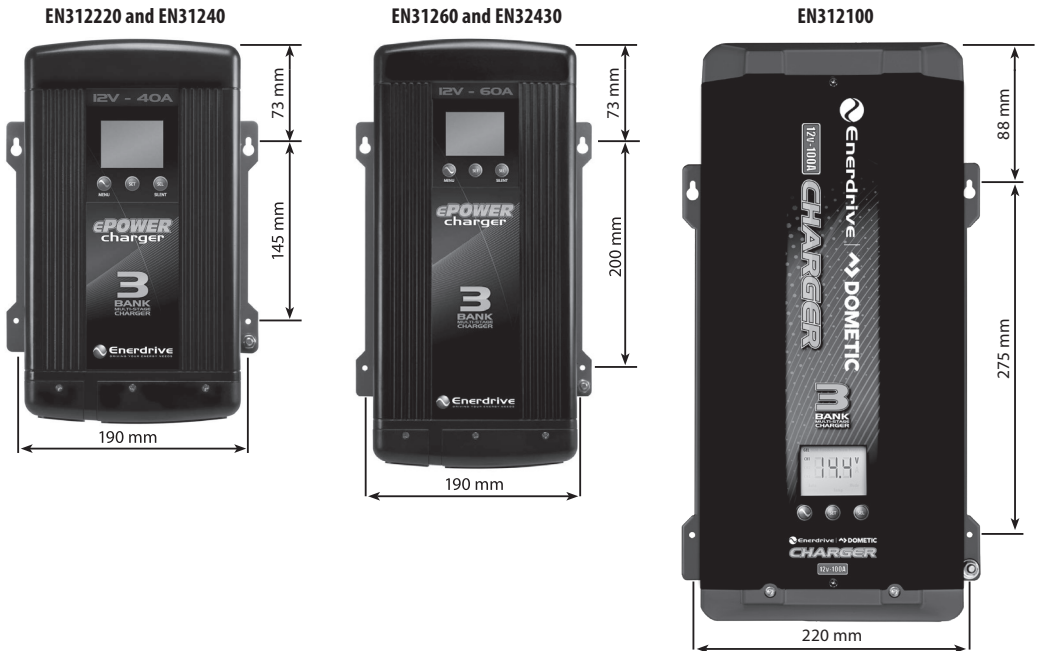

Chassis Grounding Connection

The unit is grounded through the ground stud located near the DC Output terminals, refer Section 3 on Page 10 and 11.

- For caravan, RV and other mobile applications the unit should be grounded with a minimum 4mm² conductor.
- For marine applications the unit shall be grounded to the main DC negative bus with a separate conductor the same capacity (size) as the DC positive conductor.

DC Output Wiring



WARNING: Correct DC Wiring is Required

The DC wiring used must be of appropriate size. An individual over-current protection device usually within 20cm of each battery bank is required. A DC disconnect switch is also recommended. Both devices must be rated for DC voltage and current and be rated to withstand the short circuit current available from the connected battery bank. Both devices must match with the size of the DC wiring.

Recommended Cable Length, Size And Required Fuse Size

Wire Length	Wire Size (mm ²) - Fuse Size (A)				
	EN31220	EN31240	EN31260	EN312100	EN32430
1.5 m	6mm ² – 30A	12mm ² – 50A	16mm ² – 80A	35mm ² – 120A	12mm ² – 40A
2.2m	6mm ² – 30A	16mm ² – 50A	25mm ² – 80A	50mm ² – 120A	16mm ² – 40A
6m (Not Recommended)	16mm ² – 30A	35mm ² – 50A	50mm ² – 80A	70mm ² – 120A	25mm ² – 40A

- Remove the DC compartment cover by removing the two screws located on the top surface of the unit near the AC wiring compartment.
- Keep the connection between the battery and the charger as short as possible.
- Connect one end of the positive wire (red wire) to the Bank one of charger positive terminal with torque 4.0 ~ 5.0 N-m and the other end to the over current protection device, then the DC disconnect device. Do not over tighten as this may result in damage to the charger.
- Connect another wire from the DC disconnect device to the battery bank.
- For systems with multi-battery banks: Follow the same instruction as on Bank 1 and connect to Bank 2 & 3 accordingly.
- Prepare the negative wire (black wire) and connect to the negative terminal of the charger.
- Connect the other end of the negative wire to the negative terminal of the battery bank(s) or the load side of a battery monitor shunt if installed.
- Place the DC Compartment cover back to the original position and secure the cover using the two screws provided.

Battery Temperature Sensor Connection

To install the temperature sensor, simply connect the RJ12 plug from the sensor to the RJ12 Temperature Sensor Port located near the Interface Port. On the temperature sensor end, simply connect the ring terminals to the negative terminal of the main battery bank.

Optional Remote Display Connection

- To install the optional Remote Display in a specific location, a 6 pin standard RJ12 cable (length of 7.5 meters supplied with Remote) is required.
- Install the standard RJ12 cable in your desired location.
- Connect one end of the RJ12 cable to the Interface Port and the other end of the cable to the Display Panel.
- The Remote Display is now ready for use.

Running The Battery Charger With Portable Generators

This charger is suitable for use with most sine wave inverter type generators only. Ensure your generator never runs out of fuel when running the battery charger. When a generator runs out of fuel, its final splutters of life produce very transient AC voltages that can damage your battery charger.

Be sure to purchase a good generator that has a clean AC output. If in doubt simply connect a surge protector (like you would use for your computer) to the generator.

The Enerdrive Battery Charger will run very comfortably from many of the common market generators around the 1kVA range for 20 and 40Amp charger models and 2kVA for 60 and 100 Amp charger models.

Note: Units can be programmed to a lower output if you need to run off a smaller kVA generator.

When you first start up your portable generator, let the generator reach a suitable operating temperature and stability before you plug in your battery charger.



NOTE

Using low cost, unregulated generators will likely result in charger damage not covered under the Enerdrive warranty.

Battery Wiring: Connecting The Batteries The Right Way

EN31220, EN31240, EN31260, EN32430 (Picture shows 12V setup - 24V would connect the same way but with 24V banks).

Positive
Negative

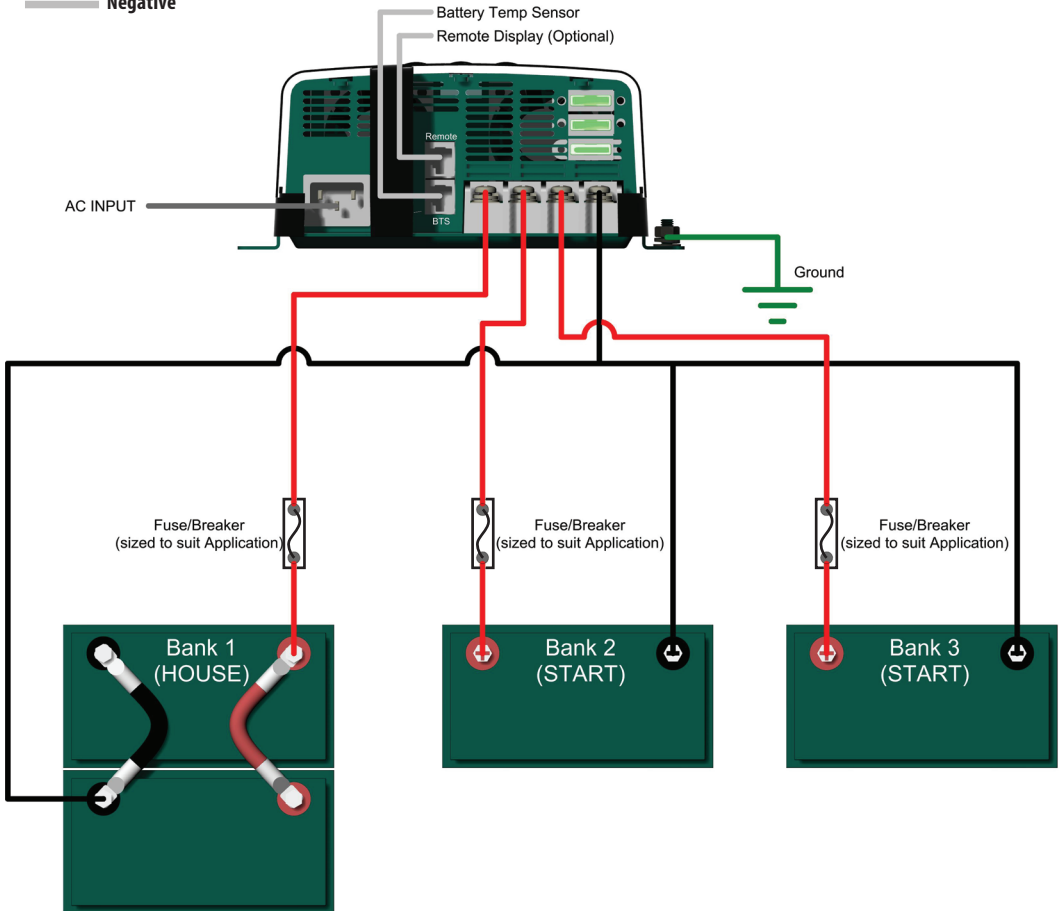

IMPORTANT NOTE

For Single Bank Charging: DO NOT Connect Bank 2 And 3 Outlet.

Battery Wiring: Connecting The Batteries The Right Way

EN312100

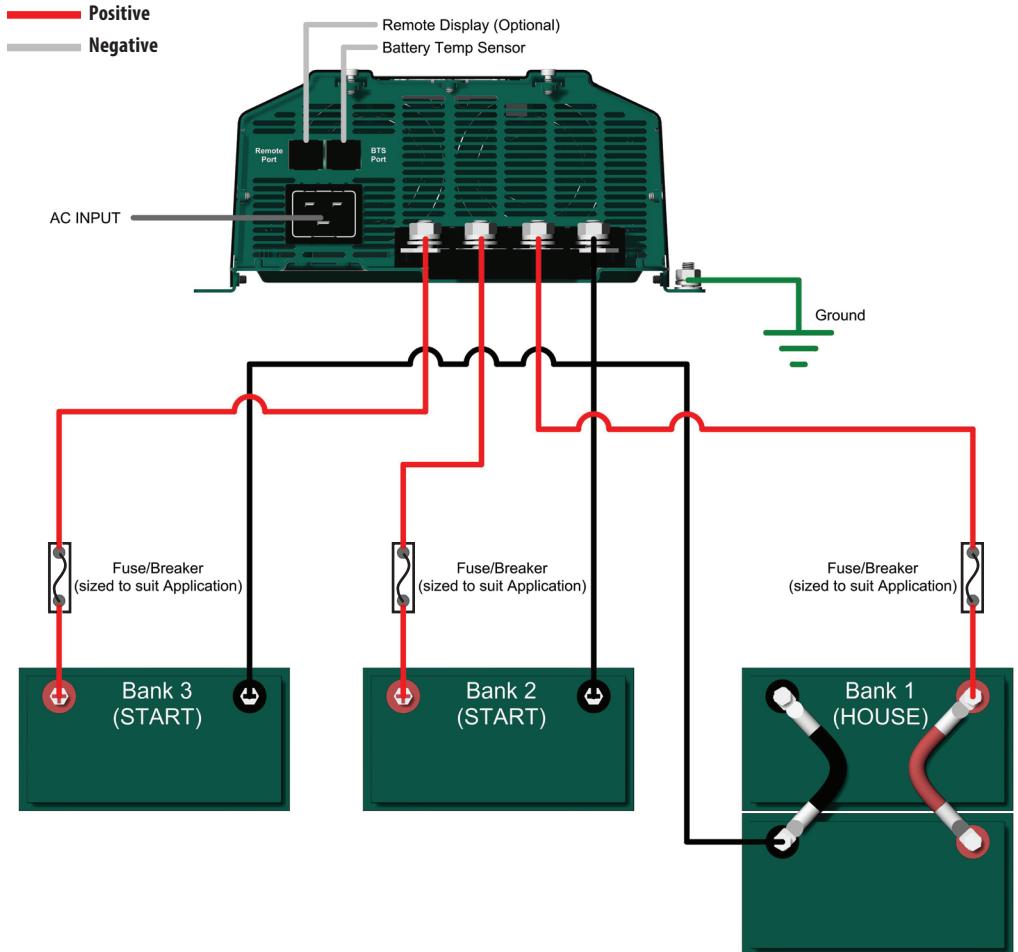

IMPORTANT NOTE

For Single Bank Charging: DO NOT Connect Bank 2 And 3 Outlet.

5. UNIT OPERATION

Understanding The Charging Mechanism

- The battery charger is a three bank battery charger that is capable of charging a maximum of three battery banks.
- The charger is designed to have Bank 1 charge the main battery bank. Always use Bank 1 first when connected to a single battery bank.
- At the start, if the charger senses Bank 2 and 3 has battery voltage above 12V, the charger will then concentrate on fully charging Bank 1 first or until it reaches float stage. It will then switch to charge Bank 2 and 3.

OR

- At start, if the charger senses either Bank 2 or Bank 3 have voltage below 12V, it will cycle to charge Bank 1 for 15 minutes then Bank 2 and 3 together for 15 minutes. When the charger senses both Bank 2 and 3 reached 13V, it will then concentrate on charging Bank 1 until it reaches the float stage. After, it will then concentrate on recharging Bank 2 and 3 to float stage.
- Once all three banks have reached the float stage, the charger will adjust the charger voltage to the preset float voltage and all three banks will be connected in parallel with a diode for bank separation.

In float stage, see the below chart for the maximum allowable current draw:

Model	EN31220	EN31240	EN31260	EN312100	EN32430
Maximum Float Current	20A	40A	40A	60A	30A

For Charging GEL, AGM And Flooded Batteries

The charger can be set to Mode 2 - 2 stage charging (Bulk and Absorption stage charging only) or Mode 3 – a 3 stage charging (Bulk, Absorption and Float stage charging).

Bank 1 can be set separately to Bank 2 & 3.

For Charging Lithium LiFeP04 Batteries

This can only be set at Bank^①, it has its own charging voltage and current setting. It also requires the user to set the charger termination current. The charging process will terminate when the charging current drops to the set termination current. Bulk re-start occurs when battery voltage drops below 13.3V DC.

^①EN312100 can be programmed for Lithium on 2 & 3.

For Using Charger As Power Supply (Program Setting)



NOTE

With this setting, only Bank 1 can be used and the other banks are disabled.

The charger can be used as a constant voltage power supply that will deliver the preset output voltage (13.3, 13.5, 13.7 V) with the maximum current setting. With this setting, only Bank 1 can be used and the other banks are disabled (double this number for 24V).

Understanding The Display And Function Keys During Normal Operation

During normal operation, the display shows the related channel's battery voltage, charging current and charging stage ('bUL' – Bulk stage, 'Ab5' – Absorption stage, 'Flo' – Float stage) alternatively. When the 'MENU' key is pressed, it displays the other channel's battery voltage only.

When all channels reach float stage, the display will show 'Ful' indicating all the batteries connected are fully charged and presently in float mode.

Understanding The Function Key 'MENU', 'SET' And 'SEL' During Charger Setting

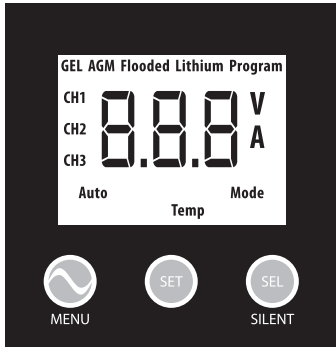

With the AC connected and turned ON:

MENU: Press and hold the key for longer than 3 seconds to enter charger setting mode and show function setting.

Once new setting is done, press 'MENU' again for longer than 3 seconds to exit the charger setting mode.

SET: Press the key once to keep / save the chosen setting and change the display to show the next menu to continue other settings.

Note: *The selected setting will quickly flash 3 times to acknowledge the setting.*

SEL: Press the key to view other available settings.

Understanding The Three-Stage (Mode 3) Charging

The Three-Stage Charging (Mode 3) has a Bulk, then Absorption and then Float sequence. During the Bulk stage, the battery accepts the maximum constant current from the charger. In the Absorption stage, the battery voltage is held to constant voltage and the charging current will slowly reduce. In Float stage, the charger continuously produces lower constant float voltage to fully top up and maintain the battery in a fully charged state.

The charger will automatically restart the full charging cycle if it senses anyone of the battery bank is discharged to lower than 12.8V (13.3V for Lithium) or after seven days in float stage to refresh the battery banks.

Understanding The Two-Stage (Mode 2) Charging

The Two-Stage charging is similar to the Three-Stage charging except there is no float stage after the absorption stage. The charger will terminate the battery charging after Absorption.

The charger will automatically restart the full charging cycle if it senses anyone of the battery bank is discharged to lower than 12.8V (13.3V for Lithium) or after seven days in float stage to refresh the battery banks.

Understanding The Battery Temperature Functions

The Battery Temperature Sensor is included with the charger to protect your battery and provide better charging voltage accuracy.

When the battery temperature sensor is used, it is highly recommended to be installed on the main battery bank at the negative terminal - Bank one.

The sensor senses the battery temperature and overrides the manual temperature settings and makes small adjustments to the charging voltage.

Battery Temperature	Battery Charging Voltage Adjustment from 25 °C normal setting	
	Flooded and GEL type	AGM type
< 25 °C	+ 0.027 V /°C	+ 0.021 V /°C
25 °C	0 V	0 V
> 25 °C	- 0.027 V /°C	- 0.021 V /°C

Note: The above voltage compensation will only work with the supplied Battery Temperature Sensor fitted which will override the unit temperatures' (Lo, Nor, Hi) setting. When Lithium profile is selected battery temperature is only used for High and Low temperature shutdown. Refer to battery manufacturer's manual if temperature sensor is required.

When the battery sensor is not in use, you can also manually set the battery temperature. There are three manual battery temperature settings on the unit ('Lo', 'nor' and 'hi').

Temperature Setting	Recommended for Battery Temperature	Battery Type	Voltage adjustment from 25°C normal setting
Low (Lo)	<5°C	GEL, Flooded	0.675 V
		AGM	0.525 V
Normal (nor)	>5°C and <30°C	GEL, Flooded	0 V
		AGM	0 V
High (HI)	>30°C	GEL, Flooded	-0.27 V
		AGM	-0.21 V

Procedure To Set Or View Charger Setting

Follow the procedure or sequence in Appendix A1 and A2 (see pages 38 to 41 of this manual) to set or view the charger setting.

GEL, AGM Or Flooded Battery Type:

Parameters below are required for setting:

- Battery type (GEL, AGM, Flooded)
- Maximum Current setting (see table below)
- Absorption to float mode current setting (see table below)
- Charging stage (3-stage , 2-stage)
- Battery temperature (low, normal, high temperature) or connect the temp sensor to over-ride

The following table shows the maximum available charging current and its related available Absorption to Float Mode current.

Model	Charging Voltage	Maximum Charging Current	Termination Charging Current
EN31220	14.2V / 14.3V / 14.4V	* 20A	2A / *4A / 6A
		15A	1.5A / 3A / 5A
		10A	1A / 2A / 3A
		5A	0.5A / 1A / 1.5A
EN31240	14.2V / 14.3V / 14.4V	* 40A	* 4A / 6A / 8A
		20A	2A / 4A / 6A
		10A	1A / 2A / 3A
		5A	0.5A / 1A / 1.5A
EN31260	14.2V / 14.3V / 14.4V	* 60A	* 6A / 9A / 12A
		40A	4A / 6A / 8A
		20A	2A / 4A / 6A
		5A	0.5A / 1A / 1.5A
EN312100	14.2V / 14.3V / 14.4V	*100A	* 3A / 4.5A / 6A
		80A	2A / 4A / 6A
		60A	* 6A / 9A / 12A
		40A	0.5A / 1A / 1.5A
EN32430	28.4V / 28.6V / 28.8V	* 30A	* 3A / 4.5A / 6A
		20A	2A / 4A / 6A
		10A	1A / 2A / 3A
		5A	4A / 6A / 8A

Note: * Recommended setting (Factory Default Setting)

Lithium LiFeP04 Battery Type

Parameters below are required for setting:

- Charging Voltage (13.9V, 14.0V, 14.1V, 14.2V, 14.3V, 14.4V, 14.5V 14.6V)
- Maximum Charging Current (see table below)
- Termination Charging Current (current to define when the charging process will terminate)

The following table shows the available charging voltage, maximum charging current, and the available termination charging current.

Model	Charging Voltage	Maximum Charging Current	Termination Charging Current
EN31220	14.2V / 14.3V / 14.4V	* 20A	2A / *4A / 6A
		15A	1.5A / 3A / 5A
		10A	1A / 2A / 3A
		5A	0.5A / 1A / 1.5A
EN31240	14.2V / 14.3V / 14.4V	* 40A	* 4A / 6A / 8A
		20A	2A / 4A / 6A
		10A	1A / 2A / 3A
		5A	0.5A / 1A / 1.5A
EN31260	14.2V / 14.3V / 14.4V	* 60A	* 6A / 9A / 12A
		40A	4A / 6A / 8A
		20A	2A / 4A / 6A
		5A	0.5A / 1A / 1.5A
EN312100	13.9V - 14.6V	* 100A	4A / 8A / 12A
		80A	2A / 4A / 6A
		60A	3A / 6A / 12A
		40A	2A / 4A / 8A
EN32430	28.4V / 28.6V / 28.8V	* 30A	* 3A / 4.5A / 6A
		20A	2A / 4A / 6A
		10A	1A / 2A / 3A
		5A	0.5A / 1A / 1.5A

Program (Power Supply) Type

Parameters below are required for setting:

- Supply Voltage 13.3, 13.5, 13.7 Vdc
- Maximum available current (see table)

The following table shows the programmable voltage and the maximum current setting.

Model	Program Output Voltage Setting	Max. Current
EN31220	13.3V/13.5V/13.7V	20A/15A/10A/5A
EN31240	13.3V/13.5V/13.7V	40A/20A/10A/5A
EN31260	13.3V/13.5V/13.7V	60A/40A/20A/5A
EN312100	13.3V/13.5V/13.7V	100A/80A/60A/40A
EN32430	26.6V/27.0V/27.4V	30A/20A/10A/5A

Procedure To Equalise Flooded Battery



DANGER Explosion hazard and risk of battery damage

The battery generates explosive gases during equalisation. Follow all the battery safety precautions listed in the manual. When using the equalisation mode, the user has to be sure the battery connected to the channel is a flooded battery type. Equalising a non-flooded battery may overcharge the battery and may cause the battery to explode.



CAUTION

RISK OF BATTERY AND EQUIPMENT DAMAGE.

Only the Flooded lead-acid can be equalised. Consult your battery manufacturer or read the battery manual when you try to equalise your batteries.

Disconnect any DC load connected to the battery, as during equalise mode, the charger will produce 15.5V to the batteries. You must monitor the battery specific gravity throughout the equalisation process to determine the end of the equalising schedule.

Before setting the equalisation mode on the specific channel, please be sure the channel chosen for battery equalisation is for a flooded battery type. When the battery equalisation is for a flooded battery type. When the battery equalisation is started, the charger will automatically fully charge the selected channel first and follow with 1 hour of equalisation. Check the battery electrolyte level during the equalisation period. If necessary, refill with distilled water only. All cells should have similar electrolyte levels. If distilled water is added, batteries must undergo a complete charge cycle. The charger cannot determine when to terminate the equalisation of the battery. A one hour time-out is set and this is used as a safety feature to require the user to continually re-activate it as necessary after checkin batteries manually.

During equalisation mode the other two banks are disabled.

Use the following procedure to setup the charger for battery equalisation.

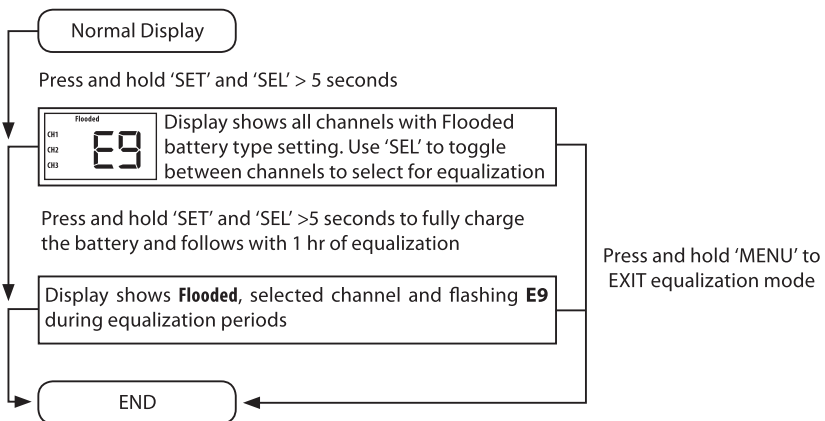

Understanding The Silent Mode Function



SILENT

The charger also comes with a unique function called Silent Mode, which will stop the internal fan from operating. **TIP:** Use this function during night time or when a quiet environment is needed. Please also note that the charging time will increase in this mode because the charger is not running at maximum power. This function can switch to ON or OFF at any time during the charging period. function can switch to ON or OFF at any time during the charging period. To set this function, press and hold 'SEL' key for 3 seconds to execute the 'Silent' mode. The unit is in silent mode when the word AUTO appears on the display.

To turn this function off, press and hold the 'SEL' function for 3 seconds to exit the 'Silent' mode. The 'Silent' icon on the display will turn off and the charger current and the fan speed will return to normal. The charger will automatically depart 'Silent' Mode after 12 hours from initial depress.

Understanding The Protection Features

De-rating Charging Current:

When the charger senses the environmental temperature is above 50°C, the maximum charger current will de-rate to 1/2 of the value (A02 warning code will display). The charger will recover automatically back to maximum charging current when the environmental temperature drops to below 45°C.

Over Temperature Shutdown:

When the charger senses the environmental temperature is above 60°C, the charger will shutdown. It will recover automatically when the environmental temperature drops to below 45°C.

Battery Reverse Polarity:

When a reverse polarity is connected to the battery bank, Fault Code E03 on display will appear. In some cases, the user replaceable DC fuse located near the DC Output terminals may blow and Error code E08 will display.

AC Input Voltage Protection:

The charger will shutdown when it senses the AC input voltage is outside of the operating range. A fault code will display 'E02'. The charger will recover automatically when it senses the AC input voltage has returned back to the normal operation range.

Charging A Dead Battery

The charger is designed to charge batteries with terminal voltage greater than 2.5Vdc.

If the battery voltage is lower than 2.5VDC then the charger must be switched to PROGRAM (Power Supply) mode in order to charge. It is recommended to set the charge current to the lowest setting to help prevent any possible overheating of the battery during charging.

Recharging a dead flat battery requires extreme care and attention. It is recommended to recharge using short frequent cycles rather than one long bulk cycle. Battery damage or failure may occur if the battery is discharged deeply.

Understanding The Error Codes

Error codes will show on the display when either an internal fault such as high internal temperature or external fault like AC input voltage out of range is detected. The unit will shutdown.

Code	Condition	Corrective Action
A01	Temperature Sensor (BTS) is defective.	Check and or replace the sensor.
E01	Unit shutdown due to low AC Input (< 85 +/- 5Vac)	Check AC input source. The unit will automatically recover when the AC Input voltage return to > 108 +/-5Vac
E02	Unit shutdown due to high AC Input (>270 +/- 5Vac)	Check AC input source. The unit will automatically recover when the AC Input voltage return to < 260 +/-5Vac
E03	Battery is connected backwards	Check all battery connections
E04	Charger Internal temperature is too high and unit has shutdown. Unit will automatically recover when the unit cools down.	The ventilation of the unit is blocked or the environmental temperature is high. Reduce charging current or improve the ventilation near the unit.
E06	High battery temperature >70 °C (>60°C for Lithium is sensed by the BTS. The unit will shutdown. Unit will automatically recover when battery temperature has reduced to 60°C (55°C for Lithium).	Check battery, charger setting and the environment the charger is in.
E07	Low battery temperature < -25°C (<0°C for Lithium is sensed by the BTS. The unit will shutdown. Unit will automatically recover when battery temperature reaches -20°C (>5°C for Lithium).	It is not recommended to charge the battery at extreme low temperatures.
E08	DC Output fuses are blown.	Check battery connection and replace fuse with the same type and rating.
E09	Unit shutdown due to high battery voltage (> 17Vdc). Unit will automatically recover when voltage has reduced to 16Vdc.	Check battery and charger setting. Check also if there is any other DC supply connected to the battery banks.

6. SPECIFICATIONS

Model	EN31220	EN31240	EN31260	EN312100	EN32430
Charger Output:					
Output Current (Maximum)	20A	40A	60A	100A	30A
Output Voltage Range:					
Charge	14.2 - 15.5 V				28.4 - 31.0 Vdc
Float	13.4 - 13.8 V				26.8 - 27.6 Vdc
Equalise	15.5 Vdc				31.0 Vdc
Charging Control	Three stages (Bulk/Absorption/Float)				
	Two stages (Bulk/Absorption)				
	Constant Power Supply (Program setting)				
DC Output Bank	Three (1 fully independent, 2 common with diode isolation)				
Selectable Battery Type	Gel, AGM, Flooded, Lithium, Program (Flooded default)				
Standby Current	< 2 mA		< 5 mA		< 1 mA
Charger Input:					
AC Input Voltage (Nominal)	100, 120, 220, 230, 240 VAC				
AC Input Operating Range	90 - 265 VAC				
AC Input Frequency Range	47 - 63 Hz				
Power Consumption	350W Max	700W Max	1050W Max	1750W Max	1050W Max
Power Factor Correction	Yes				
Charger Efficiency	> 82%				
Protection and Features:					
Reverse Battery	Yes, unit shutdown				
Over Charge	Yes, unit shutdown				
Over Temperature	Yes, unit de-rated and shutdown				
Output Short Circuit	Yes, unit shutdown				
DC Fuse	2*15A, 32V	2*30A,32V	3*30A,32V	N/A	3*20A, 32V

Model	EN31220	EN31240	EN31260	EN312100	EN32430
Cooling	Forced air ventilation				
Temperature Setting	Low, Normal, High (no sensor connected)				
Battery Temperature Sensor Port	RJ12 (standard battery temperature sensor supplied)				
Digital Display Port	RJ12 (optional display panel available)				
Display:					
LCD Display	Backlit display. Charging status, Battery Voltage and Output Current				
Warning and Fault Code	Shown on display				
AC Input and DC Output Connection:					
AC Input Connection	IEC with Supplied 1.2M Power Lead				
DC Output Connection	6mm Screws		8mm Studs		6mm Screws
DC Output Ground	Single Heavy Duty Common Ground Stud. 6mm ring terminals.				
Environmental and Operating Temperature:					
Storage Range	-40° to 70° C				
Operating Range	-20° to 60° C				
Humidity	5-95%, RH non-condensing				
Ingress Protection	IP32 - Protected against solid objects over 2.5mm and water sprays up to 15° from vertical.				
Base Unit Weight and Dimensions:					
EN31220	2.4 Kg / 295 x 206 x 86 mm				
EN31240	2.6 Kg / 295 x 206 x 86 mm				
EN31260 / EN32430	4.0 Kg / 356 x 206 x 99mm				
EN312100	6.4 Kg / 425 x 236 x 102.7mm				
Optional Accessories:	Remote Digital Display / Enerdrive Part Number EN3REM				
Regulatory Compliance:	Complies with AS/NZS 60335.2.29 Including Australian deviations.				

Note: Specifications are subject to change without notices.



7. WARRANTY



5 Year Warranty

In the unlikely event that a technical issue arises with an Enerdrive product, customers are encouraged to initially contact the Enerdrive Support Team on 1300 851 535 or: support@enerdrive.com.au for immediate and efficient expertise and first class product support.

Important Note: Consumer Protections

If you have purchased your product in Australia, you should be aware that:

This warranty is provided in addition to other rights and remedies held by a consumer at law. Our goods come with guarantees that cannot be excluded under the Australian Consumer Law. You are entitled to a replacement or refund for a major failure and for compensation for any other reasonably foreseeable loss or damage. You are also entitled to have the goods repaired or replaced if the goods fail to be of acceptable quality and the failure does not amount to a major failure.

Enerdrive warrants that its Products will be free from defects in materials and workmanship (subject to limits and in normal conditions, as described in the complete Enerdrive Warranty Policy) for up to 5 years from the date of purchase.

For full terms, conditions and claim process, refer to the Enerdrive website.

<https://enerdrive.com.au/warranty/>

Charger configuration is a simple step by step process as shown below.
 For Tech Support call Enerdrive on **1300 851 535**
NOTE: The current setting below is based on the EN31240 battery charger.

Appendix A1

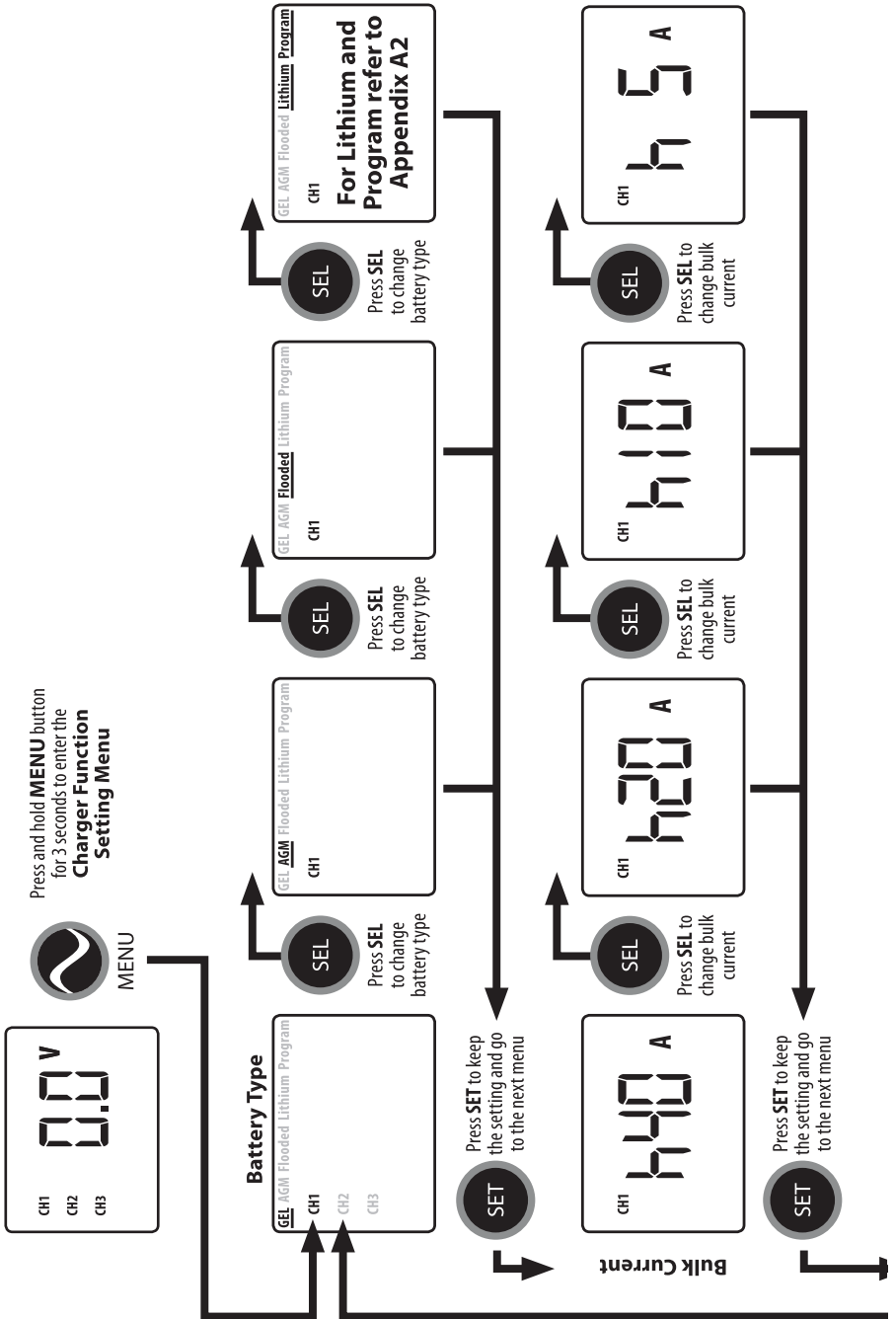

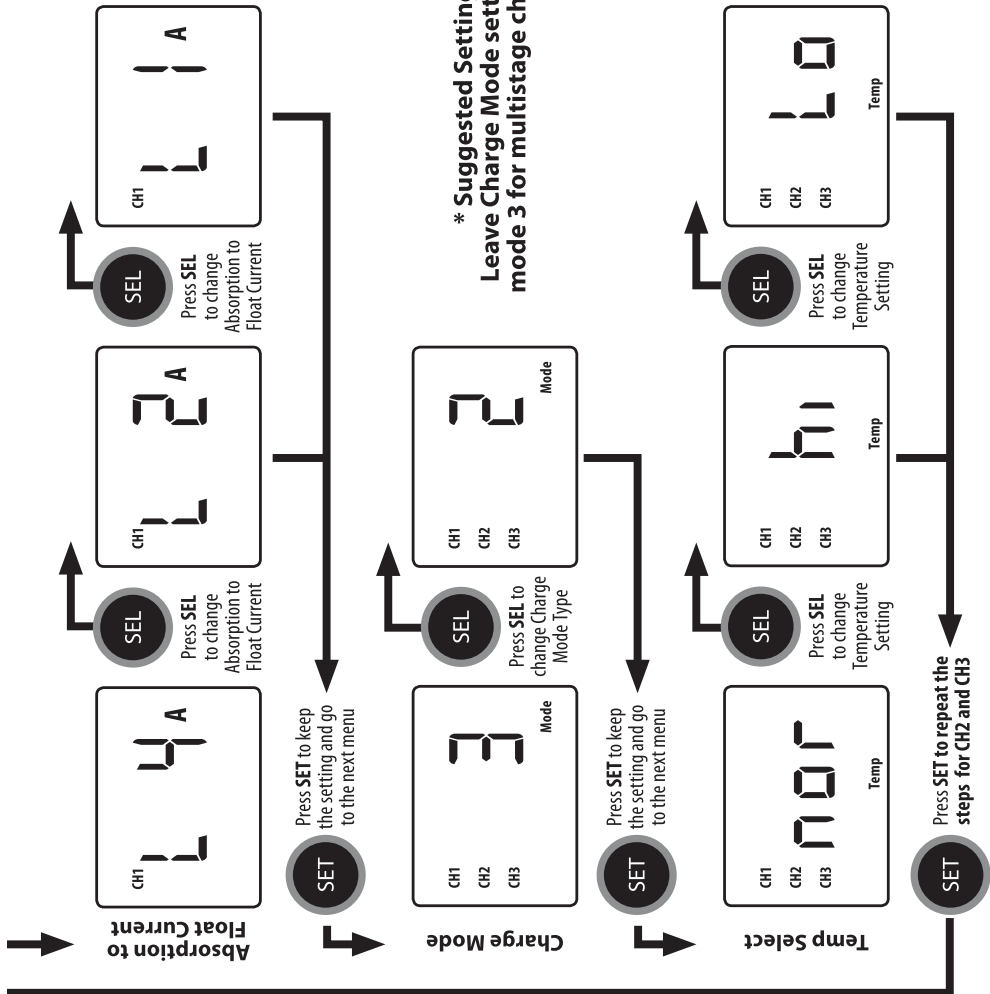

*** Suggested Setting.**
 Leave Charge Mode setting on mode 3 for multistage charging.

*** Disregard the Temp Select setting if the Temperature Sensor is connected.**

Appendix A2:

Lithium Profile and Custom Set Points

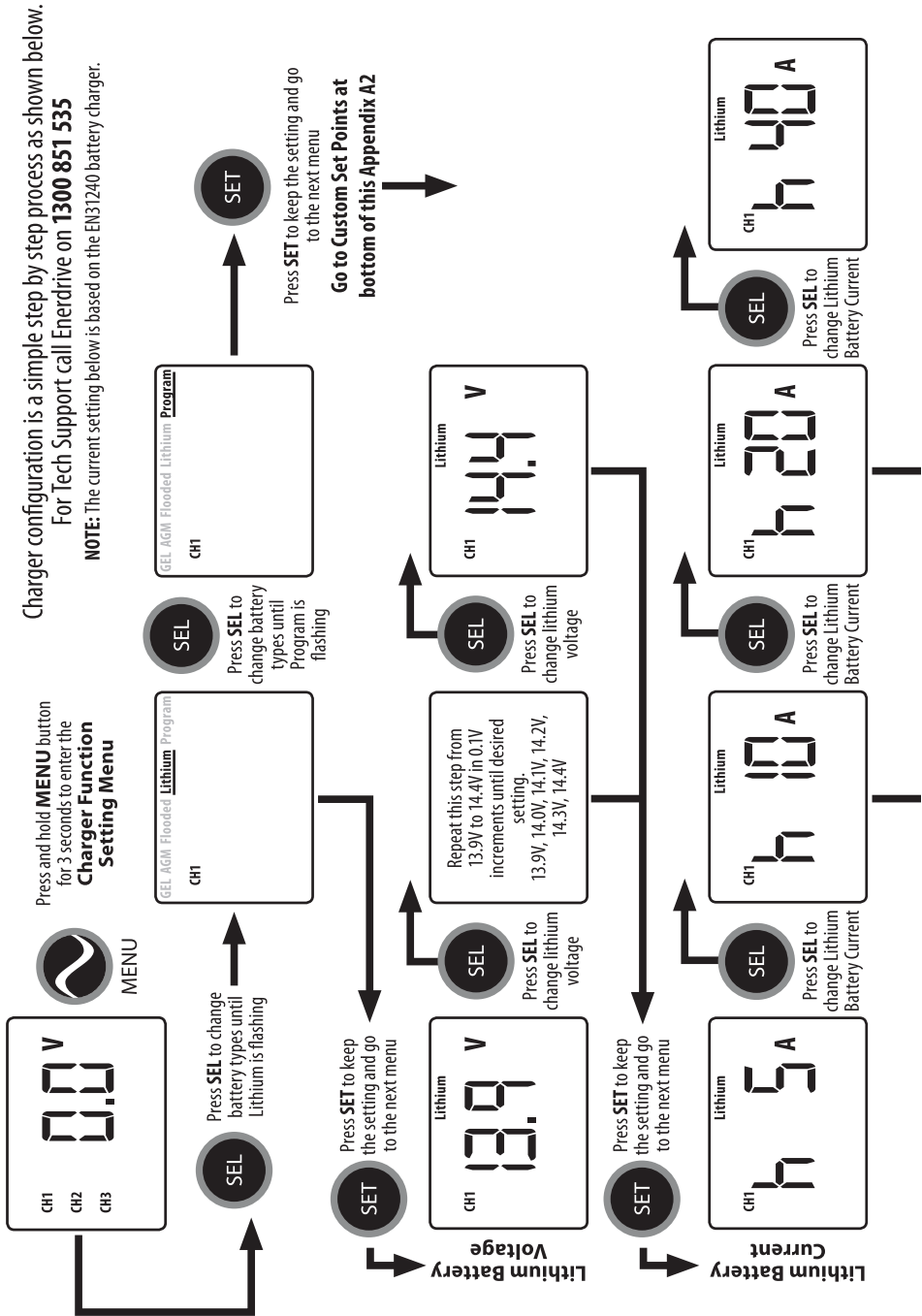

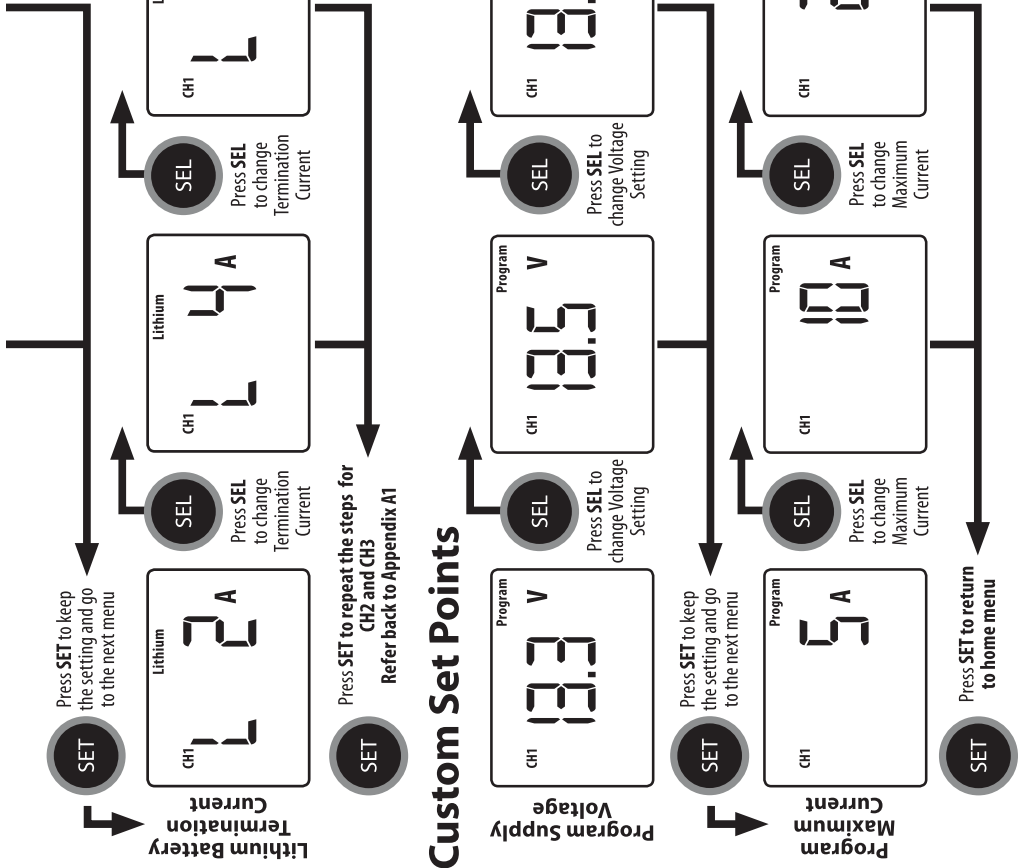



ENERDRIVE

DOMETIC

Dometic Power & Control (Enerdrive) Pty Ltd

P.O. Box 9159, Wynnum Plaza, Queensland, Australia 4178

Ph: 1300 851 535 / Fax: 07 3390 6911

Email: support@enerdrive.com.au

Web: www.enerdrive.com.au