

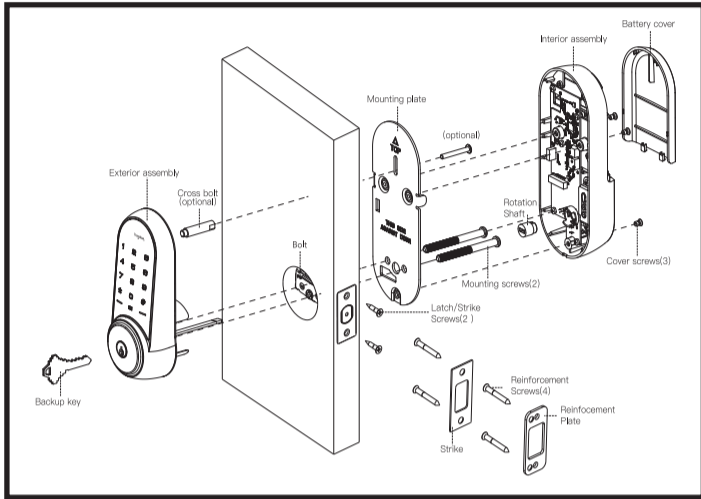

HU03 Installation Guide

Installation Guide



Additional Parts	Tool Needed	Lock Installation #2 Philips screwdriver
Optional Bolt Faceplate	Door prep 1. 2-1/8" (54mm) hole saw 2. 1" (26mm) boring bit 3. 7/64" (2.5mm) drill bit 4. 3/8" (10mm) drill bit 5. Chisel&Hammer	Important Notice: Make sure your door is prepared prior to installation. Only drill a upper hole if you wish the lock to have added stability. Please refer to the provided templatior drilling if needed.

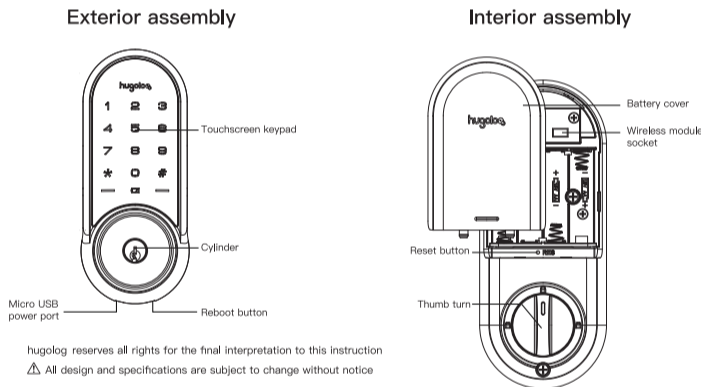

Preparing for Installation

A. Measure the dimension of the hole shown. If the measurement is 1-1/2"(38mm), remove the fire cup.

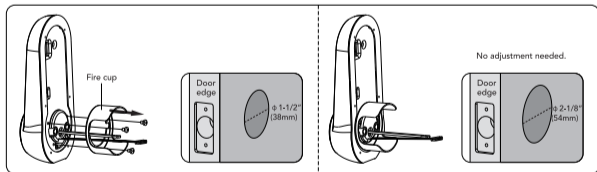

B. Change faceplate, if necessary.

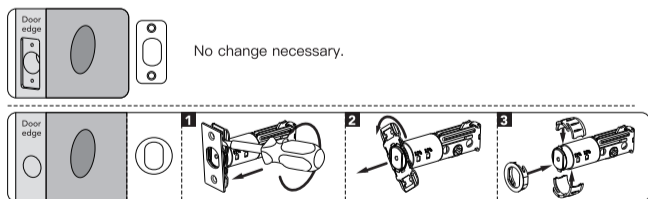

C. Adjust the deadbolt.

NOTE: Bolt ships with backset in 2-3/8"(60mm) position. If required, turn the bolt case end and pull to extend to 2-3/4" (70 mm) backset position. (see picture below)

The bolt must be in retracted (unlocked) position when you are changing backset.

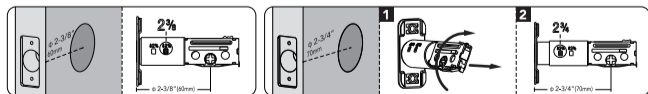

D. Adjust the tailpiece according to your door's thickness.

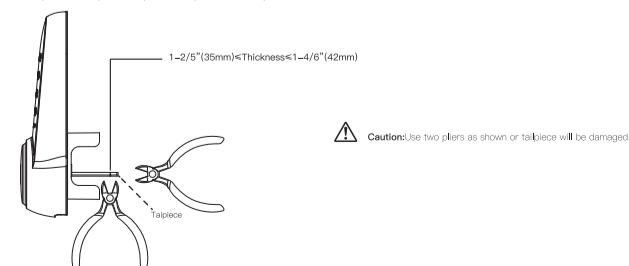

Installation

1. Install strike on the door frame.

NOTE: Make sure to allow for the bolt to be centered in the strike.

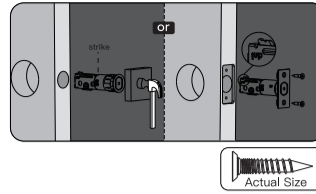

2. Use a screwdriver to test if deadbolt works smoothly.

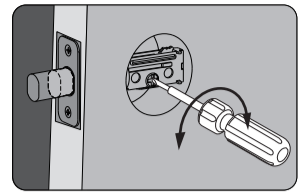

3. Make sure the bolt is in retracted (unlocked) position.

NOTE: The bolt must be in retracted (unlocked) position before installing the lockset.

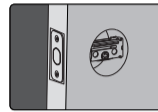

4. Hold the exterior assembly flush to the door, pull the key tailpiece and cable through the door hole.

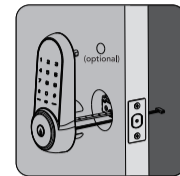

This hole is for the optional cross bolt provided for stabilizing your lock. If you drilled a hole, securely tighten the post before mounting on your door.

NOTE: Cable must go through door hole under the bolt.

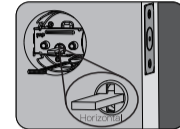

NOTE: The tailpiece should be kept in a horizontal position.

5. Position the inside mounting plate by first routing the cable and connector plate through the mounting plate's cable hole.

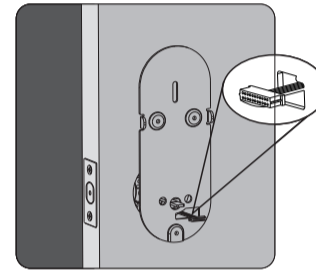

6. Secure both assemblies using 8/32x3/4 (optional) and 1/4x65 screws. Make sure that exterior assembly is vertically aligned. Tighten securely with a #2 Philips screwdriver.

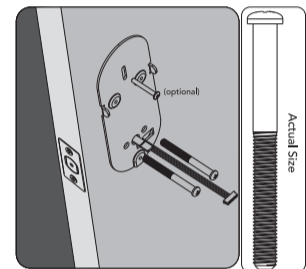

7. Place rotation shaft in the hole on the inside assembly.

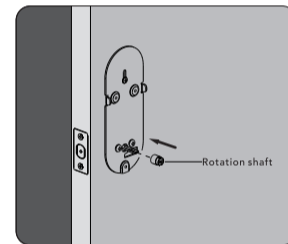

8. Attach cable assembly to the interior assembly PCB by lining up notches on top of cable connector to slots on PCB connector. Press connector in firmly using thumbs until completely connected.

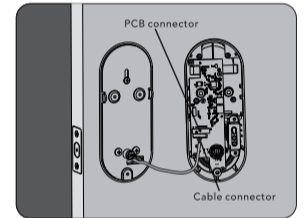

9. Install interior assembly on inside mounting plate.

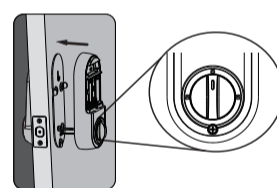

10. Secure using screw through the interior assembly onto the mounting plate.

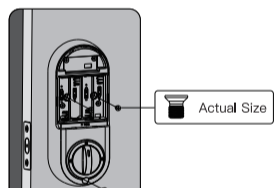

NOTE: The horizontal orientation of the tailpiece as you insert the inside escutcheon (thumb turn should be vertical).

NOTE: Testing operation using backup key and thumb turn before installing batteries, see if both works smoothly.

11. Reset the lock to learn the orientation of your door.

NOTE: Resetting the lock before use is required and crucial for the lock to operate properly.

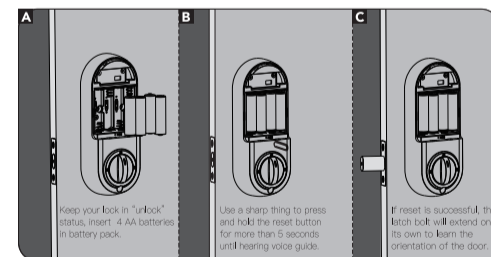

12. Install battery cover.

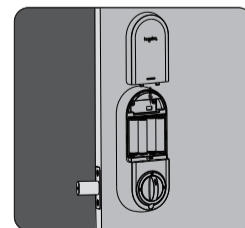

13. Install reinforcement plate and strike into door jamb.

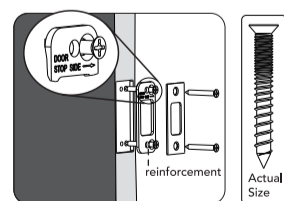

Download APP

Bluetooth network configuration must be restored to factory settings first, and network configuration completed within 5 minutes after factory reset.



HU03
Guía de Instalación

Guía de Instalación

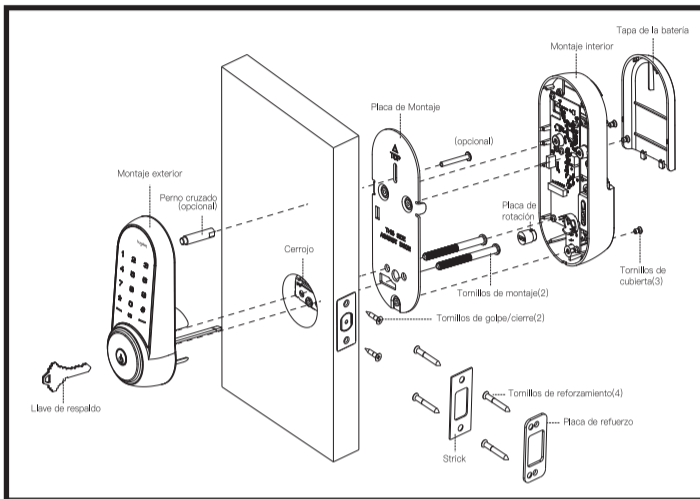

Partes adicional	Herramientas necesarias	Guía de instalación de cerraduras Destornillador Phillips n.º 2
Placa frontal de perno opcional	Preparación de la puerta 1. Sierra de orificio de 2-1 / 8 "(54 mm) 2. Broca aburrida de 1 "(26 mm) 3. Broca de 7/64 "(2.5 mm) 4. Broca de taladro de 3/8 "(10 mm) 5. Cíncel y martillo	Noticia importante: Asegúrese de que su puerta esté preparada antes a la instalación. Solo taladre un agujero superior si desea que la cerradura tenga mayor estabilidad. Consulte la plantilla provista, para perforar si es necesario.

Montaje exterior



Montaje interior

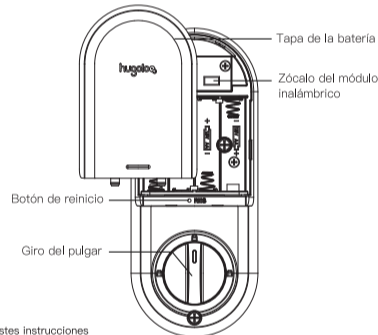

Preparando la Instalación

A. Mida la dimensión del orificio que se muestra. Si la medida es de 1-1 / 2 "(38 mm), retire la copa de fuego.

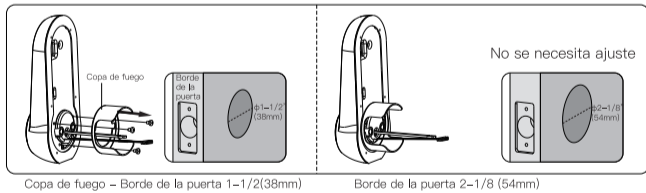

B. Cambie la placa frontal, si es necesario.



C. Ajuste el cerrojo

Nota: El tornillo se envía con el respaldo en una posición de 2-3 / 8 "(60 mm). Si es necesario, gire la caja del perno y tire para extenderla a una posición de retroceso de 2-3 / 4 "(70 mm). (ver fotos abajo)

⚠ El tornillo debe de estar en la posición retraído(desbloqueado) cuando este cambiando el basket.

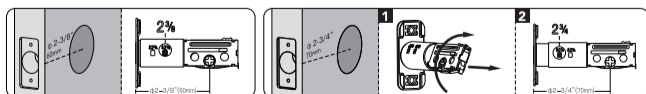

D. Ajuste el cordal de acuerdo con el grosor de su puerta.

Rompa con cuidado la cola del cilindro en la marca requerida para el grosor de su puerta

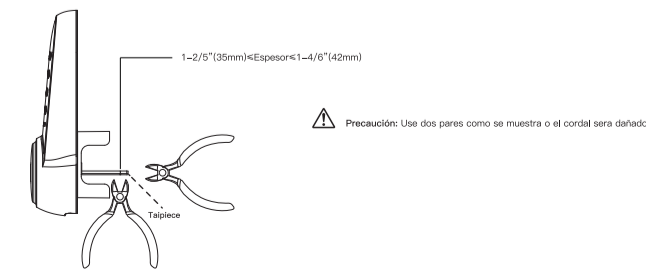

Installation

1. Instale la huelga en el marco de la puerta.
2. Use un destornillador para probar si el cerrojo funciona suavemente.

⚠ NOTA: Asegúrese de permitir que el perno se centre en la punta.

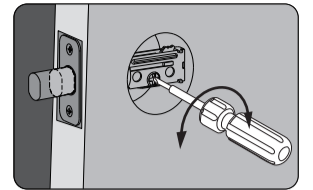
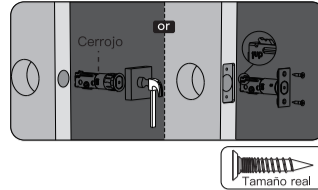

3. Asegúrese de que el pestillo esté retraído (desbloqueado) posición.
4. Mantenga el conjunto exterior al ras de la puerta, jale la pieza de la llave y el cable a través del Agujero de la puerta.

⚠ NOTA: El pestillo debe estar en posición retraída (desbloqueada) antes instalar el juego de cerraduras.

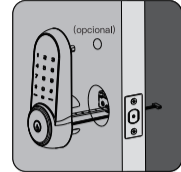
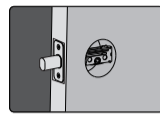

⚠ NOTA: Cable debe de ir por a través del agujero debajo de la puerta.

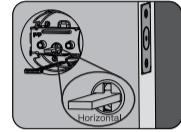
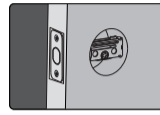

⚠ NOTA: El cordal debe ser mantenido en posición horizontal.

5. Coloque primero la placa de montaje interior enrutando el cable y el conector a través del orificio de cable de la placa de montaje.
6. Asegure ambos conjuntos usando 8 / 32x34 (opcional) y tornillos 1 / 4x65. Asegúrese de que el exterior El ensamblaje está alineado verticalmente. Apriete bien con un destornillador Phillips n.º 2.

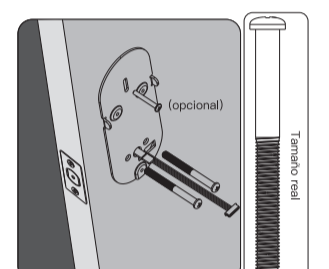
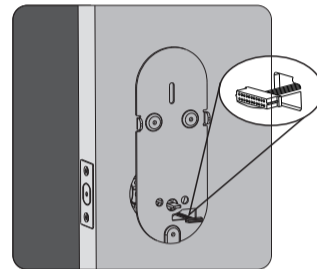

7. Coloque el eje de rotación en el orificio en el interior montaje.
8. Conecte el conjunto de cables al conjunto interior PCB alineando muescas en la parte superior del conector del cable a las ranuras en el conector de PCB. Presione el conector hacia adentro usando firmemente los pulgares hasta que estén completamente conectados.

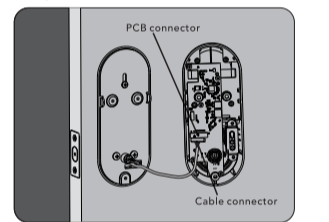
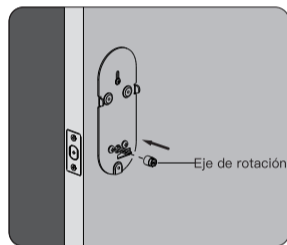

9. Instale el ensamblaje interior en el montaje interior plato.
10. Asegure con un tornillo a través del interior montaje en la placa de montaje.

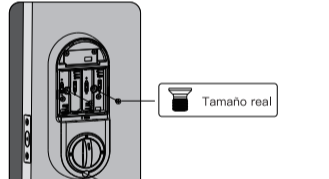
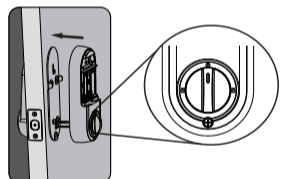

⚠ NOTA: La orientación horizontal de la tapicele a medida que inserta el Escudo interior (el giro del pulgar debe ser vertical)

⚠ NOTA: Prueba de operación con la tecla de respaldo y el giro del pulgar antes instalando baterías, vea si el perno funciona sin problemas.

11. Restablezca la cerradura para conocer la orientación de su puerta.

⚠ NOTA: Restablecer el bloqueo antes de su uso es necesario y crucial para que el bloqueo.

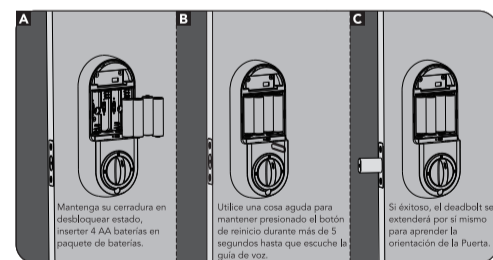

12. Instale la tapa de la batería.
13. Instale la placa de refuerzo y golpee en marco de la puerta.

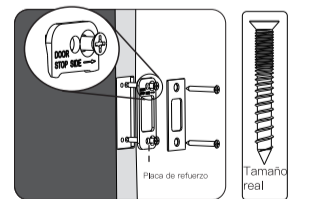
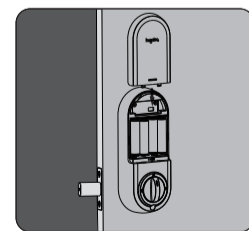

Descargar APP

Debe de restaurar primero la configuración de la red Bluetooth a configuración de fábrica, y completar la configuración dentro de 5 minutos de haber restaurado a configuración de fábrica.