

# LEISURE 470

## USER MANUAL

Please read this manual thoroughly before using this product and keep it for future reference.

# PACKING LIST

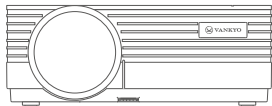

LEISURE 470



Remote  
(Batteries Not Included)



User Manual



AV Cable

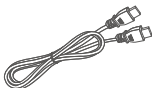

HD Cable

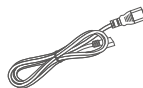

Power Cable

## NOTICE

### Recommended

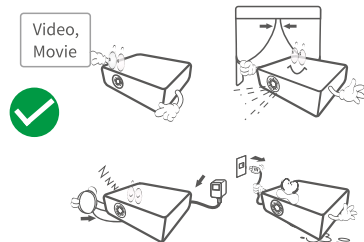

### NOT Recommended

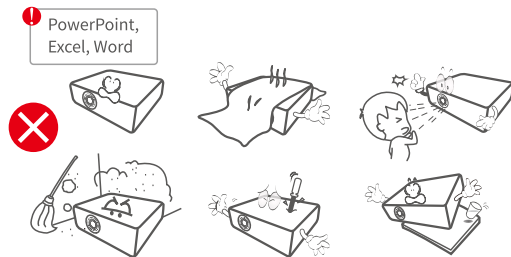

# FUNCTION OVERVIEW

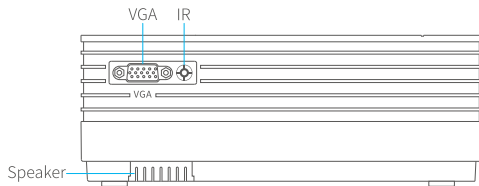
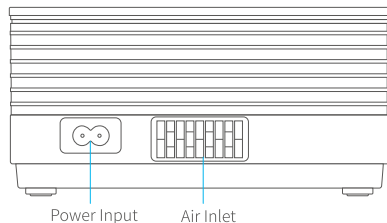
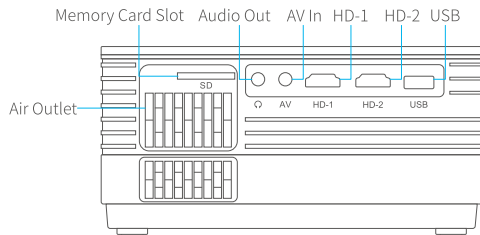
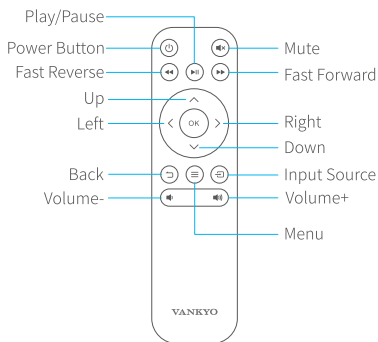
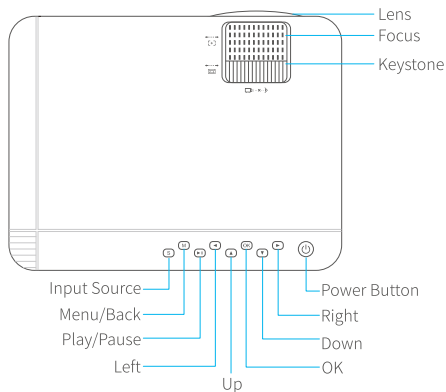

## QUICK START

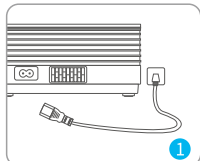

Plug the power cord into an outlet.

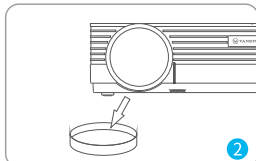

Take off the lens cover.

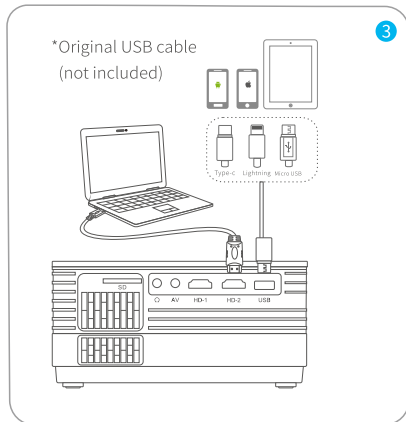

\*Original USB cable  
(not included)

Connect your device to the projector correctly.

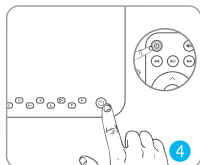

Press the **Power Button** to turn on the projector.

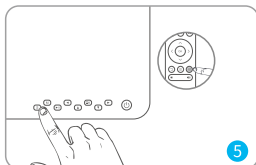

Select the correct input source by pressing the button **S** / **→**.

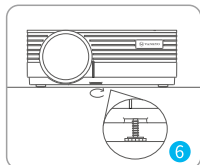

Adjust the kickstand accordingly.

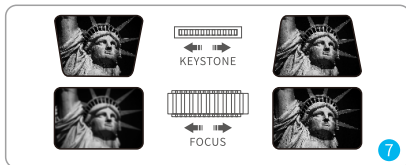

Adjust the keystone and focus ring to get the best image performance.

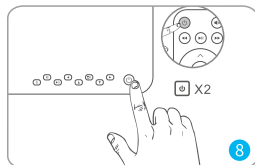

Press the **Power Button** twice to turn off the projector.

# INPUT SOURCE

Press **S** /  on the projector or remote to enter the interface of Input Source.

## A. Multimedia Connection

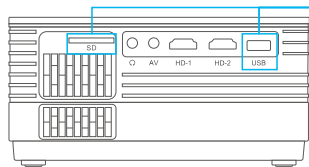

Input Source
VGA
HD1
HD2
Screen Mirroring
AV
SD
USB

## B. HD Connection

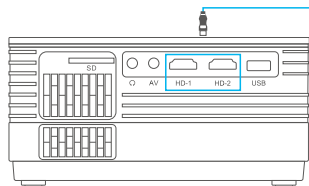

Input Source
VGA
HD1
HD2
Screen Mirroring
AV
SD
USB

## C. VGA Connection

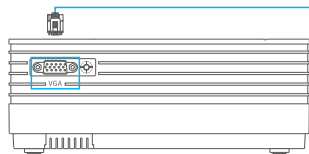

Input Source
VGA
HD1
HD2
Screen Mirroring
AV
SD
USB

### D.Screen Mirroring

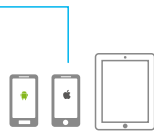
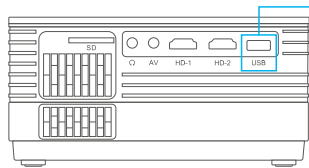

Input Source
VGA
HD1
HD2
Screen Mirroring
AV
SD
USB

## PROJECTOR CONNECTIONS

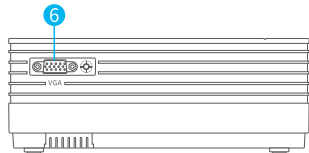
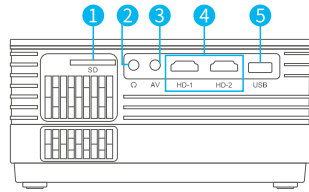

1

2

3



4

5

6

# SCREEN MIRRORING

## Important:

Before screen mirroring, please press the  /  button on the projector/remote to enter the interface of **Input Source** and select **Screen Mirroring**.

## Screen Mirroring through Wireless Connection

### For iOS System

\* Streaming with cellular data

1. Turn on the projector, select **Screen Mirroring** as the input source to enter the interface of **Screen Mirroring for iOS System**.



2. Go to the settings of your iOS mobile device and connect it to the WiFi of LEISURE470-XXXXXX (pwd: 12345678). Please ignore the exclamation mark before it.
3. Activate **Screen Mirroring/AirPlay Mirroring** on your iOS mobile device and search for the projector.

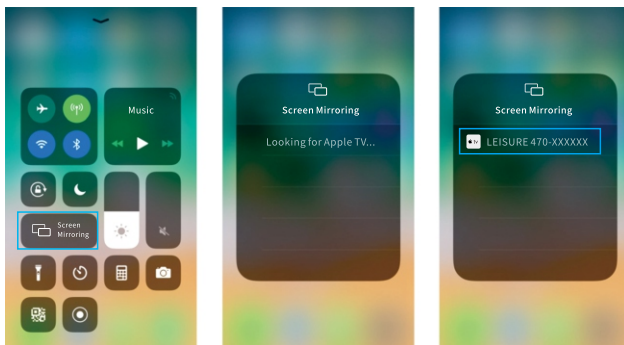

4. Select LEISURE470-XXXXXX from the searching results to connect.
5. The display of your iOS mobile device will be projected to the wall/screen via cellular data after a successful connection.

#### \* Streaming with your router's WiFi

1. Turn on the projector, select **Screen Mirroring** as the input source to enter the interface of Screen Mirroring for iOS System.



2. Go to the settings of your iOS mobile device and connect it to the WiFi of LEISURE470-XXXXXX (pwd: 12345678).
3. Visit <http://192.168.49.1> from a browser on your mobile device, tap **WiFi AP > Scan**, select your router's WiFi and enter the right password, then tap **Connect** to continue.



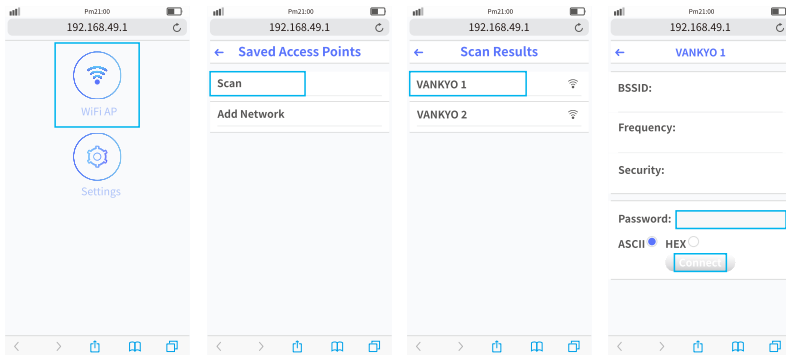

4. Your router's WiFi will be displayed on interface of Screen Mirroring for iOS System after a successful connection.



5. Get back to the WiFi setting of your iOS mobile device, then connect it to the same router's WiFi.
6. Activate **Screen Mirroring** on your iOS mobile device and search for the projector, then select LEISURE470-XXXXXX from the searching results to connect.
7. The live streaming content from your iOS mobile device will be projected to the wall/screen through WiFi connection.



**Tip:** If you'd like to connect to another router's WiFi, please repeat the procedures mentioned in the section of **Streaming with your router's WiFi**.

## For Android System

To activate this function, your android device must support **Multi-Screen/Wireless display**. Names may differ from different devices.

1. Turn on the projector, select **Screen Mirroring** as the **Input Source**, then press the OK button on the projector/remote to switch to the interface of Screen Mirroring for Android System.



2. Turn **ON** the WiFi Switch in your Android device. Successfully connected WiFi on Android device is not a must unless the live streaming content is needed.
3. Activate **Multi-Screen** function on your Android device and search for the projector.
4. Select **LEISURE470-XXXXXX** from the searching results to connect.
5. Your Android device display will be projected to the wall/screen after a successful connection.

### Notes:

- 1 The fluency of screen mirroring with wireless connection will be affected by the network environment. A bandwidth of 100Mbit or more is recommended when using screen mirroring.
- 2 Make sure your mobile device is close to the projector when using wireless connection. A distance within 1 meter is recommended.
- 3 Some mobile devices may not support screen mirroring due to the compatibility.

## \* Upgrade the Firmware Version of Screen Mirroring

When there is a newer version, you will see **Discover new firmware...** on the projected screen, please press **OK** button on the projector/remote and follow the steps to upgrade the firmware version of screen mirroring as needed.



### Notes:

- 1 Make sure the projector is connected to WIFI and **DO NOT** power off during updating.
- 2 It takes around 6-8 minutes for the update completes, please wait patiently.
- 3 The screen mirroring system will restart once the upgrade is completed.



### Tip:

After entering the interface of **Screen Mirroring for iOS system**, you can press and hold the **OK** button to reset the firmware version of screen mirroring.

## Screen Mirroring with the USB Cable

### For iOS System

1. Turn on the projector, select **Screen Mirroring** as the input source to enter the interface of **Screen Mirroring for iOS System**.
2. Connect your iOS mobile device to the USB port of the projector with the **ORIGINAL** lightning cable.
3. Select **Trust** in the pop-up window of **Trust This Computer**.

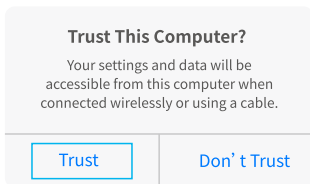

4. The display of your iOS mobile device will be projected to the wall/screen after a while.

### For Android System

1. Turn on the projector, select **Screen Mirroring** as the input source, then press the **OK** button on the projector/remote to switch to the interface of **Screen Mirroring for Android System**.
2. Go to the settings of your mobile device, find **Developer options** and turn on **USB debugging**.

#### Tip:

The steps to turn on **Developer options** vary from different models of Android device. You may check it from Internet or contact us for the detailed steps. We take **Samsung Galaxy S8+** as an example.

- \* Go to settings of your Android device, then tap **About phone** > **Software information** > **Build number**.
- \* Continuously tap on **Build number** for several times until it shows **Developer mode had been turned on**.
- \* Get back to the settings of your mobile device, it will show **Developer options**.

3. Connect your Android mobile device to the USB port of the projector with the **ORIGINAL** USB cable.

4. Tap **OK** when your Android mobile device pops out the window of **Allow USB debugging?**, then your Android device will be projected to the wall/screen.

### Allow USB debugging?

USB debugging is intended for development purposes only. It can be used to copy data between your computer and your device, install application, and read log data.

CANCEL

#### Notes:

- 1 The USB cable **MUST** be the **ORIGINAL** cable or the cable which can transfer the data, otherwise screen mirroring may fail. You can plug the cable into your laptop to check the availability of transferring the data.
- 2 Some mobile devices may not support screen mirroring due to the compatibility.
- 3 Some Android mobile devices may only transfer the display without audio due to the protocol restrictions.

## PROJECTION DISTANCE&SIZE

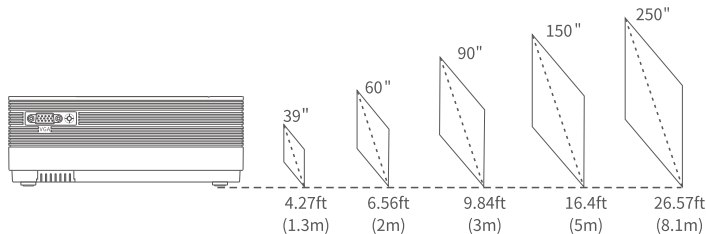

\* The recommended projection distance varies with different projection contents. Please adjust the distance between the wall/screen and the projector properly as needed.

\* Ambient darkness will improve the clarity of the projected images.

## SPECIFICATION

Display Technology	LCD	Light Source	LED
Resolution	Native 1280 x 720	Input Signal	576i/720P/1080i/1080P
Aspect Ratio	4:3/16:9/Auto	Focus	Manual
Keystone	±15°	Installation Type	Front/Rear/Ceiling
Speaker	3W/4ohm	Power Supply	AC 100-240V, 50/60Hz
Unit Dimension	221 x 168 x 84 mm (8.7 x 6.6 x 3.3 inches)	Unit Net Weight	1.35kg (2.98lb)
Photo Format Supported	BMP/JPG/PNG/GIF/JPEG	Audio Format Supported	MP3/WMA/MP2/AAC/FLAC/PCM
Video Format Supported	AVI/MP4/MKV/FLV/MOV/ RMVB/3GP/MPEG/H.264/ XVID	Ports	HD In x 2/USB Port x 1/Audio Out x 1/ AV In x 1/VGA Port x 1/Memory Card Slot x 1
Mounting Screws	M4 Metric	Screw Number	3

## TROUBLESHOOTING GUIDE

- 1 The content from Hulu, Netflix, and similar services can not be mirrored or cast.**

  - \* Due to the copyright restriction from Hulu, Netflix, and similar services, the contents MAY NOT be mirrored or cast.
- 2 What should I do if I want to watch the content from Hulu, Netflix, and similar services via the projector?**

  - \* Please prepare a Fire TV stick , Roku stick or Chromecast™ (not included), then connect it to the projector to watch the content.
- 3 Blurry Image**

  - \* Adjust focus ring/keystone.
  - \* Projector and screen/wall must be in effective distance.

#### 4 Remote Unresponsive

- \* Make sure the remote points at the IR receiver directly.
- \* Do not cover IR receiver.
- \* Try a new pair of AAA batteries.

#### 5 Upside Down Images

- \* Go to **Menu > PICTURE > Projection Direction** to flip the projection image.

### FCC Statement

Any Changes or modifications not expressly approved by the party responsible for compliance could void the user's authority to operate the equipment. This device complies with part 15 of the FCC Rules. Operation is subject to the following two conditions:

- (1) This device may not cause harmful interference, and
- (2) this device must accept any interference received, including interference that may cause undesired operation.

**NOTE:** This equipment has been tested and found to comply with the limits for a Class B digital device, pursuant to part 15 of the FCC Rules. These limits are designed to provide reasonable protection against harmful interference in a residential installation. This equipment generates, uses and can radiate radio frequency energy and, if not installed and used in accordance with the instructions, may cause harmful interference to radio communications. However, there is no guarantee that interference will not occur in a particular installation. If this equipment does cause harmful interference to radio or television reception, which can be determined by turning the equipment off and on, the user is encouraged to try to correct the interference by one or more of the following measures:

- Reorient or relocate the receiving antenna.
- Increase the separation between the equipment and receiver.
- Connect the equipment into an outlet on a circuit different from that to which the receiver is connected.
- Consult the dealer or an experienced radio/TV technician for help.

This equipment complies with FCC radiation exposure limits set forth for an uncontrolled environment. This equipment should be installed and operated with minimum distance 20cm between the radiator& your body.

This transmitter must not be co-located or operating in conjunction with any other antenna or transmitter.

### ISED Warning

This device complies with Industry Canada licence-exempt RSS standard(s). Operation is subject to the following two conditions:

- (1) this device may not cause interference, and
- (2) this device must accept any interference, including interference that may cause undesired operation of the device.

Le présent appareil est conforme aux CNR d'Industrie Canada applicables aux appareils radio exempts de licence.

L'exploitation est autorisée aux deux conditions suivantes:

- (1) l'appareil ne doit pas produire de brouillage, et
- (2) l'utilisateur de l'appareil doit accepter tout brouillage radioélectrique subi, même si le brouillage est susceptible d'en compromettre le fonctionnement.

The device is compliance with RF exposure guidelines, users can obtain Canadian information on RF exposure and compliance.

The minimum distance from body to use the device is 20cm.

Le présent appareil est conforme

Après examen de ce matériel aux conformité ou aux limites d'intensité de champ RF, les utilisateurs peuvent sur l'exposition aux radiofréquences et la conformité and compliance d'acquérir les informations correspondantes.

La distance minimale du corps à utiliser le dispositif est de 20cm.

#### CAUTION



The symbol indicates AC voltage



RECYCLING

This product bears the selective sorting symbol for Waste electrical and electronic equipment (WEEE).

This means that this product must be handled pursuant to European directive 2012/19/EU in order to be recycled or dismantled to minimize its impact on the environment.

User has the choice to give this product to a competent recycling organization or the retailer when he buys a new electrical or electronic equipment.

This product can be used across EU member states.

The device is low power device, it can meet the requirement of the RF exposure.

EU Compliance Statement: Shenzhen VanTop Technology & Innovation Co., Ltd. hereby declares that this device is in compliance with the essential requirements and other relevant provisions of the Directive 2014/53/EU.

A copy of the EU Declaration of Conformity is available online at <https://doc.vantop.com/>.



## VANKYO SUPPORT

North America [support@ivankyo.com](mailto:support@ivankyo.com)

United Kingdom [support.uk@ivankyo.com](mailto:support.uk@ivankyo.com)



[www.ivankyo.com](http://www.ivankyo.com)



[@VankyoOfficial](https://www.facebook.com/VankyoOfficial)



[VANKYO](https://www.youtube.com/VANKYO)