

Battery Powered Camera

Service email: support-us@cooau.com



Scan “Cooau.com” QR
code to contact us



Follow @Cooau.Official
on Facebook

 www.cooau.com

 [Cooau_official](#)

 [Cooau_official](#)

 [Cooau.Official](#)

 [Cooau_official](#)

 [lu/Cooau](#)

FCC Statement

This equipment has been tested and found to comply with the limits for a Class B digital device, pursuant to part 15 of the FCC rules. These limits are designed to provide reasonable protection against harmful interference in a residential installation.

This equipment generates, uses and can radiate radio frequency energy and, if not installed and used in accordance with the instructions, may cause harmful interference to radio communications. However, there is no guarantee that interference will not occur in a particular installation. If this equipment does cause harmful interference to radio or television reception, which can be determined by turning the equipment off and on, the user is encouraged to try to correct the interference by one or more of the following measures:

- Reorient or relocate the receiving antenna.
- Increase the separation between the equipment and receiver.
- Connect the equipment into an outlet on a circuit different from that to which the receiver is connected.
- Consult the dealer or an experienced radio/TV technician for help.

Responsible for compliance could void the user's authority to operate this equipment. (Example- use only shielded interface cables when connecting to computer or peripheral devices).

Any Changes or modifications not expressly approved by the party responsible for compliance could void the user's authority to operate the equipment.

This equipment complies with Part 15 of the FCC Rules. Operation is subject to the following two conditions:

- (1) This device may not cause harmful interference, and;

(2) This device must accept any interference received, including interference that may cause undesired operation.

FCC Radiation Exposure Statement:

The equipment complies with FCC Radiation exposure limits set forth for uncontrolled environment. This equipment should be installed and operated with minimum distance 20cm between the radiator and your body.

(FCC ID: 2AA94-CX20X)

CONTENT

1. After-Sale Support	1
2. Packing List	2
3. Product Introduction.....	3
4. APP Installation and Account Registration	4
4.1 Download 'CloudEdge' APP	4
4.2 Register Account	4
5. How to Add Camera to APP.....	6
5.1 Install Micro SD card	6
5.2 Connect the camera	6
5.3 Power on camera	7
6. Function Introduction	11
6.1 APP Interface Introduction.....	11
6.2 P2P user sharing.....	14
6.3 Alert Settings	16
6.4 Alarm Push Notification and Playback.....	18
7. Battery Management	19
8. Camera Installation	19
9. How to Reduce False Alarms.....	20
10. Trouble Shooting.....	21
11. FAQ.....	22

1. After-Sale Support

Thanks for you purchasing our COOAU battery WIFI security camera. We provided 12 months warranty. If you have any problems or suggestions, please feel free to contact us by Amazon message or send e-mails to our official mailbox

support-us@cooau.com. The best service will be offered to you.

Note:

- The camera only supports 2.4GHz WIFI, it doesn't support 5GHz WIFI.
- The battery is 18650.
- Please ensure that the Wi-Fi signal strength is to be over than 85%; if the camera is far away from the signal source, it won't be connected successfully for the first time.
- If your router is connected with too many devices, the camera will fail to connect Wi-Fi because of the IP address conflict.
- This wireless camera does not support PC Browser and Software.
- This wireless camera supports events recording when Wi-Fi disconnected.
- Video playback works in CloudEdge APP only. It does not support the 3rd party player.
- Manually snapshot and recording files are saved in mobile. Events snapshot files are saved in Cloud. Events recording files are saved in Micro SD card.
- It will consume the batteries' power if you watch live footage or the recorded videos from the SD card.

2. Packing List

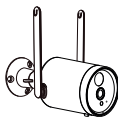

1*Battery Camera

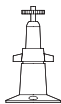

1*Metal Mount

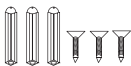

1*Screws Sets



1*USB cable



1*Quick User Guide

3. Product Introduction

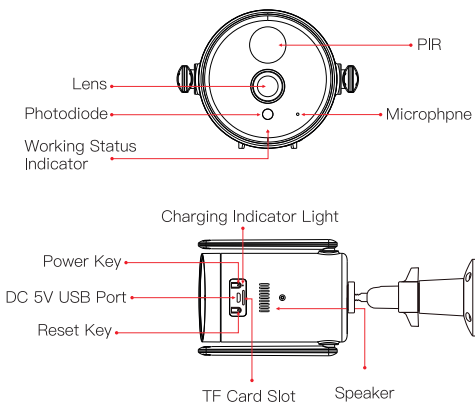

Camera Keys	Operations
Power key	Press and hold for 5s for power on/ power off the camera
Power key	Quick press 1s to wake up the camera from standby mode
Reset key	Press and hold for 5s to reset or restore to factory settings
Reset key	Quick press 1 second to enter AP distribution network mode
Condition	Meaning
Slow flickering Red	Awaiting Wi-Fi connection and start adding devices
Fast flickering Red	Wi-Fi connecting

Solid on Red	Network is abnormal
Solid on Blue	Wi-Fi connected successfully, the camera running normally
Slow flickering Blue	AP mode

4. APP Installation and Account Registration

4.1 Download 'CloudEdge' APP

Method 1: Download 'CloudEdge' APP from APP Store (iOS) or Google Play (Android);

Method 2: Scan 'CloudEdge' APP QR code to download it.

Download on
the App Store



GET IT ON
Google Play



Tips: Please turn on 2 below permissions while using this APP for the first time.

1. Allow 'CloudEdge' APP to access mobile cellular data and wireless LAN **or it will fail to add IP camera.**
2. Allow 'CloudEdge' APP to receive pushed message **or the phone will not receive alarm push when motion detection or audible alarm is triggered.**

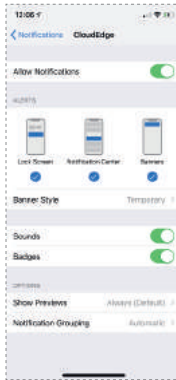

4.2 Register Account

New users need to register by email. The concrete steps are as following:

- 1) Click "Register";
- 2) Follow the steps to complete the registration of the account;
- 3) Log in.

Note:

- When registering a new account, please choose the region which you are actually in. (Different registered regions can't share the camera.)
- Please choose to register by e-mail.

5. How to Add Camera to APP

5.1 Install Micro SD card

Please insert Micro SD card to record videos when motion detected and playback. (Micro SD card is not included; the camera supports up to 128GB Micro SD card)

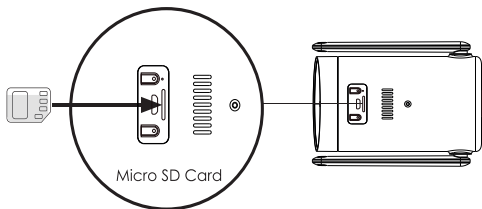

Note: Please insert the Micro SD card before power on, otherwise, the SD card can not be detected.

5.2 Power on camera

Press and hold on the power button for 5s to turn on camera (If it can't be powered on, please plug in DC 5V 2A power adapter to charge the camera for 15min first).

The indicator with red light blinking slowly means the camera is started successfully.

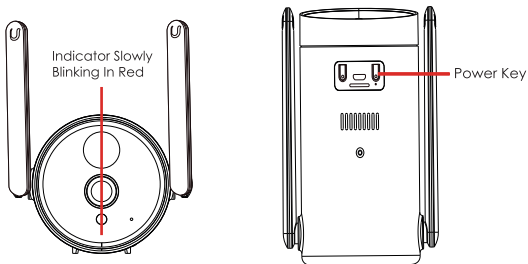

Note: DC 5V 2A power adapter is not included in the packing list.

5.3 Connect the camera

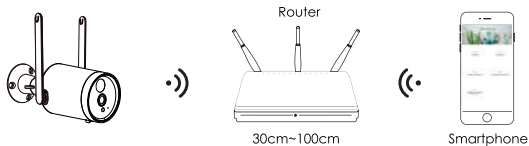

Note: Put the camera and smart phone 1 to 3 feet (30 to 100 cm) away from the router to set Wi-Fi.

Note: The camera only supports 2.4GHz Wi-Fi, it doesn't support 5GHz Wi-Fi.

Wi-Fi Connection Steps:

(1) Before connecting the camera, please press and hold the reset button for **5 seconds** to reset or restore factory. When you hear the sound of "**Boogu**", that's mean resetting successfully.

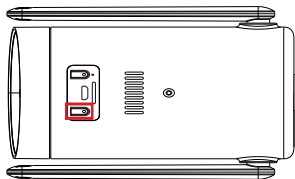

Reset Button

(2) Run CloudEdge App, click “+” and select “**Battery Camera**”; According to the guide on APP, please ensure the camera was activated. (The LED indicator light is turning red and flickering slowly)

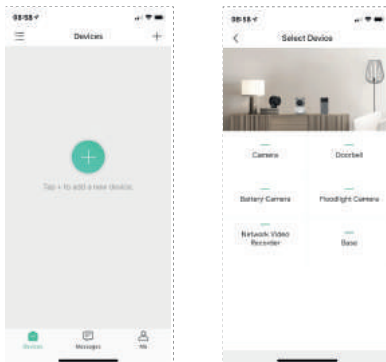

(3) After entering the 'Add Battery Camera' interface, click 'Next'; when entering the next interface, click 'Next' again;

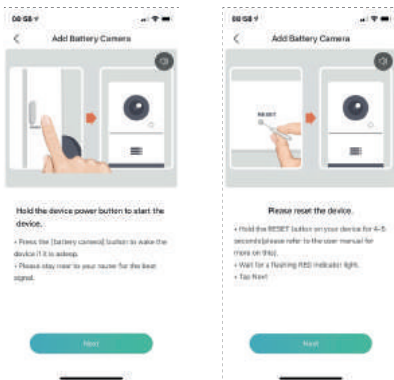

(4) Select 2.4GHz Wi-Fi SSID and input Wi-Fi password, and then click 'ok' ;



(5) After entering the following operation interface , please click "Next" and you will see the "Scan QR Code" interface.

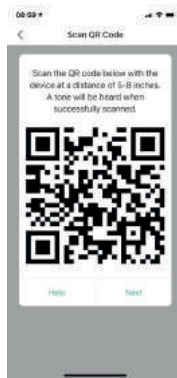

(6) Put the QR code in front of the camera lens about **15cm**. The device lens is aimed at the QR code on the phone screen with a distance of 15cm. After the device recognizes the QR code, the camera will make a sound 'Boogu'. After heard it, please click 'next'.

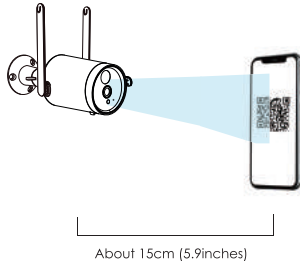

(7) Then, the camera will start connecting Wi-Fi. After the connection finished, it will skip to '**Device Found**' page, you could edit the camera name and click '**Done**', and then go to your device list and start viewing videos.

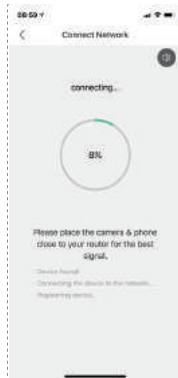

6. Function Introduction

6.1 APP Interface Introduction

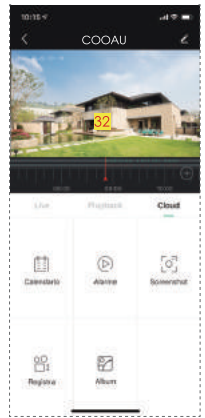
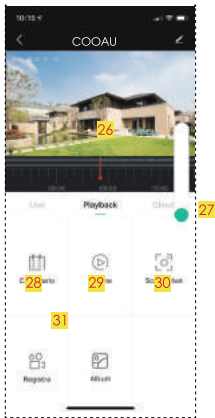
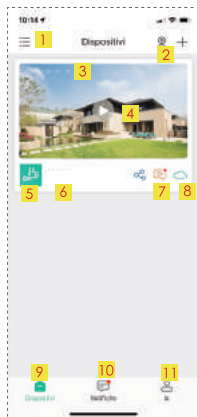

1. Choose the device display interface	2. Add a camera & Multi-screen viewing	3. Camera time
4. Live view button	5. Camera type icon	6. Camera name
7. Alarm information icon (red dot indicates alarm occurred. Click it to view alarm screenshot or video)	8. Cloud storage (7 days cloud storage service for free)	9. My device list
10. Messages (Alarm messages & System messages)	11. Personal homepage	12. Camera settings options, such as SD card, alarm setting, etc.
13. Battery capacity	14. Sound option (Speaker)	15. SD,HD option
16. Full screen option	17. Bit rate	18. Network signal strength
19. Preview option	20. Playback option	21. Related to cloud storage
22. Screenshot button	23. Intercom option, long press it to talk	24. Record button
25. Motion Detection option, it's on by default (green means activated)	26. Alarm video, click it to play/pause	27. Electronic amplification
28. Calendar option, click it to select the date	29. Screenshot options	30. Recording options
31. Alarm point, view all mobile alarm recordings	32. Red vertical line means alarm video	

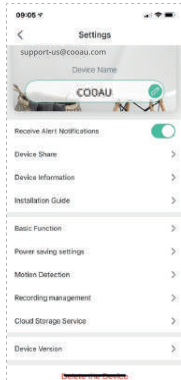

Receive Alert Notifications: Open it to receive the notifications.

Device Share: Share the camera with the users who is registered in the same region.

Device Information: Check to view 'Network Name', 'Signal Strength', 'Virtual ID', 'IP', 'Mac Address' and 'Timezone'.

Installation Guide: Choose a proper place to install camera which has high wifi sign strength.

Basic Function: (1) Network Indicator: On/off; (2) Speaker Volume: 0-100 for you to choose; (3) Open it and the picture will be rotated 180°; (4) Night Vision: Choose the night vision mode

(Automatic/On/Off); (5) Power Management: Display remaining battery capacity information and estimated time available.

Power Saving Settings: Setting the shooting interval and maximum shooting time.

Motion Detection: 'Motion Detection' on/off , 'Alarm sensitivity adjustment' (Low/High), 'Alarm Interval' (set alarm interval) , 'Alarm only when people appear' on/off, 'Alarm Plan' (set the alarm time).

Recording Management: Setting recording time (20 seconds, 40 seconds, 1 minute) ; Display the total capacity and remaining capacity of SD card; support one-click format SD card in the CloudEdge app).

Cloud Storage Service: Free 7-day cloud storage experience.

Device Version: Check the current and the newest version, and support one-click upgrade.

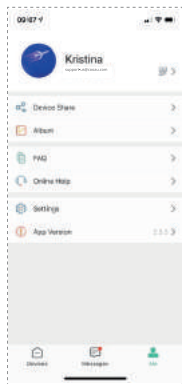

Device Share: Share your cameras to other users

Album: View pictures and videos from recording and screenshot manually; delete pictures and videos batchly.

FAQ: Common problems and solutions.

Online Help: online technical support

Setting

In-App Alert Sound: on/off

Clear Cache: Clear the cache in APP

Deactivate Account: Permanently disabled on

App Version: The current APP version

6.2 P2P user sharing

(1) Please sign up a new account on your friend's phone. (the same steps as you created your account, please choose the same country)

(2) Access your APP 'Me', click 'Device Share' to choose the camera which you want to share, click 'Add' then scan or input your friend's account to add his account.

(3) Accept the friend request on your friend's phone, you can see it from 'Messages - System Messages' on your friend's phone.

(4) Refresh the APP's interface on your friend's phone to view the camera.

(5) Access your friend's phone camera setting to open 'Receive Notifications'.

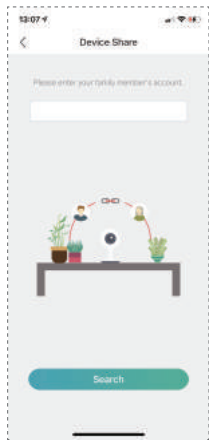
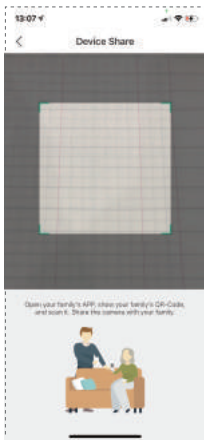
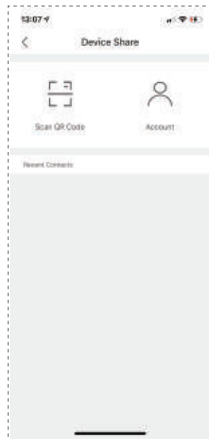
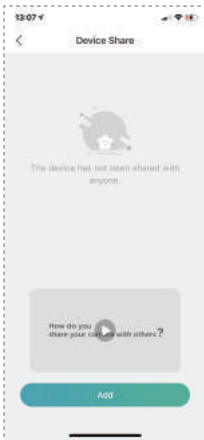

Note: When you have a sharing, please make sure the APP account is registered in the same regions. Otherwise, you won't share successfully.

6.3 Alert Settings

PIR 'Motion Detection' is on by default and the default sensitivity is 'Low', but it is adjustable.

Alert settings steps: 'My Device' -> 'Motion Detection'.

Tips: The detecting distance is 4 meters (13ft).

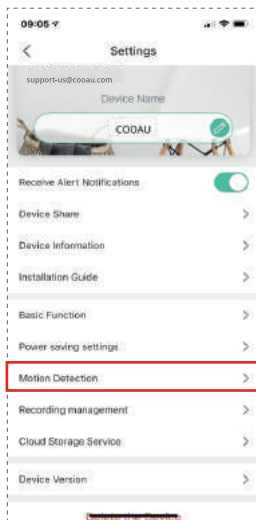
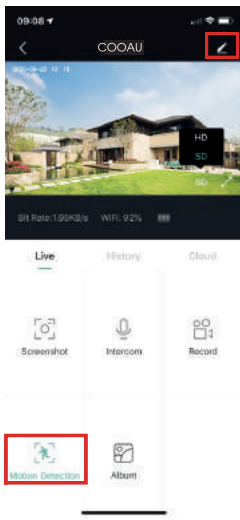

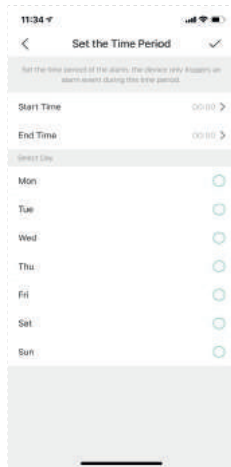
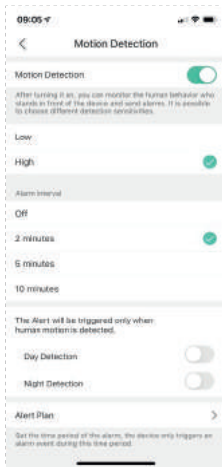

Sensitivity	Detecting Distance (For moving objects)
Low	Up to 4 meters(13 ft)
High	Up to 8 meters(26 ft)

Note: Higher sensitivity offers longer detecting distance, but it would lead to more false alarms. You are advised to set up the sensitivity level to 'Low' when you install the camera outdoors.

6.4 Alarm Push Notification and Playback

Wireless camera with PIR sensor is not designed for 7 X 24 all day recording, but aims at pushing alarm message notification to app and recording video to Micro SD card or capturing a screenshot to Alicloud (Need to pay) when PIR sensor detected human body motion events. Then, you can playback the motion videos wherever you are via CloudEdge APP.

When PIR is triggered, camera and system actions:

1. Alarm Sound in APP (Please turn on permission for CloudEdge APP notification in mobile setting and turn mobile volume on)
2. Alarm Message Notification (Please enable CloudEdge APP notification in mobile setting)
3. Alarm snapshot and video will be recorded on Micro SD card (Please insert micro SD card) or Alicloud (Need to pay)

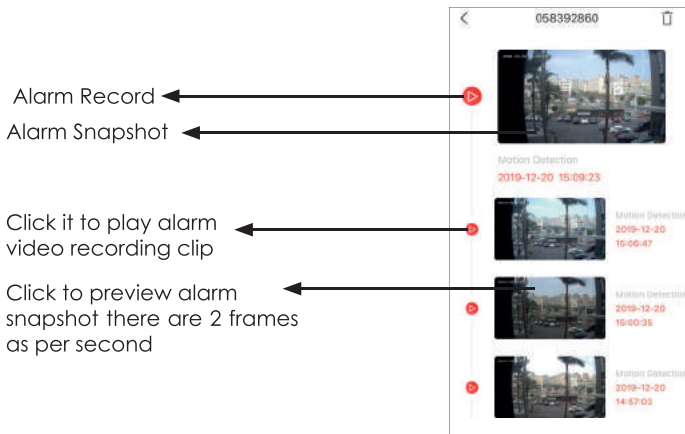

7. Battery Management

- The camera has built-in 10400 mAh 18650 batteries, which can be used for about 4 months in theory, assuming the camera wakes up 10 times per day and watching 10 minutes of video.

(**Note:** The life of the battery depends on the times of the camera's wake up. The more the times of wake-up, the faster the battery capacity is consumed.)

- If the battery capacity is less than 20%, the app will send an alarm message to remind you to charge in time.

- You can charge the camera with DC 5V 2A power adapter.

- If your battery capacity is consumed too fast, it is probably because the camera is woken up too frequently. It is recommended to lower down the 'Motion Detection' sensitivity or turn it off occasionally.

8. Camera Installation

You can put it on any flat place: Table, Chair, Floor, etc.

How to install with wall mount:

Fix the bracket to the wall with screws and wall anchors by using a drill or a screwdriver, and then rotate the camera into the bracket. You can adjust the angle of the camera by loosen and tighten the rotary knob on the bracket.

Tips:

- Please make sure the wall or surface where you want to install the camera is flat. For easier installation, it is suggested to use drill. Concrete wall may not suitable for the installation.

- When installing the camera, it's not suggested to make the PIR sensor vertically face the moving object, otherwise, it may not detect the motion events. It is suggested to make the angle between PIR sensor and detected object larger than 10 degree.

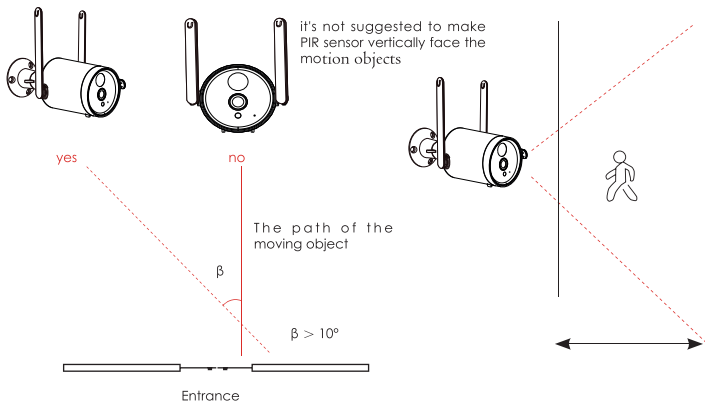

9. How to Reduce False Alarms

To reduce false alarms, please note that:

- Do not install the camera in a position facing any objects with bright lights, including sunshine, bright lamp lights, etc.
- Do not place the camera too close to a place where there are frequently moving vehicles. Based on numerous tests, the recommended distance between the camera and vehicle is 15 meters (55 ft).
- Stay away from the outlets, including air conditioner vents, humidifier outlets, the heat transfer vents of the projectors, etc.
- Do not let the camera face the mirror.
- Keep the camera at least 1 meter away from any wireless devices in order to avoid wireless interference, including Wi-Fi routers and phones.

10. Trouble Shooting

No.	Description	Solution and Operation
1	Unable to connect	(1) Check your Wi-Fi name and password (2) Ensure your Wi-Fi is 2.4GHz, not 5GHz. (3) Ensure your camera and phone close to router(30-100cm)
2	Reset succeed or not	(1) Press and hold the reset button for 5 seconds (2) Hear "boogu" sound (3) Red light turns to slow blinking
3	Change to a new network	(1) Press reset key to factory default setting (2) Re-connection
4	Alarm picture without people	(1) The camera takes time to wake up (about 4s); (2) People move too fast. (3) Some objects around 36°C is moving in the picture
5	No alarm push	Enable CloudEdge APP notification in mobile setting
6	No alarm video record	Please insert SD card
7	Device offline	Check if the network transferring fluency processes well
8	Browse video delay	Check the Wi-Fi network; the distance between the camera and the router should not be too far
9	Short battery life	(1) The camera has been waken up too many times (2) It should not be installed on the side of the road or exposed to the sun

11. FAQ

1. How to delete the photos and videos?

Select 'Me' -- 'Pictures & Videos' -- Selected -- Delete

2. How long do I need to charge the built in battery for a full charge?

The wireless camera charger supports DC 5V 2A plug.

Please charge it more than 15 hours before you use it, it need FULLY charge before first use.

10400mAh fully charged by 5V 2A DC power adapter: about 8 hours

3. How to talk to camera and listen to the camera?

Hold the intercom key to talk to, and enable the audio key on. Then, you can listen to the camera.

Step 1: Enable audio option

Step 2: Hold 'Intercom' key to talk.



4. How to charge the security camera?

(1) Remove the waterproof plug;

(2) Align the USB icon on the camera to guarantee that the power cable is inserted into the USB port.

(3) Use 5V 2A power supply and connect with the power cable. Then, plug it into the socket.

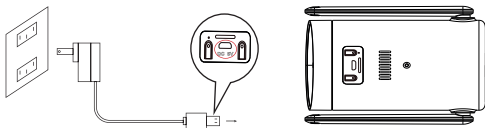

5. What effect of hot or cold weather on battery life?

It handles temperature range between -13 °F and 140 °F (-25°C to 60°C).

Outside temperature below minus 20 degrees may affect the performance of the battery which may affect the camera work.

6. What is the difference between the red and green lines in the history display?

It will record 30 seconds when the camera detect motion, if the motion lasts up to 30 seconds, it will show red lines in the history display; if the motion lasts up to 10 seconds, it will show 10 seconds red lines and 20 seconds green lines in the history display.

7. How long the battery will last?

It depends on how much traffic you have.

Besides, it will consume the batteries' power if you watch live footage or the recorded videos from the SD card.

The camera has a built-in 10400 mAh 18650 battery, which can be used for about months in theory, assuming the camera wakes up 10 times per day and watching 10 minutes of video.

(Note: The life of the battery depends on the times of the camera's wake up. The more the times of wake-up, the faster the battery capacity is consumed.)

If the battery capacity is less than 20%, the app will send an alarm message to remind you to charge in time.

Please email us for better solution
instead of returning any unqualified product to Amazon
support-us@cooau.com

THANK YOU



My Moment My Passion