

MUBILIFE®



FCC ID: 2AUDF-CQ12X

## Wire-Free Security Camera

QUICK START GUIDE (D3)



# Warranty Service

Thanks for your shopping and trust.

We have been optimizing our products and improve our **lifetime customer service** to offer you a better shopping experience.

If you have any problems, please feel free to **send us an E-mail**.

We will solve your problems **within 24 hours**. In addition, your advice or suggestions will be much appreciated and welcomed.

Register via link below to get **3 Years Warranty** Extension.

<http://bit.ly/zuReg>

## Product Service

Email: Support@Mubilife.net

Distributor: Distributor@Dzees.net

## More About Us

Web: [www.dzees.net](http://www.dzees.net)

Facebook: [www.facebook.com/zumimalloffice](http://www.facebook.com/zumimalloffice)

# Contents

1. Packing List -----	P1
2. Product Appearance -----	P2
3. Download & Install App -----	P3
4. Account Registration -----	P4
5. Add Camera to App -----	P5
5.1 Preparation for Connection -----	P6
5.2 Connect Camera to App -----	P7
6. Install the Camera -----	P8
7. Battery Management -----	P10
8. Indicator Light Status -----	P10
9. Device Menu -----	P11
10. PIR Motion Detection -----	P13
11. Night Mode -----	P15

# Contents

12. Activity Zone -----	P16
13. Filter Video -----	P17
14. Two-Way Audio -----	P18
15. Share Camera -----	P18
16. Multi-Device Management -----	P20
17. Camera Reset -----	P21
18. Files Storage -----	P21
19. Product Specification -----	P22
20. Firmware Upgrade -----	P22
21. FAQ -----	P23

## 1. Packing List



Camera D3



Mounting Bracket



Charging Cable

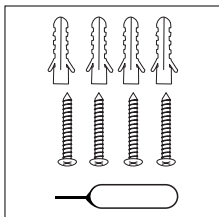

Screws Set



User Guide

## 2. Product Appearance

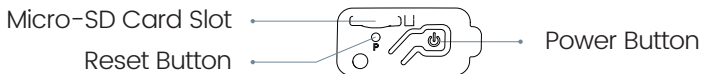
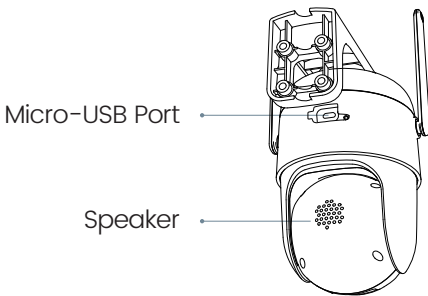
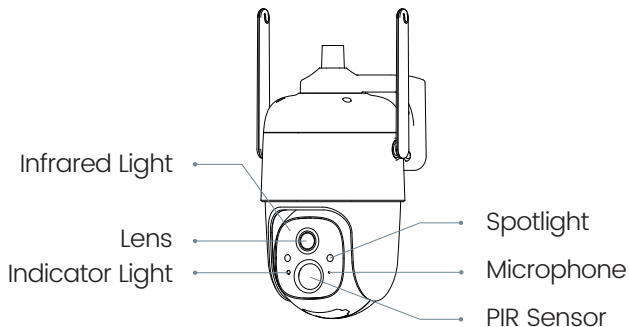

### 3. Download & Install App

The camera supports Android and iOS system.

Please scan the QR code below or search 'Dzees Home' in App store to download the App, and follow the instruction to register account. If you encounter any problems during the installation process, please feel free to contact us via Support@Mubilife.net



Dzees Home App



### 4. Account Registration

New users need to sign up by Email ID.

Click 'Sign up a New Account' and follow the steps to complete the registration.



Step 1



Step 2

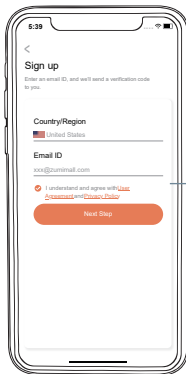

Step 3



Step 4

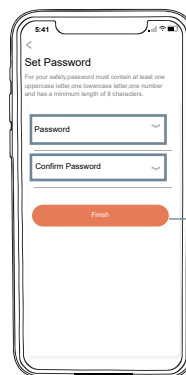

## 5. Add Camera to App

1. Allow 'Dzees Home' App to access mobile cellular data and wireless LAN, or it will fail to add camera.

2. Allow 'Dzees Home' App to receive pop-up messages, otherwise the smart phone will not receive notification when motion is detected.

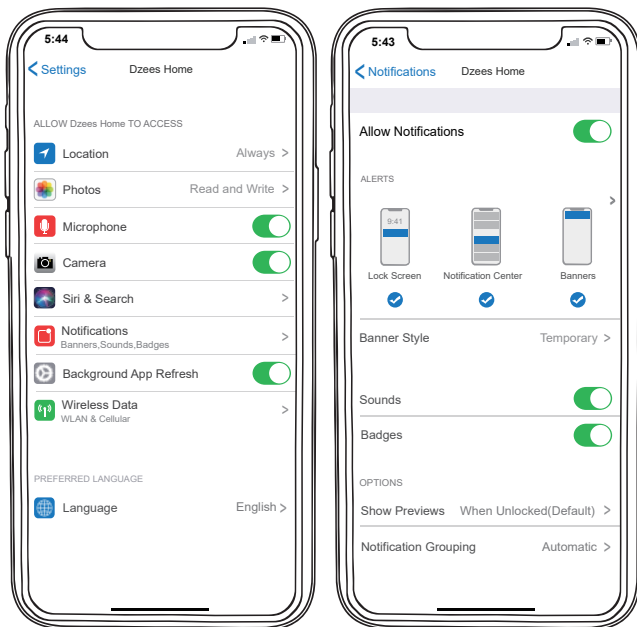

## 5.1 Preparation for Connection

1. Insert Mirco SD card when the camera is off (Supports up to 128GB.SD card not included). We also provide 7-day free cloud storage for you, the camera can work without SD Card.
2. The camera only works with 2.4GHz Wi-Fi, not support 5G.
3. Take the camera close to the router while connecting.
4. Keep pressing the power button for 2-4s to power on/off the camera.



## 5.2 Connect Camera to App

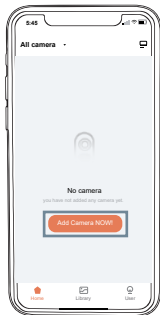

Sign in Dzees Home App, add the camera.



Turn on camera



Connect to Wi-Fi (Choose 2.4GHz Wi-Fi and input correct password)



Confirm connection mode



Turn on your camera and scan QR code

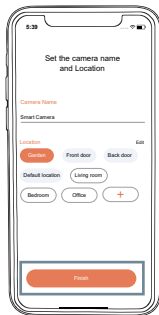

Name the camera and mark location



Setup done



Add another camera

! If you can't hear 'Ding Dong Ding Dong', please double-click the power button to enter the network configuration mode again.

## 6. Install the Camera

(1) Select a proper position for your camera.

Make sure the camera is not blocked and ensure it is in coverage of Wi-Fi.

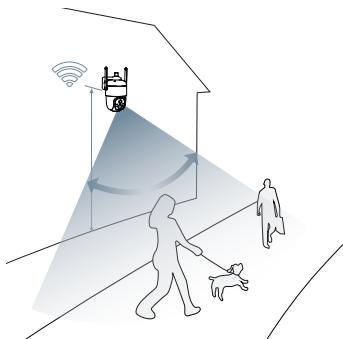
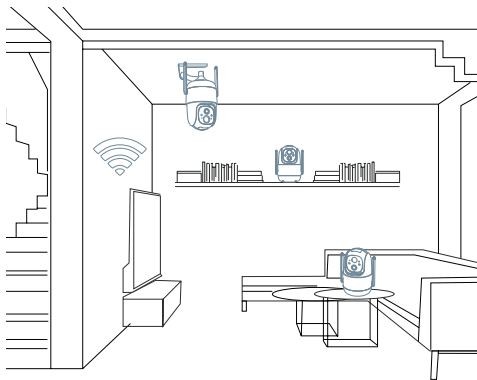

## (2) Install bracket

Step 1: Choose a clean, smooth and dry surface (avoid uneven wood leather and stucco walls).

Step 2: Stick magnetic bracket to wall surface with adhesive.

Step 3: Adjust camera to a proper angle.

Tips: To avoid falling down, it is recommended you fasten the bracket with screws.

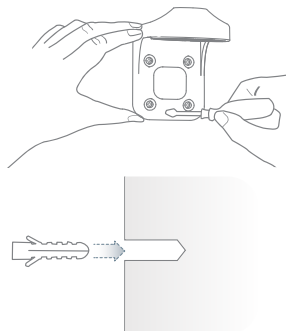
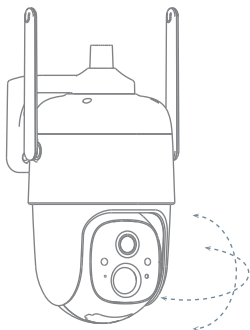

### ! To reduce false alerts, please note that:

- Do not install the camera in a position facing strong lights/mirror/window/swimming pool.
- Do not place the camera too close to any angle with busy traffic.
- Recommended distance between the camera and motion objects is within 8M (25ft)
- Stay away from the outlets, including air conditioner vents, humidifier outlets, the heat transfer vents of the projectors, etc.
- Keep the camera at least 1 meter away from any wireless devices to avoid interference, such as microwave stove or Wi-Fi routers and etc.
- If there is any motion detection delay or false alerts, please contact 24/7 after-sales service via [Support@Mubilife.net](mailto:Support@Mubilife.net)

## 7. Battery Management

1. Battery can last 3-5 months, assuming triggering of 30 times/day.
2. Charger Standard: DC 5V 2A (adapter not included).
3. It takes 8-12 hours to fully charge it. Please fully charge the camera before first use.
4. The battery durability depends on how frequently the camera is woken up. The more times the camera is woken up, the faster the battery drains. It is recommended to lower down the 'Motion Detection' sensitivity or turn it off occasionally.

## 8. Indicator Light Status

Mode	Status
Working mode	Blue
Sleep mode	Off
Charging mode	Yellow
Fully charged	Green

## 9. Device Menu

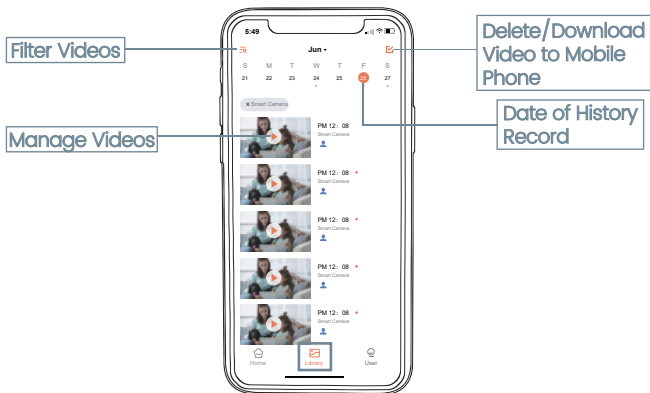



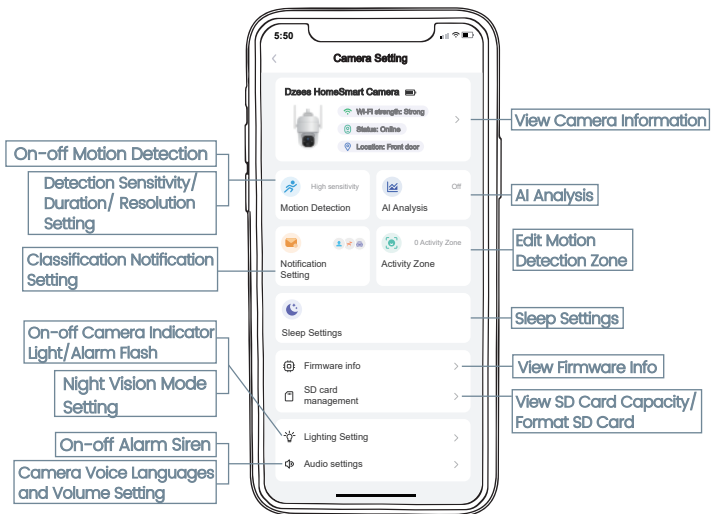
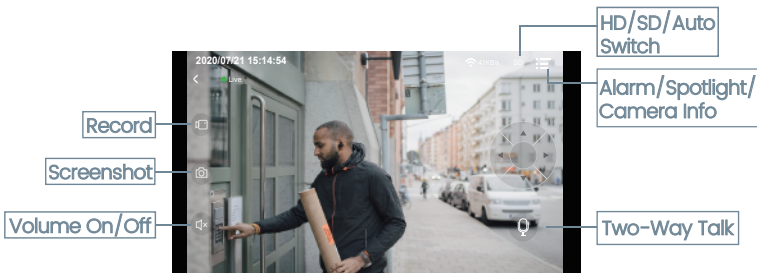

## 10. PIR Motion Detection

1. Turn on 'Motion Detection' and adjust sensitivity

PIR Motion Detection is defaulted to 'High' level. But it is adjustable.

When you turn on 'Alarm Siren' (In Sound Setting) or 'Alarm Flash' (In Lighting Setting), the camera will sound an alarm or keep flashing when motion detected.

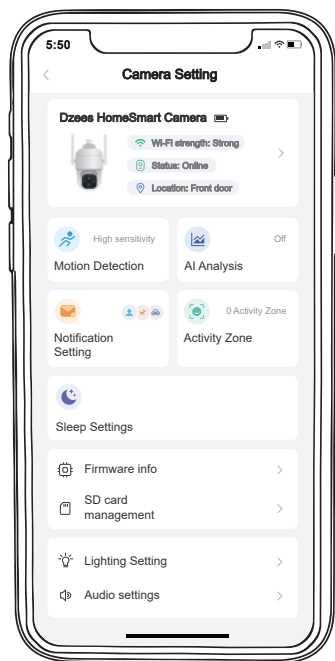

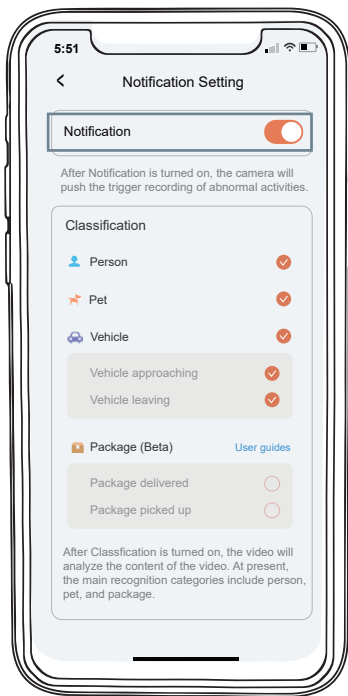
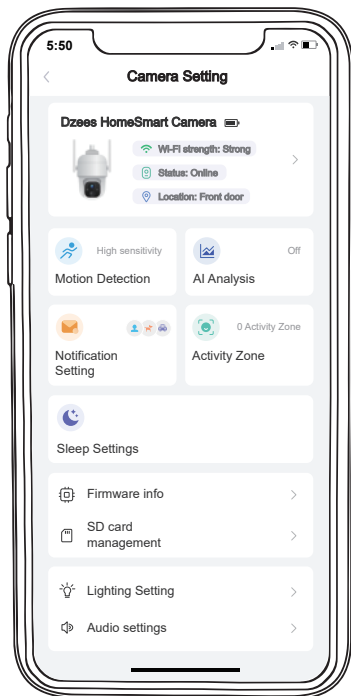

! Before turn on 'Notification', please first turn on 'Motion Detection' to receive alarm messages.

## 11. Night Mode

After Night Vision is turned on, the camera will support night viewing to improve camera shooting performance in dark environment.

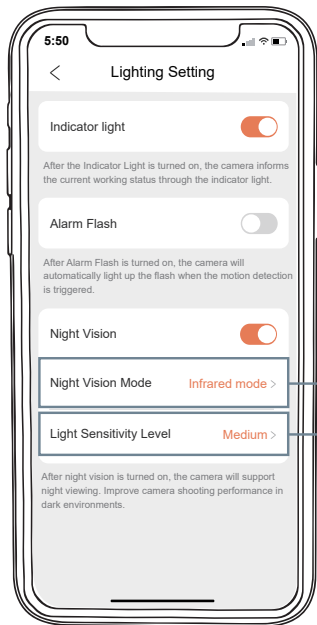

'Infrared mode' is a black and white view under night vision; 'White light mode' is a color view under night vision.

The light sensitivity level indicates the intensity of light, and it is easy to detect when high sensitivity is turned on in a dark place.

- ! 'White light mode' will turn on the spotlight at night and capture a colorful view. The spotlight will be constantly on when there is a motion detected or when living view.

## 12. Activity Zone

1. All videos will still be recorded after setting activity zones, but you will only receive notification of movements in your activity zone.
2. The principle of Activity Zone is to judge the objects activity in pointed area with combining intellegent analyse on cloud. Therefore it's a cloud-based AI.

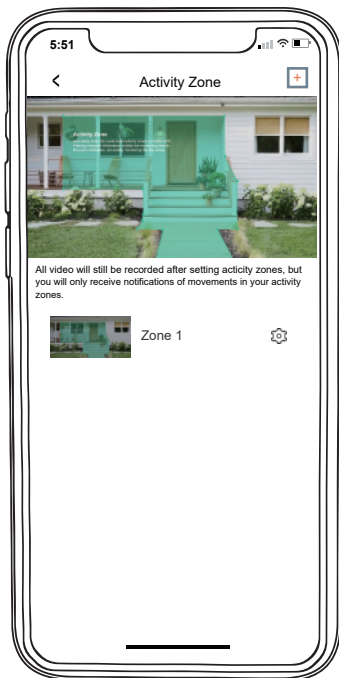
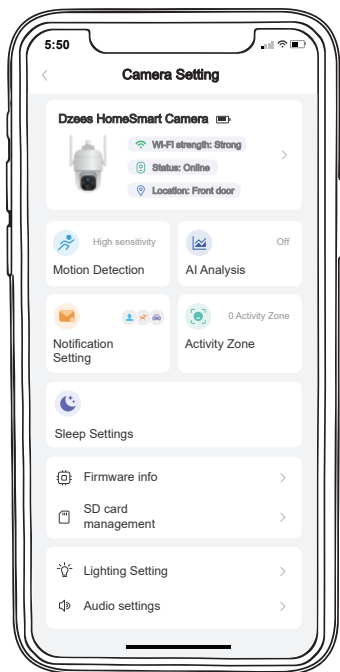

## 13. Filter Video

Select videos by camera names, tags and others.

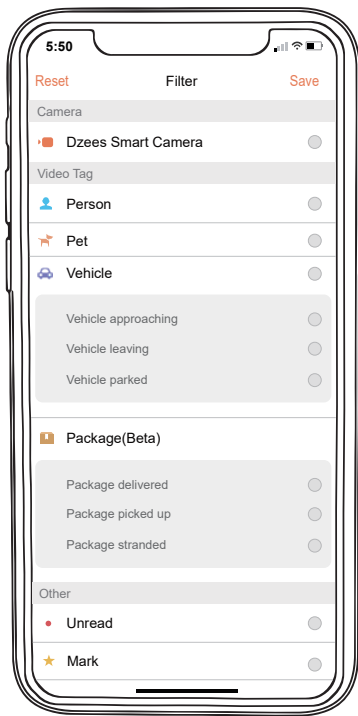
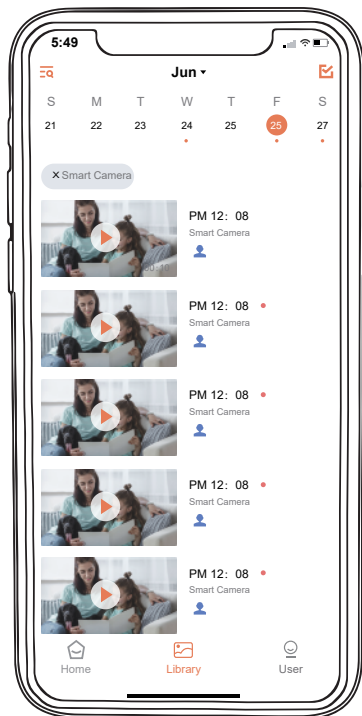

## 14. Two-Way Audio

Step 1: Activate the audio option.

Step 2: Press and hold the intercom button to speak.

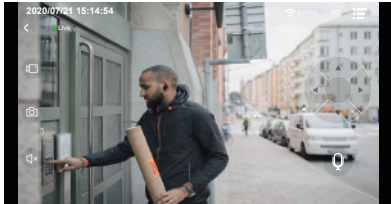

## 15. Share Camera

A is the person who shares the camera; B is the person who is shared (Register own account).

1. A enter the 'Device info' page and open the QR code.

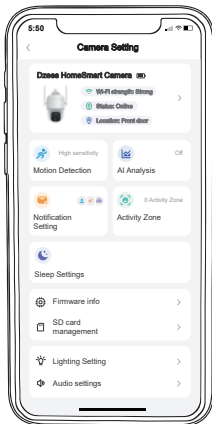

2. B enters the 'Home' page and click 'Add Friend's Camera', then scan A's QR code. After A accepts sharing, sharing is complete!





## 16. Multi-Device Management



Click '+' to add more devices

Split screen setting can watch live broadcast from multiple cameras at the same time

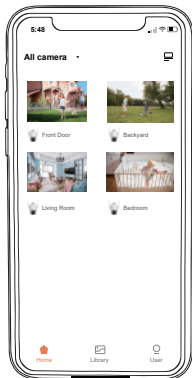

Strong Wi-Fi Connection View Multiple Cameras at the Same time



## 17. Camera Reset

1. Press reset button with the pin.
2. Double-click the power button to enter connection mode again.

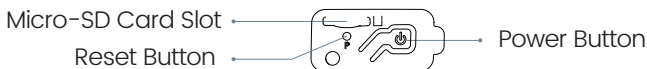

## 18. Files Storage

### Micro SD Card

1. Press buttons on both sides, and pull out the back cover.
2. Insert the Micro SD card and wait a few seconds until you hear 'SD card detected', or you can check if the Micro SD card is inserted successfully in 'Advanced Setting' (if not, try it again after turning off the camera).

### Cloud Recording

1. Cloud Recording can be subscribed on 'Dzees Home Awareness'.
2. Subscribe different service.

	No plan	Basic	Plus	Pro
Cloud Recording	7 days (≤1GB)	15 days (≤3GB)	30 days (≤5GB)	60days (≤10GB)
Intelligent Notification	✗	✓	✓	✓
Activity Zone	✗	✓	✓	✓

## 19. Product Specification

Item	Specification
Camera lens	Field of view: 130°
Resolution	1080P HD
Video bit rate	Adaptive
Storage media	Micro SD card (Up to 128GB)
Adapter requirement	5V 2A
Size	120*101*158mm

## 20. Firmware Upgrade

When you connect your camera to the 'Dzees Home' App, it will prompt you if the latest firmware is available. You can also manually check the firmware upgrade in the 'Advanced Setting' of the App.

- ⚠ Please make sure that your camera is fully charged or charging while upgrading the firmware, please do not cut off the power supply during upgradation.

## 21. FAQ

### 1. Q:How to share my camera with others?

1. Go to 'Home' page and click 'Share' in the upper right corner of this page, or click 'Setting' to get to setting interface, then click 'Share'. You will see a QR code.
2. Have him/her to download 'Dzees Home' App . Then register his/her account on App and log in.
3. Then he/she should go to 'Home' page, click '+' and select 'Add Friend's Camera'. Then scan your QR code with his/her phone.
4. You will receive a share request, then just click 'Accept' to finish sharing.

### 2. Q:What should I do if I cannot connect to the camera?

1. Make sure the camera is power enough and turned on.
2. Make sure your Wi-Fi router is 2.4GHz instead of 5GHz.
3. Make sure to enter the correct Wi-Fi name and password.
4. Take camera and phone close to your router to ensure strong signal.
5. Go to 'Home' page and click '+'. Click 'Add a new camera' and follow the steps till done.

If you cannot connect successfully, please contact us [Support@Mubilife.net](mailto:Support@Mubilife.net). We will offer solutions within 24 hours.

### 3. Q:What should I do if my camera doesn't work?

1. Please open the camera back cover and rubber plug, find the 'RST' hole, insert a pin, and press it for more than 5s to reboot the camera.
2. Double-click the camera power button to reset the camera and add it again.

#### 4. Q:What if I did not receive motion detection notification?

- A.1. Go to 'Setting' page of your phone -> Notification -> Dzees Home App -> turn on 'Notification'.
2. Go to 'Home' page of App -> Setting -> Notification -> turn on 'Notification'.
3. Make sure to turn on the 'Motion Detection' function of the camera in App.
4. Reboot your internet router and make sure a strong Wi-Fi signal. Add your camera to your phone again in App.

#### 5. Q:How to turn on the alarm and flashlight?

- A.1. Go to 'Home' page and click 'Setting' on upper right corner of this page.
2. Click 'Audio Setting' to turn on 'Alarm Siren' and click 'Lighting Setting' to turn on 'Alarm Flash'.

#### 6. Q:How to turn on white light mode?

- A.1. Go to 'Home' page and click 'Setting' on upper right corner of this page.
2. Click 'Lighting Setting' and turn on 'Night Vision'.
3. Click 'Night Vision Mode', then choose 'White light mode'.

Note: 'White light mode' means that when the camera detects motion at night or view real-time live broadcast, the spotlight will stay on to get a colorful view.

#### 7. Q:How to find the serial number (SN) of the camera?

- A.1. Go to 'Home' page and click 'Setting' on upper right corner of this page.
2. View 'Camera Info' and click 'More info', you will see the SN number.

#### 8. Q:What is the longest time for the camera to record an alarm video?

- A.1. It records 3 minutes maximum under 'Auto' mode.
2. If you want each video to be 10s, 15s or 20s, you can set it in App.

### 9. Q:What if the SD card cannot be detected?

A,1. It must be a Micro SD card; at least 10 MB/S can be used (For a Micro SD card 64GB, 128G, 30 MB/S is recommended).

2. Insert the SD card to your camera when it is power on. You will hear 'SD card detected'. If no voice reminding, please turn off your camera and then insert the card again. Then turn on the camera and check the SD card status in App.
3. If it still cannot be detected, try formatting the SD card and reinsert.
4. Try to use another SD card and see if it works well.

### 10. Q:Why does the camera battery drain fast?

A,1. The longer the camera works, the faster the battery drains. Therefore, we suggest, if it's possible, reduce the sensitivity of motion detection, the time of two-way calls and watching live.

2. If you receive too many alarm notifications, please adjust the sensitivity from 'High' to 'Low' to reduce the number of alarms, or set the 'Activity Zone' to narrow the detection range.
3. You can adjust the installation angle of the camera to avoid unnecessary alarms, to save battery power. For example, don't let the camera face a sparkling swimming pool, swaying trees, or heavy traffic, etc.
4. As you may know, battery drains faster in cold enviroment.

**Please Email us for Better Solution  
instead of returning any unqualified product to Amazon**

[Support@Mubilife.net](mailto:Support@Mubilife.net)

**THANK YOU**



