

SPECIFICATIONS

Description	Professional Ultrasonic Cleaner	
Model	CD-4875	
Tank Capacity	7.5 L / 2.0 gallon (US)	Max. 6.0 L / 1.6 gallon (US)
		Min. 4.3 L / 1.1 gallon (US)
Tank Size	33.1x23.8x10.5 cm / 13.0"x9.4"x4.1"	
Longest Item Fits inside Tank	37.0 cm / 14.4"	
Power Supply	380W (AC 100~120V 60Hz)	
	410W (AC 220~240V 50Hz)	
	310W (AC 100V 50/60Hz)	
Digital Timer Settings	→10min →15min →20min → 25min →30min →5min	
Drainage	Drainage valve	
Ultrasonic Frequency	35,000 Hz	
Tank Material	Stainless Steel SUS304	
Housing Material	ABS	
Net Weight	9.8 kg / 21.8 lb	
Gross Weight	11.1 kg / 24.7 lb	
Unit Size	54.1x33.7x27.7 cm / 21.3"x13.3"x10.9"	
Inner Carton Size	60.0x38.0x33.5 cm / 23.6"x15.0"x13.2"	
Qty per Master Carton	1 pc / ctn	
Master Carton Size	62.5x41.0x37.0 cm / 24.6"x16.1"x14.6"	

PROFESSIONAL ULTRASONIC CLEANER

CD-4875

USER MANUAL

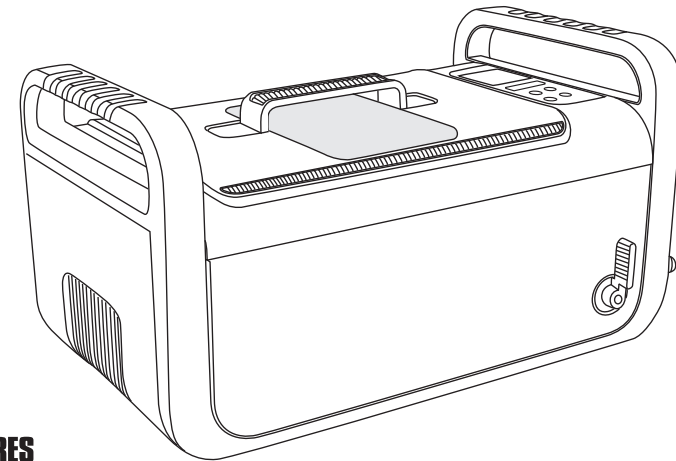

FEATURES

- 1 Large tank capacity** Tank capacity 7.5 L / 2.0 gallon;
Tank size 33.1x23.8x10.5 cm / 13.0"x9.4"x4.1"
- 2 Control panel with capacitive sensing technology** Durable, reliable, resistant to water and harsh chemicals
- 3 Drainage valve** Convenient to use
- 4 Three industrial grade ultrasonic transducers** Uniform distribution of ultrasonic waves, strong cleaning, high durability
- 5 Three ceramic heaters** Mounted underneath the bottom of the tank for safe and even heating; durable construction
- 6 3-color LED display** Easy to operate, with 4 key control panel, 6 timer settings, 3 temperature settings
- 7 Independent control circuit for each ultrasonic transducer** 40% higher efficiency, not susceptible to interference, more durable
- 8 Multiple circuit protectors** When overloaded or improperly used, the protectors shut down the power to certain areas to protect the machine
- 9 Moisture-proofed PCB with industrial IC** PCBs are placed vertically for better moisture-proof performance. Better anti-interference
- 10 Three cooling fans** Two for cooling of PCB boards, one for cooling of ultrasonic transducers. Improve heat dissipation and beneficial for continuous operations
- 11 Multiple optional accessories** Suspensible plastic basket, stainless steel rack and tray, indirect cleaning tank, beaker and double beaker holder
- 12 Solid and advanced structural design** 4.5 mm thick wall housing made from engineering grade plastic with tongue in groove design for better water-proof and drop-proof performances. 60% quieter than steel housing designs, suitable for indoor uses

INTRODUCTION

Use tap water. Special solutions are not necessary in most cases.

Principles of ultrasonic cleaning:
Millions of tiny air bubbles are generated within liquid by high frequency vibration. The air bubbles burst when in contact with object and dislodge the debris to achieve the cleaning effect.



- Using tap water is sufficient. Purified water or distilled water has the same cleaning effect as regular tap water for ultrasonic cleaning.
- When cleaning silver or copper items where oxidation has darkened the items, special solutions needs to be added to the water to remove the oxidation.

Main Features

- Tank opening 33.1x23.8x10.5 cm / 13.0"x9.4"x4.1". Longest item that can fit inside the tank is 37.0 cm / 14.6". 7.5 L / 2.0 gallon tank capacity.
- Multiple options for accessories, suitable for various applications.
- 3 industrial grade ultrasonic transducers: 3x(55~60)W=(165~180)W, 3 ceramic heaters: 3x(75~80)W=(225~240)W.
- 3-color LED display, 4-key controls, 6 timer settings, 3 temperature settings, simple and straightforward to operate.
- Control panel with capacitive sensing technology, Durable , reliable, resistant to water and harsh chemicals
- Electrical circuit features:
 - Three transducers, each has an independent PCB control. The output power is increased by 40% compared to less expensive control method that uses one PCB to control multiple transducers.
 - Multiple circuit protectors:
 - Thermal switch to prevent running dry. If temperature is too high, the switch cuts off power for approximately 6 minuts then reconnect the power.
 - Thermal protector to prevent PCB from overheating due to overload.
 - Timer to prevent heater from running continuously.
- Industrial grade IC. Moisture-proofed PCB. Cooling fan.
- Drainage valve.

Read the Manual First

The manual should be carefully reviewed before starting to use the device. Warnings should be observed carefully. Please follow the manual for operations.

TABLE OF CONTENTS

Safety Precautions -----	1,2
Items Not Suitable for Ultrasonic Cleaning -----	2
Applications -----	3,4,5
Sample Applications -----	5,6
Product Structure and Accessories -----	7
Product Exploded View-----	8,9
Control Panel and Operations -----	10,11
Common Cleaning Methods -----	11,12,13
Operation Guidelines -----	14,15
Care and Maintenance -----	16
Optional Accessories-----	17

OPTIONAL ACCESSORIES

Suspendible plastic basket

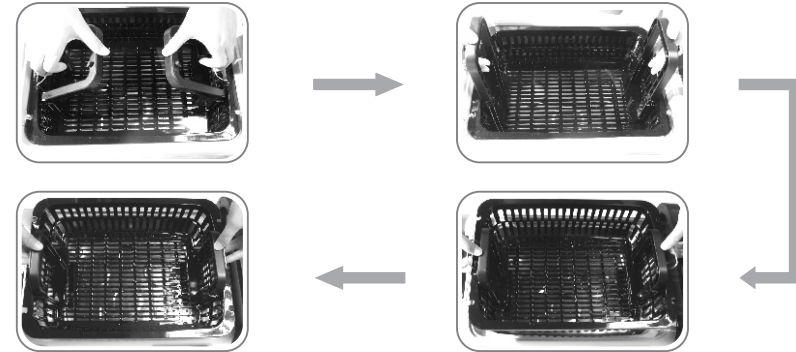

The basket has foldable handles. It can be raised and suspended above water to drain water.

Stainless steel rack and tray

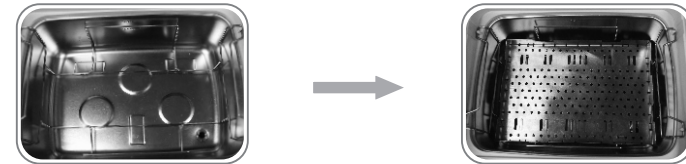

The rack can be used to support cassettes. 2 layers of cassettes can be used on top of each other. The tray can be used in place of the cassette. The tray is stackable so multiple layers of trays can be used.

Indirect cleaning tank



Place the indirect cleaning tank across the top of the main cleaning tank as shown. Add water inside the main tank so the water level reaches the indirect cleaning tank. Add solution to the indirect cleaning tank and clean the items inside. Cleaning efficiency can reach 90% inside the Indirect Cleaning Tank due to our technology and quality. It can be used to isolate the cleaning and the solution from the main cleaning action. It also reduces the amount of the solution needed.

Beaker and beaker holder

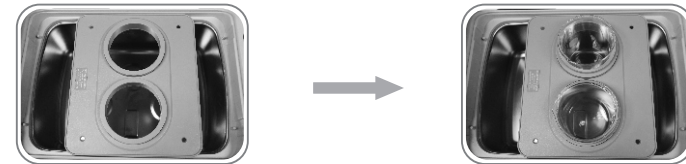

Place the beaker holder with beaker(s) across the top of the main cleaning tank as shown. Add water to the main tank so the water level reaches the beaker(s). Add solution inside the beaker(s). It can be used to clean small items such as dental burs and files, nozzles, etc.

CARE AND MAINTENANCE

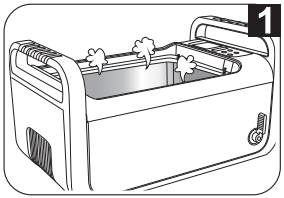

1 Do not turn on the unit without water in the tank.

Even though the unit is designed with multiple protections, if it is turned on for over 30 seconds without water in the tank, it may damage the unit or severely reduce the life of the unit.

⚠️ A thermal switch is attached to the bottom of the cleaning tank. If the unit is turned on accidentally without water in the tank, the ultrasonic energy will not be transferred out through the liquid and instead will be concentrated on the tank, the temperature of the tank will continue to rise. If the heater is turned on at the same time, the temperature of the tank will rise rapidly. This will trigger the thermal switch to cut off power to stop the ultrasonic transducer and the heater from running, hence to prevent damages to the unit and fire hazard. The switch cuts off power for approximately 6-10 minutes then reconnect the power automatically.

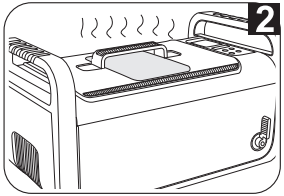

2 Do not run the unit for extended time or continuously.

The unit is designed with overheat protection. If the unit has been running for 45 minutes, it is recommended to stop the unit for about 20 minutes to prolong the life of the unit.

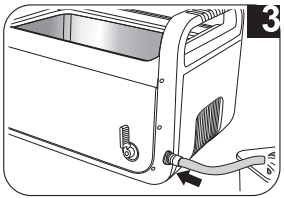

3 Do not keep water in the cleaning tank for a long time.

After cleaning is completed, open the drainage valve to drain the dirty water. Clean and wipe the tank dry.

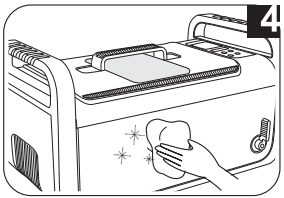

4 Do not spray water over the housing.

Use a towel to wipe the tank and the housing dry.

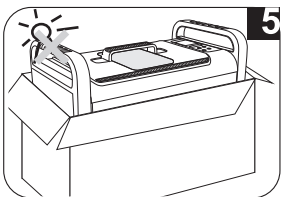

5 Do not expose the unit under direct sunshine for a long time.

Keep the unit in a dry, cool and ventilated area.

SAFETY PRECAUTIONS



Keep it away from children!

- **⚠️** This appliance can be used by children aged from 8 years and above if they have been given supervision or instruction concerning use of the appliance in a safe way and if they understand the hazards involved. Cleaning and user maintenance shall not be made by children unless they are aged from 8 years and above and supervised. **Keep the appliance and its cord out of reach of children aged less than 8 years.**
- Please store the ultrasonic cleaner where it is not reachable by children.
- Danger to children! Danger for death through suffocation! Keep the packaging material away from children.
- This appliance shall not be used by children. Keep the appliance and its cord out of reach of children.



To prevent life-threatening electrical shock, please observe the following:



⚠️ Danger of electrical shock! Do not use while bathing. Never immerse the device or the power cord in water or other liquid.

- **Danger of electrical shock!** Never touch the power plug with wet hands, especially when inserting or removing the plug.
- **Danger of electrical shock!** If the unit has fallen into water during operation, do not touch the unit. Remove the power plug from the socket first.
- **Danger of electrical shock!** Do not spray water or liquid over the device.
- Never operate the device unattended.
- Follow the manual to operate the device.
- Do not use components unapproved by the manufacturer.
- When removing the power cord from the socket, grab the power plug not the cord.
- To protect the power cord from damage, do not cause it to get caught by things such as a cupboard door or a chair leg; do not drag across a hot surface.
- If there is damage to the power plug, cord, housing, or other parts of the device, do not use the device.
- Do not disassemble the device, except by professionals.
- If the unit is damaged, non-operational or has fallen into water, take it to a qualified service provider.
- Remove the power plug from the socket
 - if malfunction occurs
 - before cleaning the device
 - if the device is not going to be used for prolonged period
 - after each use (recommended)
- The installation of an earth leakage circuit breaker with a rated tripping current of no more than 30 mA provides further protection against an electrical shock. The installation should only be carried out by a trained electrician.



To prevent fire hazards, please observe the following:

- Never block the vents on the device. Keep the vents free from lint, hair and other materials.
- Do not place the device on a soft surface, such as a bed or a couch, where the vents could be blocked.
- Observe the other warnings in the previous section.
- If the supply cord is damaged, it must be replaced by the manufacturer or its service agent or a similarly qualified person in order to avoid a hazard.

SAFETY PRECAUTIONS

⚠ Other observations:

- Do not operate the product without filling the tank with water. Running dry will damage the unit.
- Do not plug in the power cord before adding water to the tank. Do not fill the tank above the Max line to avoid overspill.
- Do not use solution containing abrasive substances or strong corrosive chemical solution not recommended by the manufacturer or the supplier.
- Place the device on a dry and flat surface for operation.
- When the device is subjected to severe electromagnetic interference, it may malfunction, stop operating or lose control functions. If this happens, unplug the power cord then reinsert it to restart the device.

IMPORTANT SAFETY INSTRUCTIONS



⚠ When using electric appliances, basic precautions should always be followed, including the following :

- Read all the instructions before using the appliance.
- To reduce the risk of injury, close supervision is necessary when an appliance is used near children.
- Only use attachments recommended or sold by the manufacturer.
- Do not use outdoors.
- To disconnect, turn all controls to the off (O) position, then remove plug from outlet. Do not unplug by pulling on cord. To unplug, grasp the plug, not the cord. Unplug from outlet when not in use and before servicing or cleaning.
- To reduce the risk of electrical shock, do not put the appliance in water or other liquid. Do not place or store appliance where it can fall or be pulled into a tub or sink.
- All servicing of this product, including transducer replacement, is to be conducted by qualified service personnel.
- Do not operate any appliance with a damaged cord or plug, or after the appliance malfunctions or is dropped or damaged in any manner. Return appliance to the nearest authorized service facility for examination, repair, or electrical or mechanical adjustment.

⚠ Items Not Suitable for Ultrasonic Cleaning

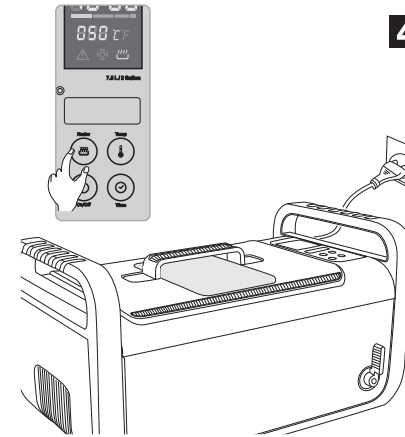
Soft Jewelry: Pearls, emerald, ivory, coral, agate, sea turtle shells, etc	These items are not hard, so scratches may occur during cleaning.
Welded, Plated and Glued Items: Welded or plated metal items, glued items	Ultrasonic cleaning may enlarge the gaps inside the welded joints, plated coating or glued items and may cause separation.
Watches: Except diver's watches with depth rating over 50 m (150 ft) .	Because the strong penetration capability of the ultrasonic waves, water may get into the watches if they are not truly waterproof. Use the watch stand supplied as a precaution if not sure.
Others: Wood; coated glass, ceramic, camera filters with preexisting cracks.	Ultrasonic cleaning may enlarge the cracks pre-existed in the coating on the glasses, ceramic, and glass. If the items have no pre-existing cracks, then it is okay.



- 4** Select one of the four cleaning methods recommended earlier.
- When the heater is needed, press TEMP button to select one of the 3 preset temperatures. Press Heater button,  flashes, indicating the heater is turned on. When the water reaches the set temperature,  dims, indicating the heater is turned off.

To ensure safety, the unit is designed with dual protections. The heater will be turned off automatically if it has been running for 50 minutes.

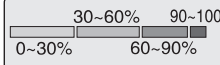
 Thermometer lights up to indicate the percentage of the set temperature reached.

- When debris "smoke" is no longer visible, cleaning is done. If additional cleaning is needed, reset the timer and repeat the steps above.

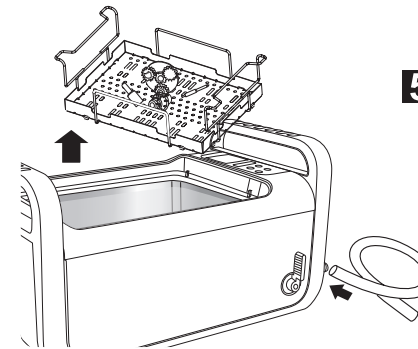

- 5** When cleaning is completed, switch off the power, open the lid and retrieve the basket and the items. Alternatively, raise and suspend the basket above water as illustrated in the Optional Accessories section to drain water.
- Connect the hose to the drainage pipe as shown. Open the drainage valve to drain the dirty water. Clean and wipe the tank dry. Close the drainage valve.

OPERATION GUIDELINES

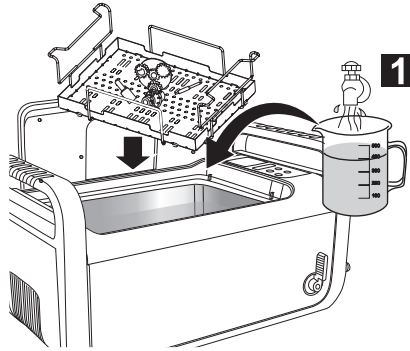

- 1 Remove the cover and put it on the cover holder vertically. Put items in the basket then put them in the cleaning tank. Add water to a level between MIN and MAX and above the area to be cleaned.

 If the unit is turned on without water, ultrasonic energy will not be absorbed. This model also has high power. Once on for over 15 seconds, it may damage the unit or severely reduce the life of the unit.

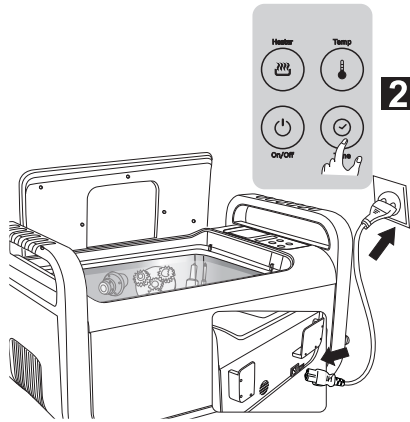

- 2 Connect the power cord to an outlet and turn the switch on. LED display shows 10:00. This is the most common timer setting.

If the timer needs to be adjusted, press Time button.

Select desired time setting by pressing Time button:
 →10min → 15min → 20min → 25min → 30min → 5min



Prolonged cleaning time may result in:
 a. Loosening of the screws if used.
 b. If items are plated and have existing cracks, the cracks may become more pronounced.
 c. Coating with preexisting damages may experience more peeling.

- 3 Press On/Off button to start cleaning.

During cleaning, buzzing sound can be heard from the cleaning tank, indicating that the cleaning is underway. Closing the lid will reduce the noise level.

The digital timer will count down to show the remaining cleaning time. When it displays 00:00, the cleaning is done.

To stop cleaning at any time, press On/Off button.

The unit is equipped with overheat protector. If the unit has been running for too long, the red warning light “” will illuminate, indicating the unit is under overheat protection. The unit can not be operated until idling for about 15 to 20 minutes. The “” turns off and the operation can be resumed.

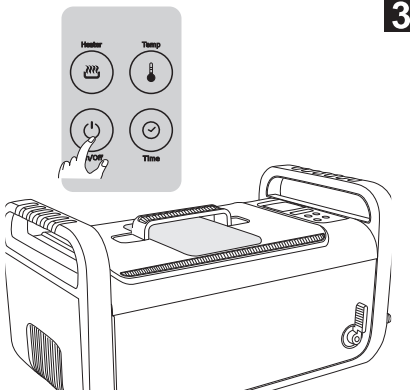

APPLICATIONS



1. **Metal Processing Manufacturers and Jewelry Makers**
 - Ultrasonic cleaning can remove grease or abrasive powder from work-in-process metal items and keep them clean.
 - Jewelry made with investment casting often has wax layer in addition to debris. Turning on the heater will raise the water temperature, melt the wax and improve the cleaning.



2. **Optical Labs**
 During edging and polishing, debris and abrasives can scratch lenses. Ultrasonic cleaning can effectively protect the lenses. Debris exists in the crevices of the frames during processing and polishing. Using ultrasonic cleaner and tap water can easily remove the debris



3. **Biology, Chemical Laboratories:**
 Labs can use ultrasonic cleaners to clean test tubes and other glass or metal containers to remove residual chemicals and debris that can affect the accuracy of the test results.



4. **Medical Instrument Disinfection Rooms:**
 Non-disposable medical instruments may have blood or organic tissues left after use. They need to be removed with ultrasonic cleaners before disinfection.



5. **Dental Clinics:**
 Dental clinics can use ultrasonic cleaners to clean dental instruments and to remove blood and small particles left on the instruments before disinfection.

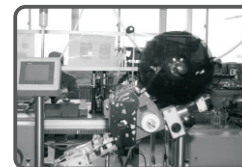

6. **Electrical Component Manufacturers**
 Terminals on AC contactors and relays need to be kept clean to prevent sparking and non-contact. Ultrasonic cleaning is the most effective method to keep these parts cleaning.

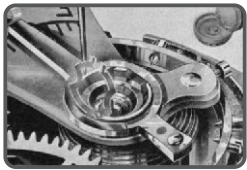

7. Watch and Precision Metal Part Manufacturers

Machined watch components and other precision metal parts often have coolant and debris left on the surfaces. Ultrasonic cleaning can remove the debris and keep the parts clean.



8. Shooting Clubs

To reuse brass cartridges: Adding special solution can make fired brass useable and like new again. Gun cleaning and care: Cleaning guns after shooting is time consuming. Using special solution in the water and using ultrasonic cleaners can complete the cleaning better, quicker and easier than traditional methods.



9. Special Education Institutes / Kindergartens

Speech therapy tools or small toys that are reused need to be cleaned to prevent the growth and spread of bacteria. Ultrasonic cleaning can perform thorough cleaning by removing debris hidden inside small holes and crevices before disinfection.



10. Golf Clubs:

Cleaning the heads of golf clubs is a time consuming job. Using ultrasonic cleaning with the Enhanced Cleaning method can improve the effectiveness and efficiency.



11. Mobile Phone and Electronics Service Shops

PCB renewal: Non-operational electronics, after falling into water, or non-operational key pads can be cleaned with ultrasonic cleaners and pure alcohol to recover the functions. Use the Indirect Cleaning method for small-sized PCBs.



12. Homes

Silverware, silver, copper or brass decorations: It's difficult to clean debris hidden in the patterns with regular methods. Ultrasonic cleaning with 50 ml (3 tablespoons) of dish soap will clean the debris quickly.

For silver, copper or brass items with oxidation which has darkened the items, adding small amount of special solution

that can remove oxidation and using ultrasonic cleaning will restore the shine.

Children or baby items: Debris left in the small holes and crevices are difficult to clean. Bacteria and molds can grow. Using ultrasonic cleaning to deep clean the items before disinfection.

Warm water and dishwashing liquid can soften grease and improve cleaning efficiency.

5. Press Time button to set the timer to 15 minutes. Press On/Off button to start cleaning. Grease will dissipate and appear to be like black smoke in the water.
6. When it stops, open the drainage valve to release the dirty water. Close the valve afterwards.
7. Clean the tank and add fresh water. Wash the items for another 3 minutes to remove the residual debris and the detergent.

SPECIAL CLEANING



Silver, copper or brass items with oxidation which has darkened the items will need special cleaning.

Suitable Locations: silver, copper or brass product manufacturers, home, shooting clubs.

Cleaning Method: 1. Put the items in the basket and then in the tank, add water to a level between MIN and MAX and above the area to be cleaned. 2. Add special solution that can remove silver or copper oxidation according to the ratio recommended (typically 1:10), Use special solutions according to the instructions for brass cartridges.

3. Turn the power switch on. Press Temp button to set the water temperature to 50°C (122°F). Press Heater button to turn on the heater, flashes.

Close the lid. LED lights up indicating the percentage range of the set temperature being reached. When water reaches the set temperature, dims, indicating the heater is turned off.

The heater has dual protection. It will be turned off automatically after 50 minutes.

4. Press Time button to set the timer to 15 minutes.
5. When it is done, remove the basket and the items. Rinse the items with tap water or follow steps 6 and 7 in the **Enhanced Cleaning** section.

During cleaning, debris will come off the items like "smoke". Water will become murky. This method will remove silver or copper oxidation and debris in the decorating patterns and crevices and make the items like new again.

INDIRECT CLEANING

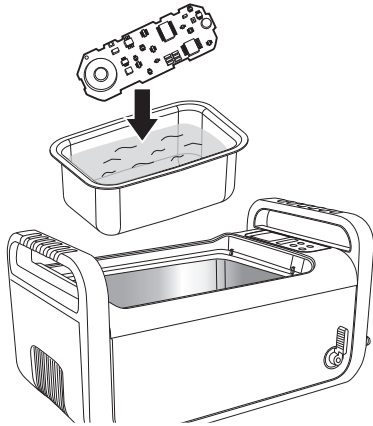

6. Homes - Rubbing alcohol (to remove odor, to clean and to disinfect at the same time)

Avoid acetone from contacting the plastic housing to prevent corrosion. Use Indirect Cleaning and a glass or metal container for acetone.

Cleaning Method:

1. Put the item inside a container. Add proper fluid to submerge the area to be cleaned.
2. Place the container in the tank directly. Add water to a level between MIN and MAX, not over the container.
3. Turn the power switch on. Press Time button to set the timer to 10 minutes. Press On/Off button to start cleaning. Ultrasonic waves will penetrate the container and clean the items.

Selection of container:

1. Plastic containers – Plastics are soft and will absorb about 30-40% of ultrasound energy and reduce the cleaning effect.
2. Aluminum containers – Absorbs about 20% of ultrasonic energy.
3. Glass containers – Absorbs about 15% of ultrasonic energy.
4. Stainless steel containers – Absorbs about 8% of ultrasonic energy.

Put the items in a separate container. Use ultrasonic waves to penetrate the container to do the cleaning.

Suitable Locations: medical instrument sterilization rooms, precision electrical parts manufacturers, watch and precision parts manufacturers, mobile phone and electronics service shops, large printing shops.

Different industries use different fluids to be used inside the container:

1. Watch service shops - Watch oil (to prevent rust)
2. Medical instrument sterilization – Enzymatic solution (cleaning prior to sterilization)
3. Precision electrical parts – Hexane (to dissolve grease, to evaporate quickly)
4. Mobile phone and electronic service shops - Pure alcohol (to evaporate quickly)
5. Printing shops – Acetone are often used (to dissolve ink)

ENHANCED CLEANING

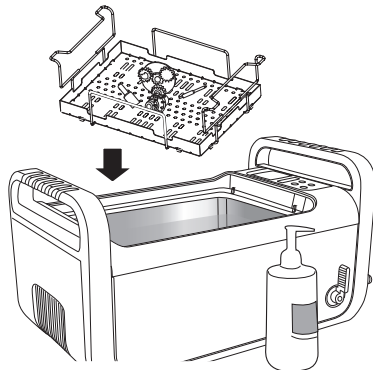

Debris accumulated over a long period of time, greasy or heavily soiled.

Suitable Locations: metal processing and jewelry makers, hardware manufacturers, shooting clubs, homes, golf clubs, automotive repair shops.

Cleaning Method:

1. Large items can be put in the tank directly. Small items can be put in the basket then put in the tank. Do not put the items on top of each other to avoid rubbing during cleaning.
2. Add water to a level between MIN and MAX and above the area to be cleaned.
3. Add 50 ml (3 tablespoons) of dishwashing liquid.
4. Turn the power switch on. Press Temp button to set the water temperature to 55°C (131°F). Press Heater button to turn on the heater, flashes. Close the lid. LED lights up. When water reaches the set temperature, dims, indicating the heater is turned off.

Crystal glasses and decorations, chandeliers: Ultrasonic cleaning can bring back the sparkles and make them look like new again.

Jewelry, eyewear, watch bands, shavers or razors: Ultrasonic cleaning can clean the debris in the crevices. It is quick and convenient.

This model has a large tank. When cleaning small items, the Indirect Cleaning method can be used with satisfactory results. Smaller ultrasonic cleaners can also do the job.

13. Printing Shops

Unblocking dried printer heads or ink cartridges: Large printers and inkjet printers often have dried printer heads or ink cartridges ports. Replacing them with new ones is very costly. Adding acetone or special cleaning solution and using an ultrasonic cleaner with a couple of minutes of cleaning will remove the blockage and make them usable again.



Avoid acetone from contacting the plastic housing to prevent corrosion. Use Indirect Cleaning explained later and a glass or metal container for acetone.

14. Automotive Repair Shops



The Enhanced Cleaning method can be used to clean precision parts such as valves, injectors, gears and bearings. It cleans out debris in tiny holes and crevices effectively.



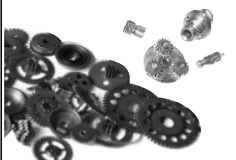

SAMPLE APPLICATIONS

JEWELRY	PERSONAL ITEMS	MEDICAL / DENTAL INSTRUMENTS
Necklaces, rings, earrings, bracelets, etc.	Eyeglasses, sunglasses, shaver heads, watch bands, diver's watches, dentures, etc.	Surgical instruments, pliers, handpieces, etc.

SAMPLE APPLICATIONS

PRECISION PARTS	SILVERWARE, SILVER, COPPER OR BRASS DECORATIONS	CHILDREN AND BABY ITEMS
		
Bearings, gears, valves, tools, fuel injectors, etc.	Silverware, silver, copper or brass decorations, etc.	Toys, baby items, speech therapy tools, etc.

LAB ITEMS	BRASS, GUN PARTS	PCB, INKJET CARTRIDGES
		
Test tubes, beakers, flasks, etc.	Reusable brass, gun parts, etc.	PCBs from mobile phones and MP4, ink cartridges, etc.

GOLF CLUBS	ELECTRICAL PARTS	LENSES, CRYSTALS
		
Golf clubs and golf balls	Terminals for relays and contactors	Lenses, crystals

9. **Temperature Set Button.** 3 set temperatures (°C/°F) can be selected. Press Temp button to select the temperature in the following sequence:

[>50°C → 55°C → 60°C] [→122°F → 131°F → 140°F]

10. **On/Off Button.** After powering on, the LED displays 10:00 which is the default time (as shown), and the unit is ready with the normal working status. Press On/Off key twice once and the cleaning starts. The cleaning stops when the timer counts down to 00:00. If the unit needs to be stopped before the timer runs out, press On/Off key twice.



⚠ To prevent accidentally turning on or off the unit, the On/Off key needs to be touched twice within 6 seconds to turn it on or off. 🌀 flashes, indicating the unit is running under Normal Cleaning mode.

11. **Timer Quick Set Button.** Press Time button, LED display shows 10:00. Each pressing increases the time by 5 minutes.

COMMON CLEANING METHODS

REGULAR CLEANING



Only tap water is needed.

Suitable Locations:

Jewelry makers, optical labs, biology / chemical labs, homes, speech therapy clinics, kindergartens.

Cleaning Method:

1. Put the items to be cleaned inside the basket and put the basket inside the tank.
2. Add water to the cleaning tank to a level between "MIN" and "MAX" lines and above the area to be cleaned.
3. Turn the power switch on. Press Time button to set the timer to 5 -10 minutes. Press On/Off button to start cleaning.

Notes on using the basket:

1. Basket can reduce the friction between the items and the tank. But stainless steel basket absorbs approximately 8% of ultrasonic energy, plastic basket absorbs about 35% of ultrasonic energy. This significantly reduces the cleaning effectiveness.
2. During cleaning, dirt will come off like smoke and the water will become murky over time. When "smoke" stops coming, the cleaning is basically done.

CONTROL PANEL AND OPERATIONS

- 10:00—Working Time Display.** It counts down after work is started.
- Multistage Thermometer.** Solid green light indicates that the water temperature is 0-30% of the set temperature. Solid orange light indicates that the water temperature is 30-60% of the set temperature. Solid red light indicates that the water temperature is 60-90% of the set temperature. Flashing red light indicates that the water temperature is close to the set temperature. All lights indicate that the water temperature is at the set temperature (90-100%).
- 050—Set Temperature Display.** Press Temp button to select one of the 3 set temperatures.
 $\rightarrow 50^{\circ}\text{C} \rightarrow 55^{\circ}\text{C} \rightarrow 60^{\circ}\text{C}$ $\rightarrow 122^{\circ}\text{F} \rightarrow 131^{\circ}\text{F} \rightarrow 140^{\circ}\text{F}$
- CF — °C or °F Indicator.**
 $^{\circ}\text{C}$ — Set temperature in °C.
 $^{\circ}\text{F}$ — Set temperature in °F.
- ⚠—Overheat protection warning light.** If the unit is working improperly or has been running for too long, the red warning light will illuminate, indicating the unit is under overheat protection. The unit can not be operated until idling for about 15 to 20 minutes. The warning light then turns off and the operation can be resumed.
- 🔥 — Heater Status.** Press Heater button, flashes, indicating the heater is turned on. Press Heater button again, dims, indicating the heater is turned off.
- 🌀 — Normal Cleaning Status.** — Illuminated, normal cleaning is underway.
- Heater button.** Pressing Heater key twice, flashes, indicating the heater is turned on. To cancel heating, press Heater key twice again, dims, indicating the heater is turned off.

To prevent accidentally turning on or off the heater, the Heater key needs to be touched twice within 6 seconds to turn it on or off flashes, indicating the heater is on.

When the water reaches the set temperature, the heater will turn off automatically.

The ceramic heater used in this unit has the advantages of having small size, high heat and longevity. To avoid damages to the heater, do not add cold water when the heater is hot otherwise ceramic may break due to large temperature differences.

Avoid the following misuses of the heater:

1. Drain dirty water out then add cold clean water when the heater is on.
 2. Turn on the heater when the tank is empty. Heater can be damaged if it is run for more than 15 seconds without water in the tank.
- Always turn off the heater before adding cold water. Make sure there is enough water in the tank before turning on the heater.

PRODUCT STRUCTURE AND ACCESSORIES

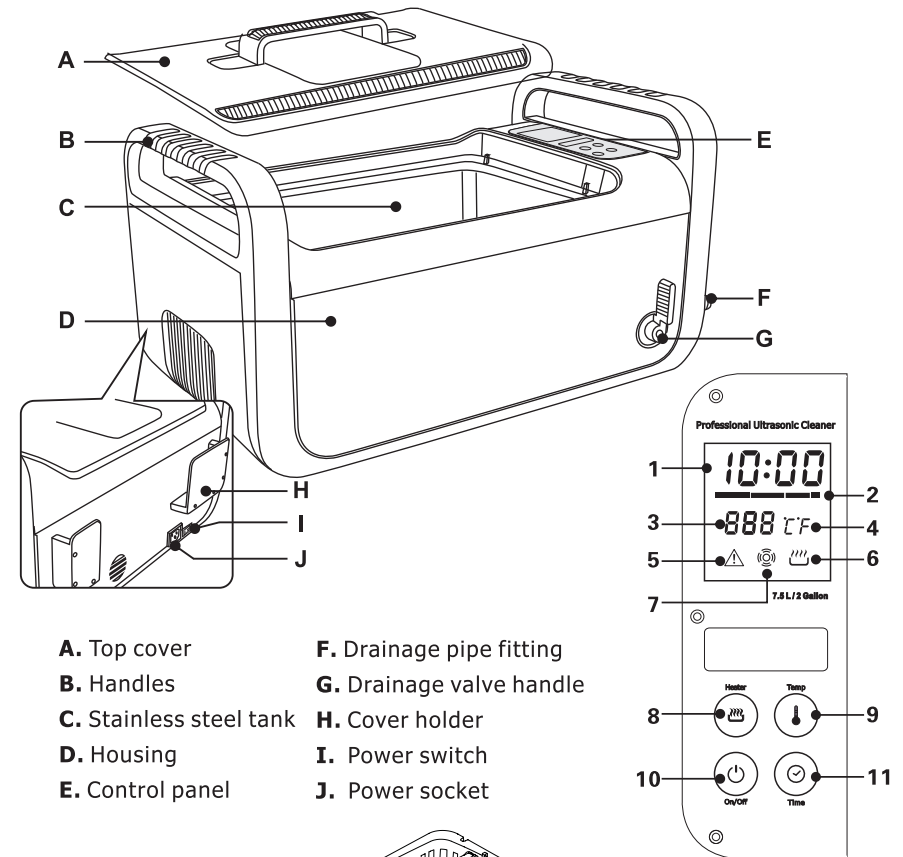

- | | |
|--------------------------------|---------------------------------|
| A. Top cover | F. Drainage pipe fitting |
| B. Handles | G. Drainage valve handle |
| C. Stainless steel tank | H. Cover holder |
| D. Housing | I. Power switch |
| E. Control panel | J. Power socket |

OPTIONAL ACCESSORIES:

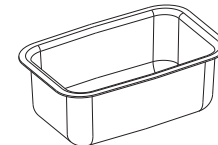

Indirect cleaning tank

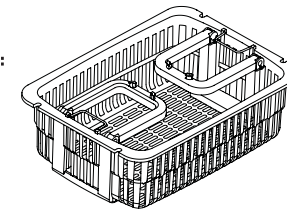

Suspendible plastic basket

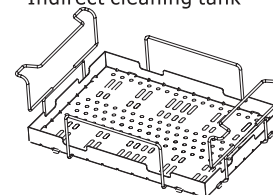

Stainless steel rack and tray

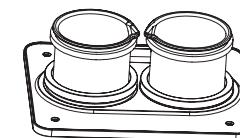

Beaker and beaker holder

STANDARD ACCESSORIES:



Power cord

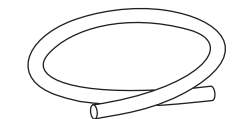

Hose

PRODUCT EXPLODED VIEW

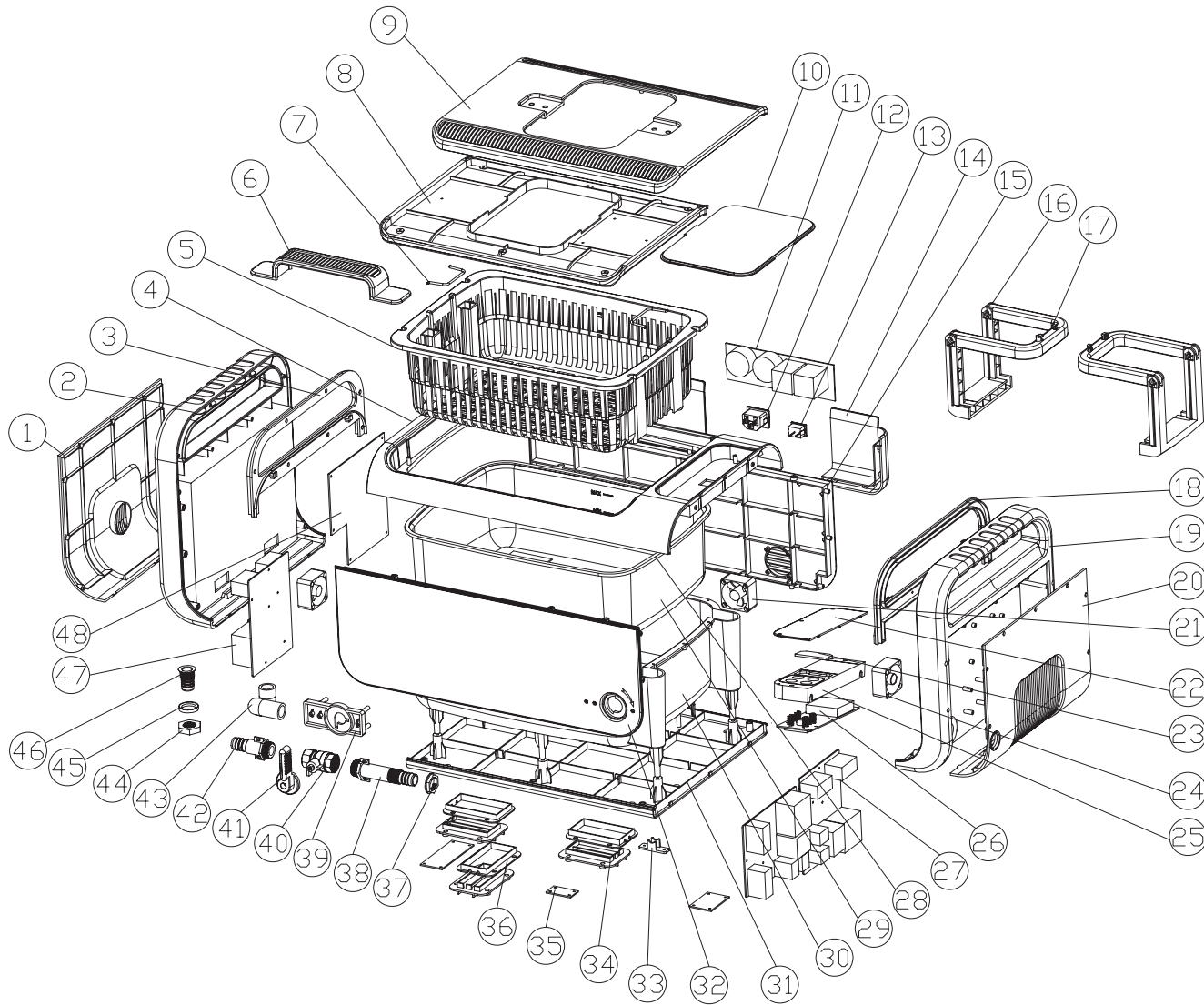

No.	Item	Material
①	Left cover	ABS
②	Left panel/handle	ABS
③	Left inside cover	ABS
④	Top ring	ABS
⑤	Plastic basket	ABS
⑥	Top handle	ABS
⑦	Stainless steel handle	SUS 304
⑧	Lid-bottom	ABS
⑨	Lid-top	ABS
⑩	Lid-window	AS
⑪	Power switch PCB	94V ₀
⑫	Power socket	Standard part
⑬	Power switch	Standard part
⑭	Lid holder	ABS
⑮	Back cover	ABS
⑯	Basket foldable handle 1	ABS
⑰	Basket foldable handle 2	ABS
⑱	Right inside cover	ABS
⑲	Right panel/handle	ABS
⑳	Right cover	ABS
㉑	Cooling fan	Standard part
㉒	Control panel cover	PMMA
㉓	Illumination window	AS
㉔	Cooling fan	Standard part
㉕	Control panel box	AS
㉖	LED	Fire retardant ABS
㉗	Control PCB	94V ₀
㉘	Silicon seal	Silicone rubber
㉙	Stainless steel tank	SUS 304
㉚	Inner tank	ABS
㉛	Bottom cover	ABS
㉜	Front cover	ABS
㉝	Thermocouple holder	ABS
㉞	Heater cover	PA 66
㉟	Insulation	94V ₀
㊱	Heater pocket	PA 66
㊲	Nut	ABS
㊳	Spout	ABS
㊴	Bracket	ABS
㊵	Ball valve	Standard part
㊶	Valve handle	ABS
㊷	Elbow	ABS
㊸	Hose	Silicone rubber
㊹	Nut	AL
㊺	Washer	AL
㊻	Spout	SUS 304
㊼	Transducer PCB	94V ₀
㊽	Power PCB	94V ₀