

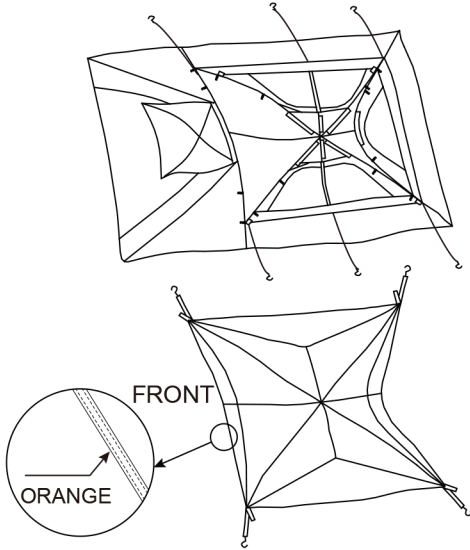







# Truck Tent

## Part List



- A BLUE { 
- B ORANGE 
- C BLACK 
- D WHITE { 
- E RED 
- F GREY 
- G STEEL POLES { 

## Installation

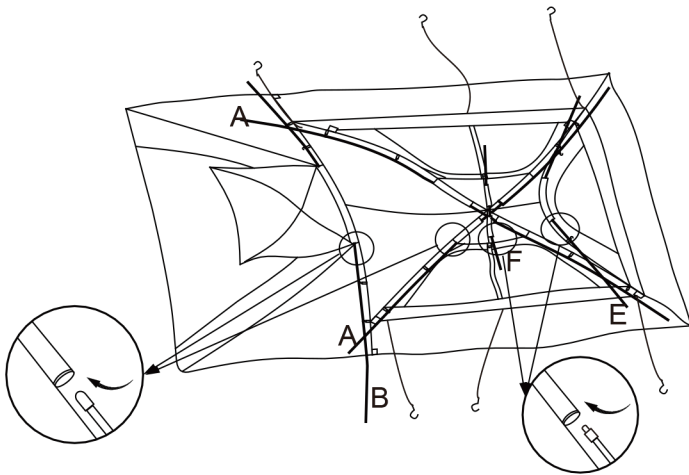

- Step 1: Take out your tent from its bag.
- Step 2: Insert each of Pole A (labeled blue) into the sleeves, forming the X over the roof.

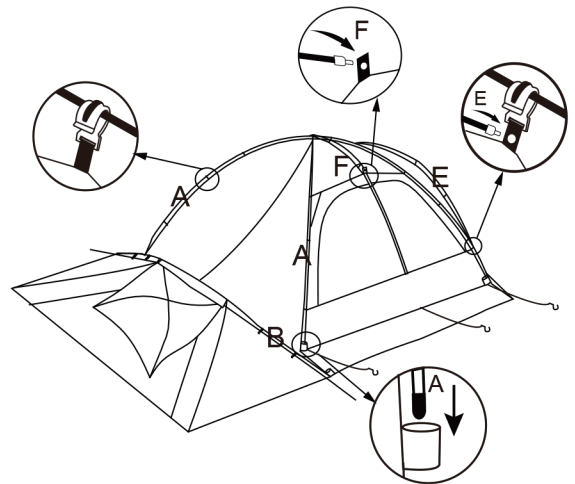

- Step 3: Insert Pole B (Labeled Orange) into the sleeves, forming the front door. Insert Pole E (Labeled Red ) into the sleeves, forming the back door. Insert Pole F (Labeled Grey) into the sleeves, forming the middle of the roof.