

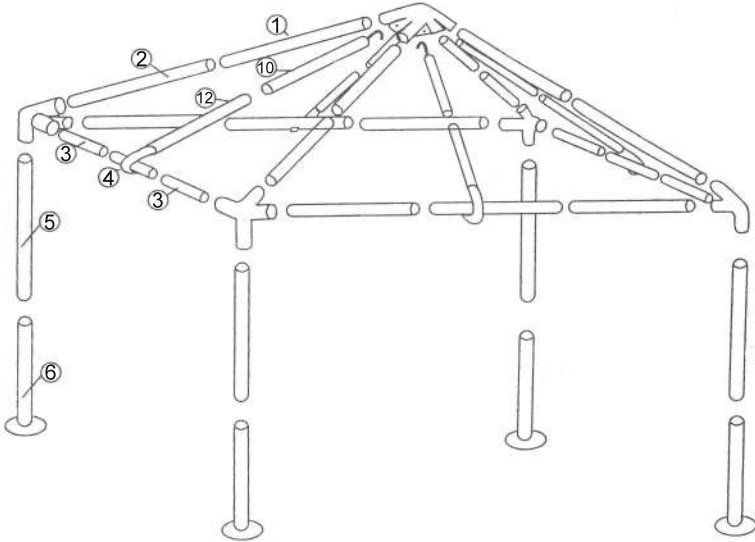









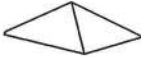



PACKAGE CONTENTS

For 10' x 10' Model - GM1201

The party tent is packed in one box. Please check the contents according to this list. If there's any part missing, contact us immediately to get replacement.



PART#	DESCRIPTION	QUANTITY	PART#	DESCRIPTION	QUANTITY
#1		4			
#2		4	COVER		1
#3		8			
#4		4	WINDOW SIDE		4
#5		4			
#6		4			
#10		4	ROPE		4
#12		4			
#13		1			
#14		4	PEG		8
#15		4			

INSTALLATION

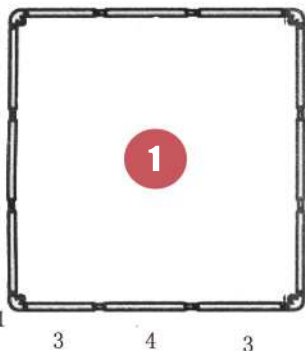

STEP 1

Assemble the upper frame using POLE #3, #4 & the Side Corner Joints #11.

STEP 2

Attach the roof section to the upper frame using Pole #1, #2, #10, #12 & the Centre Connector #13. Then place Pole #5 into the remaining outlet of the Side Corner Joints #11.

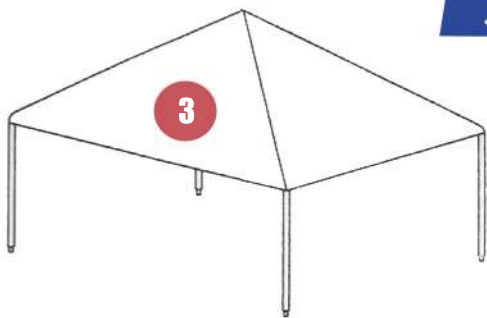
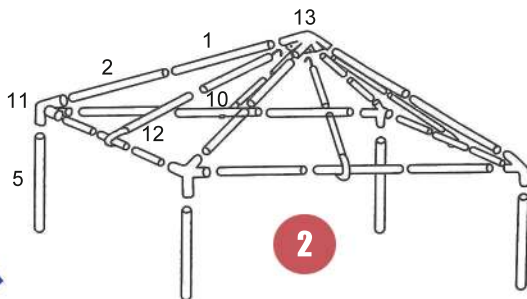

STEP 3

Place the cover tightly over the frame.

STEP 4

Slot the remaining legs (Pole #6) into position ensuring the Base Plates #15 are at the base.

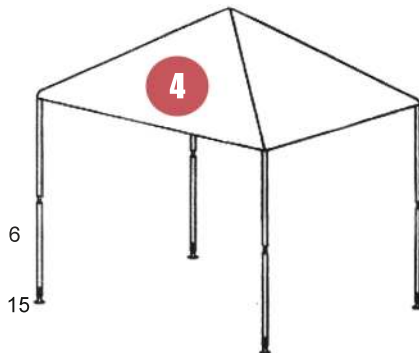

INSTALLATION

5

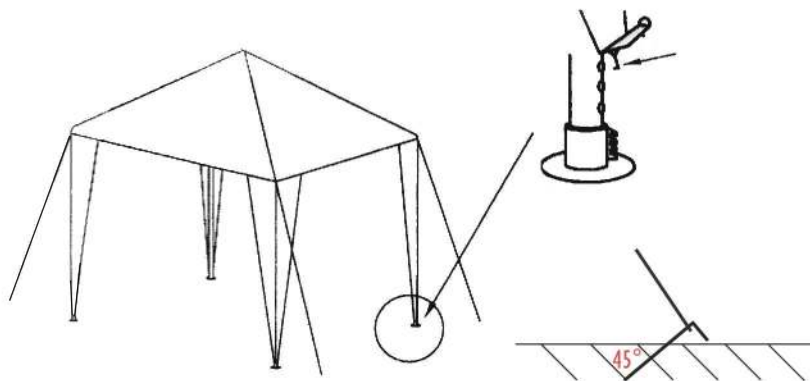

STEP 5

Pull the leg covers tight and attach the metal hooks into the tube holes near the feet. If the cover becomes loose, tighten by moving the hook to a lower hole. Then secure the tent with Ropes and the Stakes. We recommend the stakes are at a 45 degree angle into the ground facing away the tent to ensure maximum tension.

6

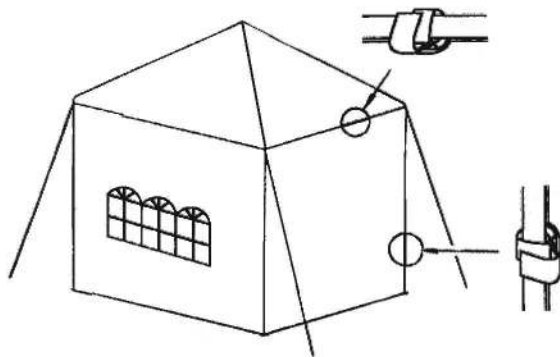

STEP 6

Hang the side panels to the Poles by Velcro Ties. All side panels can be hung or taken off separately.