



NSW-Z120904

User Manual



12" DUAL 4Ω SUBWOOFER

YOUR SUBWOOFER

Dear Customer,

Congratulations on purchasing our Nakamichi mobile system product for your sound system.

This product has been designed and manufactured to Nakamichi's exacting standards to ensure many years of audio enjoyment. For the best performance, we recommend that you have your Nakamichi product installed by an authorized Nakamichi dealer.

If you would like to install this product on your own, we recommend for you to go through this manual to familiarize yourself with all the installation requirements and procedures.

If you encounter any issues or if you have any questions on the operation of this product, please contact your nearest authorized Nakamichi dealer for assistance, or you may also contact us through our website or social media channels.

Installation of your Product

In today's modern vehicles, it is very easy to cause damage to existing systems through improper installation. Please follow and scrutinize all wiring diagrams to ensure that you have connected everything in its proper place.

If you find yourself uncomfortable or unfamiliar with understanding the wiring and installation diagrams or testing instructions, do contact your nearest Nakamichi dealer to perform the installation for you.

Safety Warnings and Considerations

- Clean only with a dry cloth or other similar materials.
- Install your product in a dry, well-ventilated location that does not interfere with your vehicle's safety equipment.
- Do not block any ventilation openings when installing this product.
- Do not mount the product in the engine compartment of your vehicle or in any areas of extreme heat such as mufflers, silencers, exhaust pipes or other heat producing apparatus.
- Securely mount the product so that it does not come loose in the event of a collision or as a result of repeated vibrations that might occur during normal operation.
- Installation of the apparatus must be done with great care to prevent damage to your vehicle's fuel lines, power, and other electrical wiring, hydraulic brake lines, and other systems. If possible, always visit your nearest Nakamichi dealer to perform the installation.
- Do not run any wiring outside or underneath the vehicle. Keep all wires inside the vehicle.
- Take the necessary precautions when making connections to the vehicle's battery to avoid any potential shock.
- Protect all system wires from sharp edges by carefully routing them, always use rubber grommets to protect wiring and cables whenever you are installing them through metal openings.

YOUR SUBWOOFER

- Secure all wiring using cable ties or wire clamps to protect them from moving parts and sharp edges.
- This apparatus shall not be exposed to dripping or splashing, and no object filled with liquids, shall be placed on the apparatus.
- Refer all servicing to qualified service personnel. Servicing is required when the apparatus has been damaged in any way, such as the power input terminals are damaged, liquid has been spilled or objects have fallen into the apparatus, the apparatus has been exposed to rain or moisture, does not operate normally, or has been dropped.
- Fuses shall be replaced only with the correct type and fuse value, and only when the apparatus is powered off.
- Exposure to high sound pressure levels may lead to permanent hearing loss. Take every precaution to protect your hearing.
- This product is designed specifically for use with 12 volt, negative- ground electrical systems only. Using this product in systems with positive ground and/or voltages other than 12V may result in damage to the product and your system.

COMMON FAULTS & SOLUTIONS

Issues	Causes	Solutions
Can't switch on the unit.	1.No +12V on the remote. 2.Ground not properly connected.	1.Supply the terminal in +12V. 2.Connect the supply in +12V. 3.Check connections to ground. 4.Change fuse.
No sound.	1.Broken line. 2.No correct connection.	1.Check the cable. 2.Check the power of the 3.Connecting cable.
Distorted output.	1.Source level too high. 2.Gain of the amplifier too high.	1.Turn down the source level. 2.Turn down the gain of the amplifier.

ACCESSORY LIST

Check and identify the contents of your package:

1. Subwoofer x 1pc
2. User manual x 1pc
3. Ø5×30mm Screw x 8pcs
4. Mounting template x 1pc

SPECIFICATIONS & DIMENSIONS

Model No.:	NSW-Z1209D4
Nominal Diameter:	12" (305mm)
Mounting Depth:	6" (152mm)
N-Power:	900 watts
Peak Power:	6000 watts
Nominal Impedance:	4 Ω +4 Ω
Frequency Response:	40Hz-500Hz
Sensitivity (SPL/1W/1m):	86 \pm 3dB
Free Air Resonance (Fo):	40.694Hz
Suspension Compliance (Cms):	76.611 μ M/N
Moving Mass (Mms):	199.662g
Mechanical "Q" (Qms):	3.512
Electrical "Q" (Qes):	0.840
Total Speaker "Q" (Qts):	0.678
Equivalent Volume (Vas):	28.373Ltr
DC Resistance (Re):	3.4 Ω +3.4 Ω
Effective Piston Area (Sd):	51.093mm ²
Force Factor (BL):	10.164Txm
Reference Efficiency (No):	0.220%
Voice Coil (V.C.):	Φ 75.5mm, BASV
Magnet Mass:	118.5oz (3359g)
Subwoofer Mass (1pc):	Approx. 8.6kg

Unit: mm

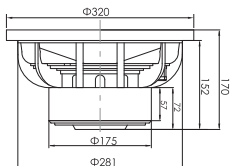
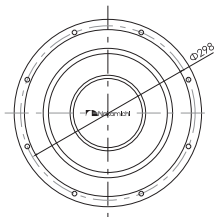

INSTALLATION

Option 1: Mount on Rear Tray

You can mount the subwoofer on the rear tray.

- Set the wiring firmly on the floor of the vehicle, taking the utmost care not to break wires while installing.

1. Turn off the car ignition key.
 - If the power is on, the click noise generated by the connection may damage the subwoofer.
2. Cut out the mounting template from the packing box and paste it onto the location selected for mounting the subwoofer.
3. Mark the cut-off hole and the 8 bolt holes.

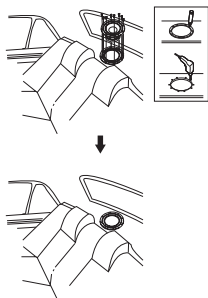

INSTALLATION

- Cut out the marked area and drill the bolt holes.
- Connect the subwoofer to the amplifier.

- The impedance of the units are related with how to connect. Make sure that the output impedance of the amplifier's speaker terminal is relevant with connection.
(Refer to "Wire Connection".)

- Consult the diagram. Be sure to connect corresponding terminals, i.e. "+" to "+" and "-" to "-". Connection with reversed polarity will degrade the quality of reproduction.

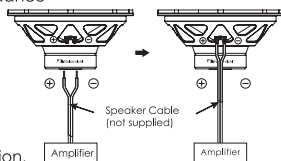

- Mount the subwoofer into the rear tray with the supplied screws.

Option 2: Install in A Sealed Enclosure

If the subwoofer cannot be mounted on the car, place it in a sealed enclosure. Recommended enclosures have been designed and thoroughly tested.

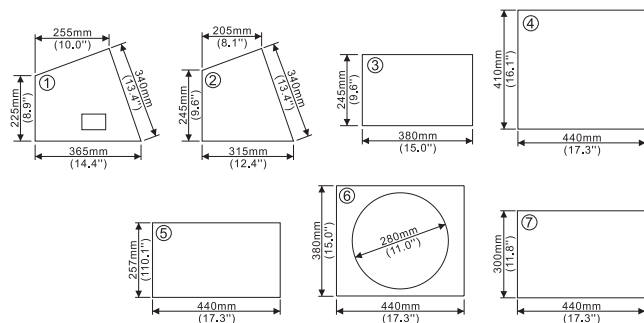
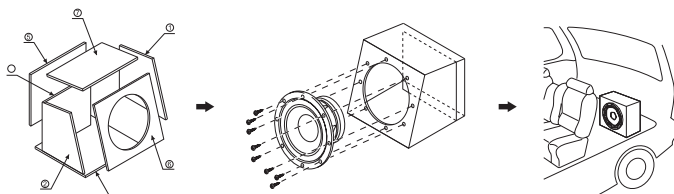

All boards thickness: 18mm

Connect the subwoofer to the amplifier.

Install the subwoofer into the sealed enclosure with the supplied screws.

WIRE CONNECTION

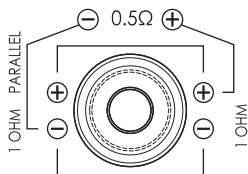

1PC SUBWOOFER DUAL 1 OHM

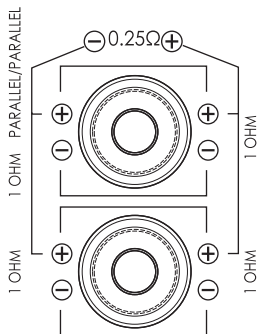
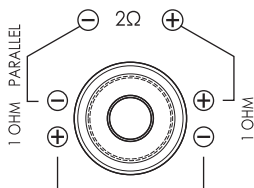

2PCS SUBWOOFER DUAL 1 OHM

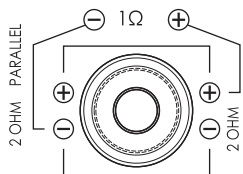
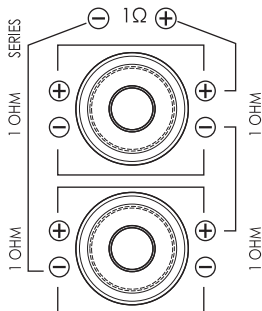

1PC SUBWOOFER DUAL 2 OHM

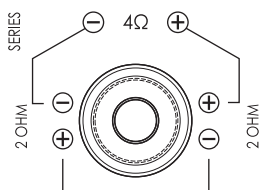

WIRE CONNECTION

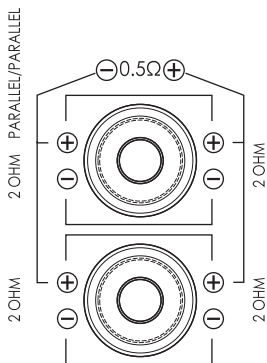

2PCS SUBWOOFER DUAL 2 OHM

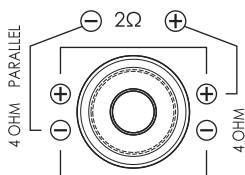
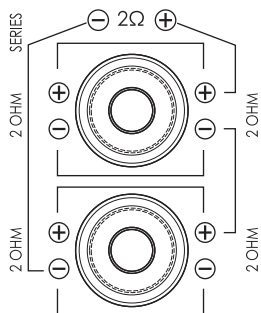

1PC SUBWOOFER DUAL 4 OHM

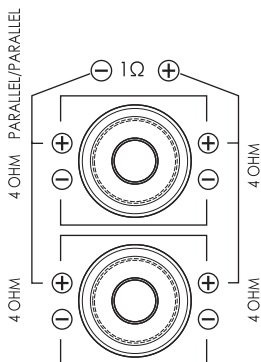
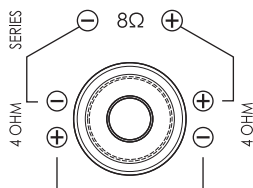

2PCS SUBWOOFER DUAL 4 OHM

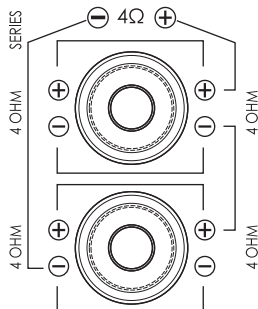



SCAN OUR QR CODE OR VISIT WWW.NAKAMICHICARAUDIO.COM
FOR COMPLETE AUDIO SETTINGS INSTRUCTIONS

 [nakamichi.global](https://www.facebook.com/nakamichi.global)  [nakamichi.caraudio](https://www.instagram.com/nakamichi.caraudio)

Made in China | 中國製造