

INSTALLATION

7. Strip the speaker wires and connect them to the amplifier.

- Consult the diagram below. Be sure to connect corresponding terminals, i.e. "+" to "+" and "-" to "-". Connection with reversed polarity will degrade the quality of production.
- Connect the provided speaker cord to the speaker terminal while holding the lower portion of the speaker terminal.

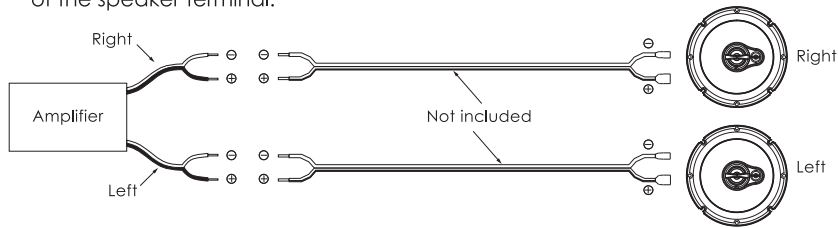

8. Mount on the speaker as shown below.

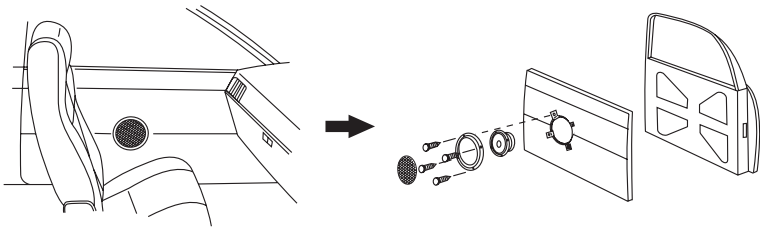

9. Press and insert the edges of the grille net.

- The speaker grille can be mounted without the grille net, if you like.

OPTION 2: MOUNT ON REAR TRAY

You can also mount the speakers into the surface of the rear tray.

Follow the steps in section "Option 1: Mount on door" to mount the speakers into the rear tray.

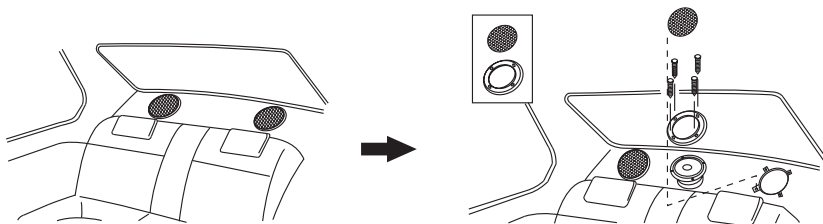

WHAT'S IN THE BOX

Check and identify the contents of your package:

1. Speakers x 2pcs;
2. (Grille Net + Frame) x 2sets;
3. Screw $\varnothing 4 \times 25 \text{mm}$ x 8pcs;
4. Gaskets x 8pcs;
5. User Manual x 1pc;
6. Mounting Template x 1pc



NSE1658 User Manual



6.5" 3-WAY COAXIAL SPEAKER



SCAN OUR QR CODE OR VISIT WWW.NAKAMICHICARAUDIO.COM
FOR COMPLETE AUDIO SETTINGS INSTRUCTIONS

nakamichi.global nakamichi.caraudio

Made in China | 中國製造

YOUR SPEAKER

Dear Customer,

Congratulations on purchasing our Nakamichi mobile system product for your sound system.

This product has been designed and manufactured to Nakamichi's exacting standards to ensure many years of audio enjoyment. For the best performance, we recommend that you have your Nakamichi product installed by an authorized Nakamichi dealer.

If you would like to install this product on your own, we recommend for you to go through this manual to familiarize yourself with all the installation requirements and procedures.

If you encounter any issues or if you have any questions on the operation of this product, please contact your nearest authorized Nakamichi dealer for assistance, or you may also contact us through our website or social media channels.

Installation of Your Product

In today's modern vehicles, it is very easy to cause damage to existing systems through improper installation. Please follow and scrutinize all wiring diagrams to ensure that you have connected everything in its proper place.

If you find yourself uncomfortable or unfamiliar with understanding the wiring and installation diagrams or testing instructions, do contact your nearest Nakamichi dealer to perform the installation for you.

Safety Warnings and Considerations

- Clean only with a dry cloth or other similar materials.
- Install your product in a dry, well-ventilated location that does not interfere with your vehicle's safety equipment.
- Do not block any ventilation openings when installing this product.
- Do not mount the product in the engine compartment of your vehicle or in any areas of extreme heat such as mufflers, silencers, exhaust pipes or other heat producing apparatus.
- Securely mount the product so that it does not come loose in the event of a collision or as a result of repeated vibrations that might occur during normal operation.
- Installation of the apparatus must be done with great care to prevent damage to your vehicle's fuel lines, power, and other electrical wiring, hydraulic brake lines, and other systems. If possible, always visit your nearest Nakamichi dealer to perform the installation.
- Do not run any wiring outside or underneath the vehicle. Keep all wires inside the vehicle.
- Take the necessary precautions when making connections to the vehicle's battery to avoid any potential shock.
- Protect all system wires from sharp edges by carefully routing them, always use rubber grommets to protect wiring and cables whenever you are installing them through metal openings.
- Secure all wiring using cable ties or wire clamps to protect them from moving parts and sharp edges.
- This apparatus shall not be exposed to dripping or splashing, and no object filled with liquids, shall be placed on the apparatus.
- Refer all servicing to qualified service personnel. Servicing is required when the apparatus has been damaged in any way, such as the power input terminals are damaged, liquid has been spilled or objects have fallen into the apparatus, the apparatus has been exposed to rain or moisture, does not operate normally, or has been dropped.
- Fuses shall be replaced only with the correct type and fuse value, and only when the apparatus is powered off.
- Exposure to high sound pressure levels may lead to permanent hearing loss. Take every precaution to protect your hearing.
- This product is designed specifically for use with 12 volt, negative-ground electrical systems only. Using this product in systems with positive ground and/or voltages other than 12V may result in damage to the product and your system.

DIMENSIONS (UNIT: MM)

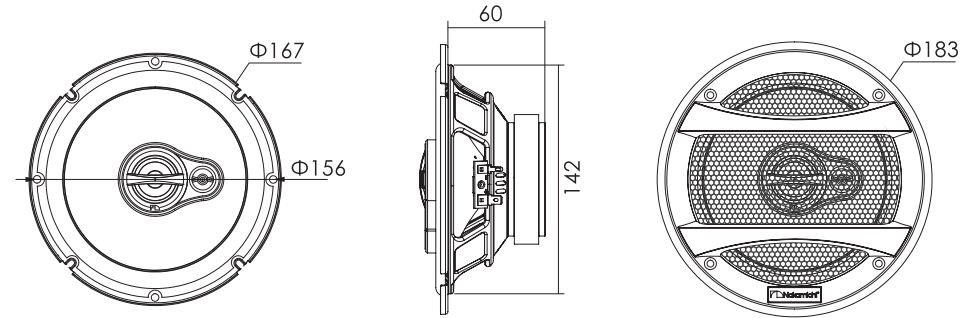

SPECIFICATIONS

Speaker Type:	6.5" (16.5cm) 3-way	Frequency Response:	50-21k Hz
Mounting Depth:	>2.4" (60mm)	Impedance:	4Ω
N-power:	55 watts	Voice Coil:	ASV Φ25.5mm
Peak Power:	360 watts	Magnet Mass:	10 Oz (284g)
Sensitivity (dB/W/m):	89±3 dB	Net Mass (1 pr):	Approx. 1.6kg

INSTALLATION

OPTION 1: MOUNT ON DOOR (FRONT OR REAR)

You can mount the speakers on the front/rear door of your car.

- Make sure that nothing obstructs around the mounting location of the door.
- A hole for mounting may already be cut out of the inner panel of the door(front or rear). If so, you need to modify the board only.
- Ensure that the speaker terminals, frame or magnet do not interfere with any inner parts, (such as the window), etc. Also ensure that the speaker grille does not touch any inner fittings, such as the window cranks, door handles, arm rests etc.

1. Turn off the car ignition key.
 - If the power is on, the click noise generated by the connection may damage the speakers.
2. Cut out the mounting template from the packing box.
3. Paste the template on the location selected for mounting the speaker.
4. Mark the cut-off hole and the 4 bolt holes. (Fig.1)
5. Cut out the marked area and drill the bolt holes. (Fig.2)
6. Remove the grille net. (Fig.3)

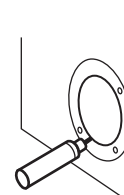

Fig.1

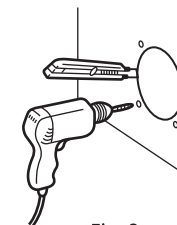

Fig.2

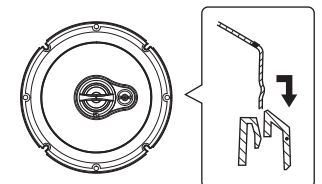

Fig.3