



# NQ623BDT

## User Manual



---

## DIGITAL MEDIA RECEIVER

---

# CONTENTS

Warnings&Precautions .....	1	EN
Product Features .....	2	EN
Accessory List .....	3	EN
Dimension(Unit:mm) .....	3	EN
Wiring Diagram .....	4	EN
Basic Functions Of Panel Keys .....	5	EN
Remote Operation .....	6	EN
Basic Operation .....	6	EN
Radio Operation .....	7	EN
Start Listening .....	7	EN
Tuner Settings .....	7	EN
Tunner Settings List .....	7	EN
Stereo/Mono Select .....	7	EN
DX/Local Select .....	7	EN
Tuner Area Select .....	7	EN
RDS ON/OFF .....	7	EN
USB&SD Playback .....	8	EN
Supported Audio Playback List .....	8	EN
Supported Devices .....	8	EN
Bluetooth Operation .....	9	EN
Bluetooth Pairing .....	9	EN
Bluetooth Basic Operation .....	9	EN
Bluetooth Music Operation .....	9	EN
AUX Input .....	10	EN
External Microphone .....	10	EN
Audio Settings .....	11	EN
Audio Settings List .....	11	EN
Subwoofer Volume Adjustment .....	11	EN
Preset EQ Select .....	11	EN
User EQ Setup .....	11	EN
X-BASS Adjustment .....	11	EN
Audio Settings .....	12	EN
3D Surround Setup .....	12	EN
DRC Gain adjustment .....	12	EN
DRC Slope Select .....	12	EN
Loudness Setup .....	12	EN
Bass Adjustment .....	12	EN
Treble Adjustment .....	12	EN
Balance Adjustment .....	12	EN
Fader Adjustment .....	12	EN
Audio Setup Reset .....	12	EN
Subwoofer Xover Setup .....	13	EN
Subwoofer Xover List .....	13	EN
Subwoofer Frequency Setup .....	13	EN
Subwoofer Phase Setup .....	13	EN
Subwoofer Gain Setup .....	13	EN
Subwoofer Slope Setup .....	13	EN
DTA Settings .....	14	EN
DTA Settings List .....	14	EN
Car Type Settings .....	14	EN
Listening Position Settings .....	14	EN
Delay Unit Settings .....	14	EN
DSP Reset .....	14	EN
Time Alignment(Distance) .....	15	EN
Clock And Date Settings .....	16	EN
Clock And Date Settings List .....	16	EN
Clock Format Settings .....	16	EN
Clock Adjust .....	16	EN
Date Format Settings .....	16	EN
Date Settings .....	16	EN
Display Settings .....	16	EN
Display Settings List .....	16	EN
Display Settings .....	17	EN
Key Light Select .....	17	EN
Spectrum On/Off .....	17	EN
ID3 On/Off .....	17	EN
System Version .....	17	EN
Animation Settings .....	17	EN
Demo Mode Select .....	17	EN
APP Operation .....	18	EN
APP Download .....	18	EN
APP Connection .....	18	EN
APP Operation .....	18	EN
Trouble Shooting .....	19	EN
Speaker Connection .....	20	EN
Specification .....	20	EN
Specification .....	21	EN

## WARNINGS & PRECAUTIONS

---

To avoid risk of serious injury or possible violation of laws, please read the following thoroughly before installation or connecting.

- This product is designed specifically for use with 12 volt, negative ground electrical systems only.
- Having the wiring and installation done by expert.  
Be sure to disconnect the cable from the negative battery terminal while installation.
- This apparatus shall not be exposed to dripping or splashing, and no object filled with liquids, shall be placed on the apparatus.
- Fuses shall be replaced only with the correct type and fuse value, and only when the apparatus is powered off.
- To prevent a short circuit, never put or leave any metallic objects (such as coins or metallic tools) inside the unit.
- Never set the volume of this product so high that you cannot hear outside traffic and emergency vehicles.







## PRODUCT FEATURES

---

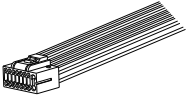
Panel	Fixed
LCD	2-Line VA-LCD
Key Light	Multi Color
Bluetooth	Version 5.0
Bluetooth Music	Support
DSP	Built-in
EQ	40 band,8 Preset
Pre-Output	6CH x 4V
Max Power	4 x 50W
DRC	Support
Xbass	Support
Xover	Support
3D Surround	Support
Time alignment	0-20 ms
Q Value	1-20
Subwoofer Control	Support
Playback Interface	TF&USB
Phase	0° -180°
Listening bit setting	Support
Slope	0dB-24dB
PAC™-SWI	Support
Remote	Support
Microphone	Built-in and External
Radio	Preset 18FM,12AM, RDS
APP Control	iOS and Android Phone
Charge	Front USB 1A
Audio Format	MP3,WMA,AAC,FLAC,APE

## ACCESSORY LIST

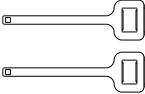
Please check the following accessories after opening the package:

<p>16P cable x1</p> 	<p>Remote x1</p> 	<p>Frame x1</p>  <p>Install on the host</p>
<p>Half sleeve x1</p>  <p>Install on the host</p>	<p>Diassemble keys x2</p> 	<p>User Manual x1</p> 

## DIMENSION(UNIT:MM)

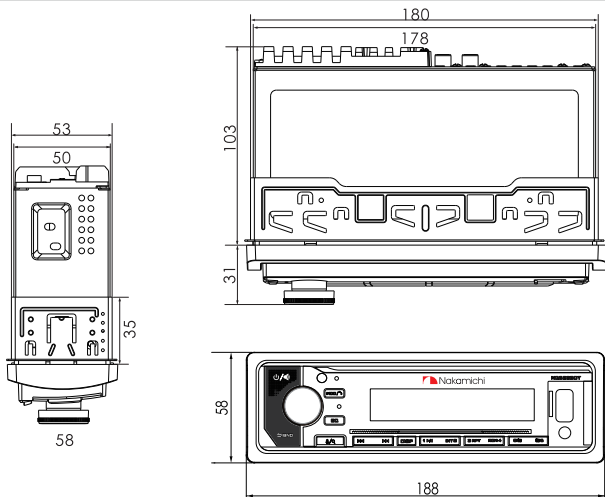

# WIRING DIAGRAM

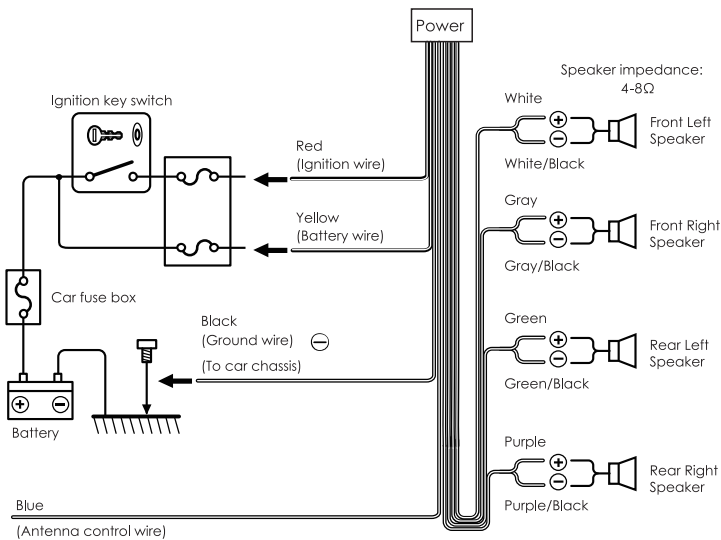
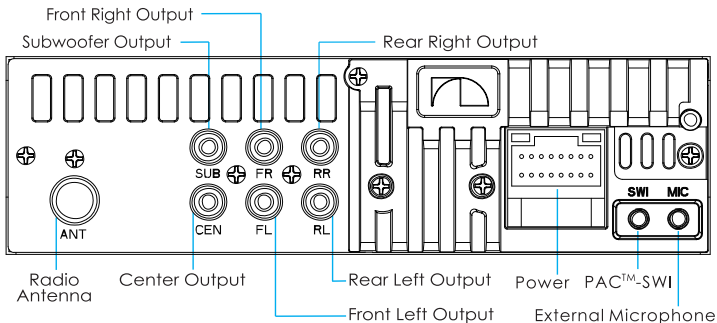

## BASIC FUNCTIONS OF PANEL KEYS

To	Radio status	USB/TF/BT MUSIC Status
◀▶	Seek a station manually	Previous/Next track
1 ▶/II	Preset 1	Playback/Pause
INT 2	Preset 2	Intro Playback
3 RPT	Preset 3	Repeat Playback
RDM 4	Preset 4	Random Playback
5 6	Preset 5/Preset 6	Previous/Next folder
↶/BND	Band select	
⏻/🔊	Press to mute, Press and hold to power off	
🗣️/Q	Press to turn on voice, Press an hold to auto memory	
↶/MOD	Press to select a source/Answer call Press an hold to last call	
EQ	Press to EQ settings	
DISP	Press to meter 8 shows the time	

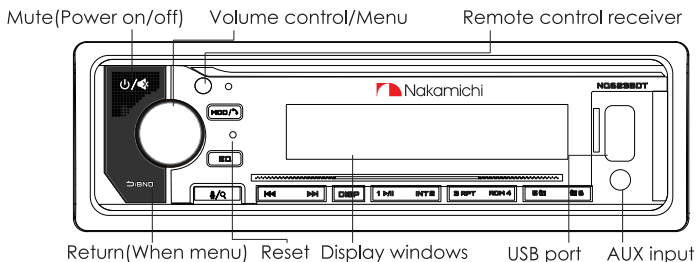

# REMOTE OPERATION

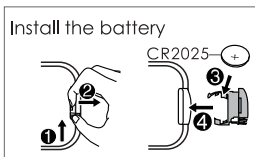

## Basic Operation

To	Operation (panel)
Power on	Press any button
Power off	Press and hold /
Mute	Press /
Volume up and down	Turn the knob
Source select	Press /MOD
Menu	Press the knob
Return	Press /BND (In menu status)
Turn on voice	Press  (Bluetooth is connected)



# RADIO OPERATION

## Start Listening

To	Operation (panel)	Remark
Auto memory	Press and hold Q	18 FM/12AM
Band selection	Press $\rightarrow$ /BND	FM1/FM2/FM3/AM1/AM2
Seek a station manually	Press $\lll$ $\ggg$	
Search the next or previous frequency step by step	Press and hold $\lll$ $\ggg$	
Store a station	Press and hold 1-6	

## TUNER SETTINGS

- 1.Press the knob to enter the [MENU].
- 2.Turn the knob to select [TUNER],then press the knob.

### Tuner Settings List

Menu	Adjustment	
TUNER	STEREO/MONO	NEWS/AFFAIRS/INFO/SPORT
	DX/LOCAL	EDUCATE/DRAMA/CULTURE
	REGIONAL EUROPE/USA/ASIA/RUSSIA	SCIENCE/VARIED/POP M/ROCK
	RDS OFF/ON	MEASY M/LIGHT M/CLASSICS
		OTHER M/WEATHER/FINANCE
		CHILDREN/SOCIAL/RELIGION
		PHONE IN/TRAVEL/LEISURE
	EON OFF/ON	JAZZ/COUNTRY/NATION M
	REG OFF/ON	OLDIES/FOLK M/DOCUMENT
	PTY OFF/ON	

### Stereo/Mono Select

Turn the knob to select [STEREO or MONO],then turn the knob select [STEREO/MONO].

### DX/Local Select

Turn the knob to select [LOC or DX],then turn the knob select [DX /LOCAL].

Remark: DX:Distant exchange

### Tuner Area Select

Turn the knob to select [REGIONAL],then turn the knob select [ASIA/OIRT/EUR/USA].

### RDS ON/OFF

Turn the knob to select [RDS OFF],then turn the knob select [RDS OFF,ON].

## USB&SD PLAYBACK

To	Operation (panel)
Track selection	Press <b>⏮ ⏭</b>
Fast playback	Press and hold <b>⏮ ⏭</b>
Playback/Pause	Press <b>1/▶  </b>
Track pre-play	Press <b>INT 2</b>
Repeat playback	Press <b>3 RPT</b> • REPEAT ONE.REPEAT DIR.REPEAT ALL
Random playback	Press <b>RDM 4</b> • ON/OFF
Folder selection	Press <b>5 [Folder] 6</b>

## SUPPORTED AUDIO PLAYBACK LIST

Audio	Stream	Sampling Rate	Remark
MP3	32kbps-384kbps	8/11.025/12/16/22.05 24/32/44.1/48KHz	MPEG1/2/2.5 Layer II&III
WMA	0kbps-320kbps	8/11.025/12/16/22.05 24/32/44.1/48KHz	WMA standard 4/4/1/7/8/9.1
APE	all bitrates allowed	8/16/22.05/24/32 44.1/48KHz	PCM Bit width 8/12/16/24bits
FLAC	all bitrates allowed	8/16/22.05/24/32 44.1/48/96KHz	PCM Bit width 8/12/16/24bits
AAC	all bitrates allowed	8/11.025/12/16/22.05 24/32/44.1/48KHz	MPEG2/4 AAC LC profile
M4A	all bitrates allowed	8/11.025/12/16/22.05 24/32/44.1/48KHz	ISO/IEC 14496-3 Amd 1:2003
WAV	32kbps-384kbps	8/11.025/12/16/22.05 24/32/44.1/48KHz	4 bit ADPCM only

## SUPPORTED DEVICES

Device	Maximum capacity	Device format
USB	256GB	FAT16/FAT32/exFAT
Micro SD/TF	256GB	FAT16/FAT32/exFAT

# BLUETOOTH OPERATION

## Bluetooth Pairing

The first time pair mobile phone with receiver, please follow below steps:

1. When there is no pairing, in any mode, the BT1 on the LCD will flash, and the pairing can be performed at this time.
2. Turn on the phone's Bluetooth to Search NQ623BDT.
3. Click on the NQ623BDT on the phone to connect. After the connection is successful, the BT1 will stop flashing.
4. When pairing is complete, the mobile phone audio will automatically transfer to the car audio system whenever a call is made or received, or when the mobile phone plays music.

### Note:

For more details of bluetooth pairing, please refer to the owner's manual for your mobile phone.

## Bluetooth Basic Operation

To	Operation (panel)
Make a call	Bluetooth mobile phone connected
Answer a call	Press <b>↵/MOD</b>
Reject an incoming call	Press an hold <b>↵/MOD</b>
Switch between the current caller and a caller on hold	Press <b>↵/MOD</b> (In a call)
End a call	Press an hold <b>↵/MOD</b> (In a call)
Adjust call volume	Turn on the knob

## Bluetooth Music Operation

To	Operation (panel)
Previous track	Press <b>⏮</b>
Next track	Press <b>⏭</b>
Playback/Pause	Press <b>1/⏩</b>

## AUX INPUT

1. Connect a portable audio player (commercially available).  
Auxiliary input jack

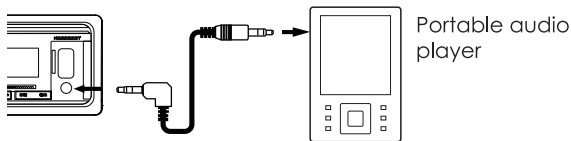

Auxiliary input jack

3.5mm stereo mini plug with "L" shaped connector.  
(commercially available).

2. Press [  /MOD ] buttons to select AUX IN.
3. Turn on the portable audio player and start playback.

## EXTERNAL MICROPHONE

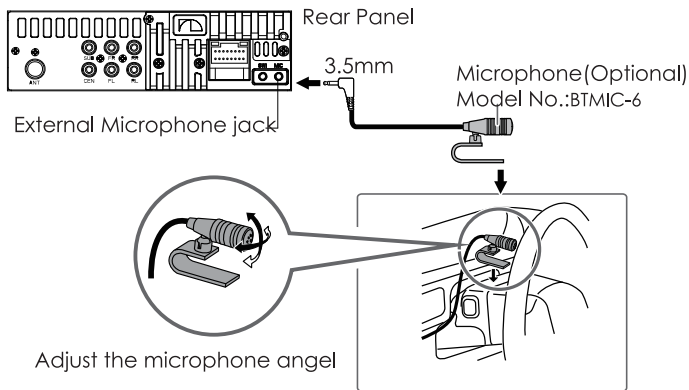

### Note:

Since the panel microphone is far from the driver's position, when using an external microphone, you can get better voice calls.

## AUDIO SETTINGS

- 1.Press the knob to enter the [MENU].
- 2.Turn the knob to select [AUDIO],then press the knob.

### Audio Settings List

Menu	Adjustment
SW LEVEL	SVOL -8 ~ +8
PRESET EQ	USER/NATURAL/POP/CLASSIC/ROCK/JAZZ/FLAT/SUPER BASS └ 30Hz/60Hz/80Hz/100Hz/120Hz/160Hz/250Hz/400Hz 600Hz/ 800Hz/1KHz/1.5KHz/2KHz/2.5KHz/3KHz/3.5K/4K 4.5K/5K/5.5K/ 6K/6.5K/7K/7.5K/8K/8.5K/9K/9.5K/10K/11K /12K/13K/14K/15K/ 15.5K/16K/17K/18K/19K/20K
XBASS	FREQ OFF/60Hz/80Hz/120Hz/160Hz/200Hz/300Hz
	GAIN 0~10
SURROUND	OFF/ON (3D SURROUND)
DRC	GAIN 0~5
	SLOPE 0/6dB/12dB/18dB/24dB
LOUD	OFF/ON
BASS	BASS -7 ~ +7
TREBLE	TREBLE -7 ~ +7
BALAN	BALAN L7-L0,0,R1-R7 (BALANCE)
FADER	FADER R7-R0,0,F1-F7
AUDIO RESET	NO/YES

### Subwoofer Volume Adjustment

- 1.Turn the knob to select [SW LEVEL],then press the knob.
- 2.Turn the knob to adjustment SVOL [ -8 to +8].

### Preset EQ Select

- 1.Turn the knob to select [PRESET EQ ],then press the knob.
- 2.Turn the knob to select [USER/NATURAL/POP/CLASSIC/ROCK/  
JAZZ/FLAT/SUPER BASS].

### User EQ Setup

- 1.Turn the knob to select [PRESET EQ ],then press the knob.
- 2.Turn the knob to select [USER],then press the knob.
- 3.Turn the knob to select frequency for adjustment.

### X-BASS Adjustment

- 1.Turn the knob to select [XBASS],then press the knob.
- 2.Turn the knob to adjustment [0-20].

## AUDIO SETTINGS

---

- 1.Press the knob to enter the [MENU].
- 2.Turn the knob to select [AUDIO],then press the knob.

### 3D Surround Setup

- 1.Turn the knob to select [SURROUND],then press the knob.
- 2.Turn the knob to select [OFF/ON].

### DRC Gain adjustment

- 1.Turn the knob to select [DRC],then press the knob.
- 2.Turn the knob to select [GAIN],then press the knob.
- 3.Turn the knob to adjustment[0-5].

#### Remark:

DRC: Dynamic range compression.

Can make small signals louder and stronger, and make high-amplitude signals undistorted.

### DRC Slope Select

- 1.Turn the knob to select [DRC],then press the knob.
- 2.Turn the knob to select [SLOP],then press the knob.
- 3.Turn the knob to select [0DB/6DB/12DB/24DB].

### Loudness Setup

- 1.Turn the knob to select [LOUND],then press the knob.
- 2.Turn the knob to select [OFF/ON].

### Bass Adjustment

- 1.Turn the knob to select [BASS],then press the knob.
- 2.Turn the knob to adjustment [-7 to +7].

### Treble Adjustment

- 1.Turn the knob to select [TREBLE],then press the knob.
- 2.Turn the knob to select [-7 to +7].

### Balance Adjustment

- 1.Turn the knob to select [BALAN],then press the knob.
- 2.Turn the knob to select [ L7-L0 toR1-R7].

### Fader Adjustment

- 1.Turn the knob to select [FADER],then press the knob.
- 2.Turn the knob to select [ R7-R0 toF1-F7].

### Audio Setup Reset

- 1.Turn the knob to select [AUDIO RESET],then press the knob.
- 2.Turn the knob to select [NO/YES].

## SUBWOOFER XOVER SETUP

---

- 1.Press the knob to enter the [MENU].
- 2.Turn the knob to select [X/OVER],then press the knob.
- 3.Turn the knob to select [SUB SET],then press the knob.

### Subwoofer Xover List

Menu	Adjustment	
SUB SET	SW FREQ	OFF/30Hz/60Hz/80Hz/100Hz/120Hz, 150Hz/180Hz/200Hz/250Hz/300Hz
	SW PHASE	NORMAL/REVERSE
	SW GAIN	0-5
	SW SLOPE	0dB/6dB/12dB/18dB/24dB

### Subwoofer Frequency Setup

- 1.Turn the knob to select [SW FREQ ],then press the knob.
- 2.Turn the knob to select frequency[OFF/30Hz/60Hz/80Hz/100Hz/120Hz  
150HZ/180HZ/200H/250HZ/300HZ ].

### Subwoofer Phase Setup

- 1.Turn the knob to select [SW PHASE],then press the knob.
- 2.Turn the knob to select [NORMAL/REVERSE].

### Subwoofer Gain Setup

- 1.Turn the knob to select [SW GAIN],then press the knob.
- 2.Turn the knob to select [0-5].

### Subwoofer Slope Setup

- 1.Turn the knob to select [SW LPF SLOPE],then press the knob.
- 2.Turn the knob to select [0dB/6dB/12dB/18dB/24dB].

## DTA SETTINGS

---

- 1.Press the knob to enter the [MENU].
- 2.Turn the knob to select [DTA SET],then press the knob.

### DTA Settings List

Menu	Adjustment	
CAR TYPE	SMALL/MEDIUM /LARGE	
POSITION	USER/FRONT R/FRONT L/CENTER	
UNIT	CM/MS/INCH	
DISTANCE	F LEFT	FL 0-680CM
	F RIGHT	FR 0-680CM
	R LEFT	RL 0-680CM
	R RIGHT	RR 0-680CM
	SUBWOOFER	SUB 0-680CM
DTA RST	NO/YES	

### Car Type Settings

- 1.Turn the knob to select [CAR TYPE],then press the knob.
- 2.Turn the knob to select [SMALL /MEDIUM /LARGE].

### Listening Position Settings

- 1.Turn the knob to select [POSITION],then press the knob.
- 2.Turn the knob to select [USER/FRONT R/FRONT L/CENTER].

### Delay Unit Settings

- 1.Turn the knob to select [UNIT],then press the knob.
- 2.Turn the knob to select [CM/MS/INCH].

### DSP Reset

- 1.Turn the knob to select [DTA RST],then press the knob.
- 2.Turn the knob to select [NO/YES].



## TIME ALIGNMENT(DISTANCE)

---

- 1.Press the knob to enter the [MENU].
- 2.Turn the knob to select [DTA SET],then press the knob.
- 3.Turn the knob to select [DISTANCE],then press the knob.
- 4.Turn the knob to select[F LEFT/F RIGHT/R LEFT/R RIGHT/SUBWOOFER] to adjustment.

### Determining the value for<Position> adjustment.

- ① Determine the center of the currently set listening position as the reference point.
- ② The adjustable speaker has five directions: front left, front right, back left, back right, and back.
- ③ The time for the speakers in the five directions to reach the center is the same by default.
- ④ Set the value for each speaker, the delay range: 0-20ms
- ⑤ Adjust the increase or decrease of each speaker, 0.2ms each time.

**Example:** When <back> is selected as the listening position

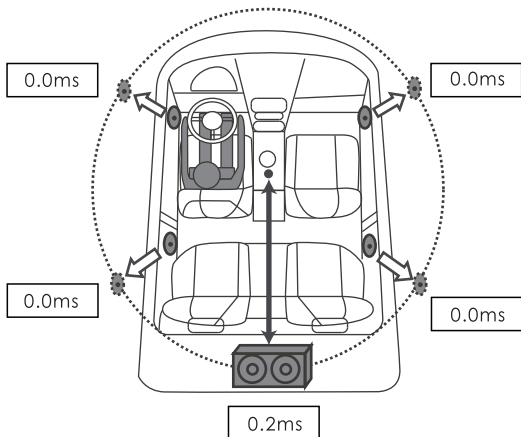

## CLOCK AND DATE SETTINGS

---

- 1.Press the knob to enter the [MENU].
- 2.Turn the knob to select [CLOCK],then press the knob.

### Clock And Date Settings List

Menu	Adjustment
CLK FRMT	12H/24H
CLK ADJ	00:00
DATE FRMT	DD-MM-YY/MM-DD-YY
DATE SET	17/07/21

### Clock Format Settings

- 1.Turn the knob to select [CLK FRMT],then press the knob.
- 2.Turn the knob to select [12H/24H].

### Clock Adjust

- 1.Turn the knob to select [CLK ADJ],then press the knob.
- 2.Turn the knob to adjustment.
- 3.Press the knob to switch the clock/minute adjustment.

### Date Format Settings

- 1.Turn the knob to select [DATE FORMAT],then press the knob.
- 2.Turn the knob to select [DD-MM-YY/MM-DD-YY].

### Date Settings

- 1.Turn the knob to select [DATE SET],then press the knob.
- 2.Turn the knob to adjustment.
- 3.Press the knob to switch day/month/year adjustment.

## DISPLAY SETTINGS

---

### Display Settings List

Menu	Adjustment
COLOR SEL	AUTO/RED/GREEN/BLUE/YELLOW/ CYAN/PURPLE/WHITE
SPECTRUM	OFF/ON
ID3 TAG	OFF/ON
VERSION	VER 2.0

## DISPLAY SETTINGS

---

- 1.Press the knob to enter the [MENU].
- 2.Turn the knob to select [DISPLAY],then press the knob.

### Key Light Select

- 1.Turn the knob to select [COLOR SEL],then press the knob.
- 2.Turn the knob to select key light color:AUTO/RED/GREEN /BLUE/YELLOW/CYAN/PURPLE/WHITE(Knob Select).

### Spectrum ON/OFF

- 1.Turn the knob to select [SPECTRUM],then press the knob.
- 2.Turn the knob to select [OFF/ON].

### ID3 ON/OFF

- 1.Turn the knob to select [ID3 TAG],then press the knob.
- 2.Turn the knob to select [OFF/ON].

### System Version

Turn the knob to select [VERSION],then press the button to query the system version information.

## ANIMATION SETTINGS

---

- 1.Press the knob to enter the [MENU].
- 2.Turn the knob to select [ANIMATION],then press the knob.
- 3.Turn the knob to select [OFF/PER 15SEC/30SEC/1MIN/2MIN/4MIN].

Menu	Adjustment
ANIMATION	OFF/PER 15SEC/30SEC/1MIN/2MIN/4MIN

## DEMO MODE SELECT

---

- 1.Press the knob to enter the [MENU].
- 2.Turn the knob to select [DEMO MODE],then press the knob.
- 3.Turn the knob to select [OFF/ON].

Menu	Adjustment
DEMO MODE	OFF/ON

# APP OPERATION

## APP Download

Please go to the APPALE APP Store or Google Play Store and search [Nakamichi AMC] app, after downloading the APP, install it on your Appale&Android devices.

## APP Connection

1. Open the [Nakamichi AMC] APP, click [🔍] to search for NQ623BDT.
2. Click NQ623BDT to connect, the [🔴] will be red after the connect is successful.

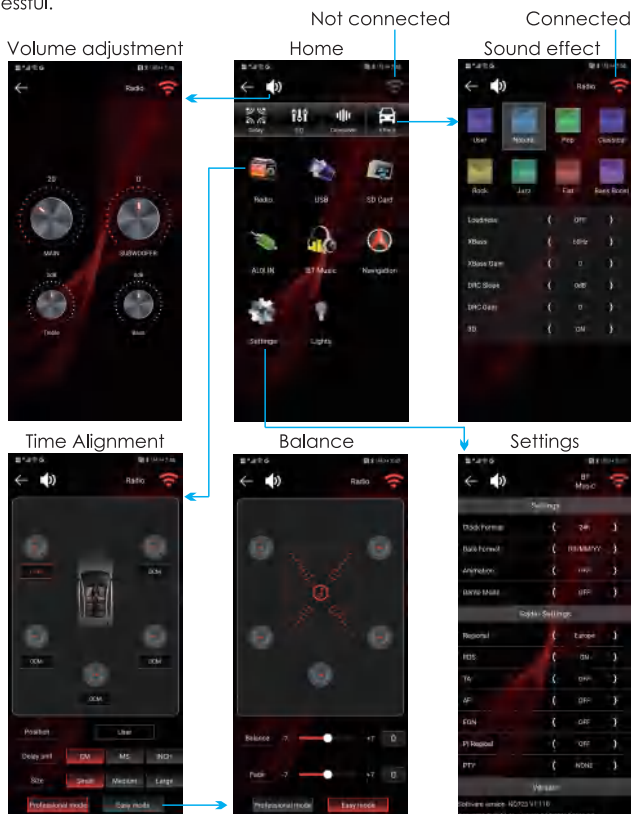

# APP OPERATION

## EQ Settings

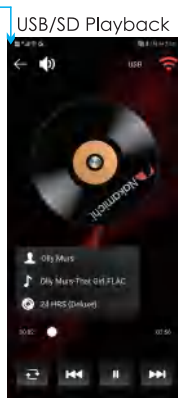
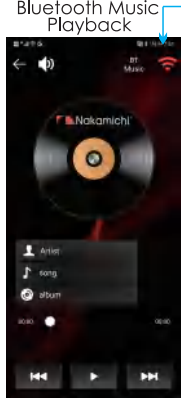
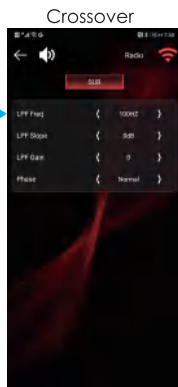
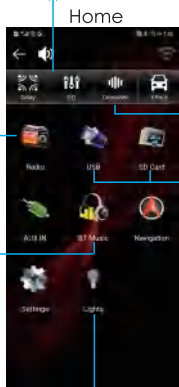
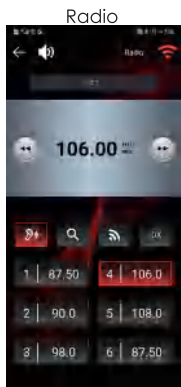
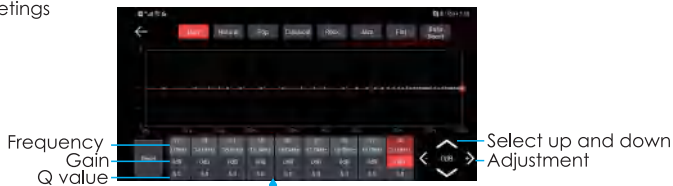

## TROUBLE SHOOTING

---

### Not work

Fuse blown  
Loose panel contact

### Remedy

Replace the fuse: small 10A(Red)  
Take out the panel and reinstall

### Not responding

System problem

Reset the unit

### No bass

Subwoofer setting level  
is too small

Enter AUDIO to set SVOL

### Can't turn on voice

Bluetooth is not connected  
Phone does not support voice

Connect Bluetooth  
N.A

### Not playing

Incorrect device format  
Device error  
Unsupported audio file

Reformat  
Replacement device  
Replace supported audio files

### Radio reception is poor

Poor contact of radio antenna  
Poor signal at location

Reconnect the radio antenna  
Change to other positions

### Remote control is invalid

Remote control battery is low

Replace CR2025 battery

### Bluetooth call is poor

Microphone is too far away

Speak into the microphone

## SPEAKER CONNECTION

---

Do not connect the speaker leads of the power cord to the car battery; otherwise, the unit will be seriously damaged.

Before connecting the speaker leads of the power cord to the speakers, check the speaker wiring in your car.

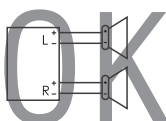
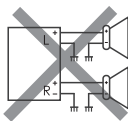
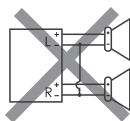

## SPECIFICATION

GENERAL	Operating Voltage	14.4V(10.8V allowable)
	Maximum Current	10A
	Operational Temperature	-10°~+60°
	Installation Size(WxHxD)	182mmx53mmx115mm
	Net Weight	0.5kg
	Fuse	Small fuse 10A(Red)

AUDIO	Maximum Output Power	50Wx4
	Speaker Impedance	4-8ohm
	Pre-output Level	4V

RADIO	FM Frequency Range	87.5MHz-108.0MHz
	AM Frequency Range	522KHz-1710KHz
	Preset	18 FM,12 AM

USB	USB Standard	USB1.1,USB2.0 Full Speed
	Audio Format	MP3/WMA/APE/FLAC/ AAC/M4A/WAV
	Front USB	Read/charge DC 5V $\pm$ 1A

BLUETOOTH	Version	Bluetooth 5.0
	Frequency Range	2.402GHz-2.480GHz
	Communication Range	Line of sight approx.10m
	Profile	HPF1.6/A2DP/AVR/SPP



CONNECT WITH US ONLINE TO EXPLORE NAKAMICHI'S COMPLETE RANGE,  
INSTRUCTIONS & SOFTWARE DOWNLOADS AND WARRANTY REGISTRATION.

[WWW.NAKAMICHICARAUDIO.COM](http://WWW.NAKAMICHICARAUDIO.COM)

 [nakamichi.global](https://www.facebook.com/nakamichi.global)  [nakamichi.caraudio](https://www.instagram.com/nakamichi.caraudio)

Made in China | 中國製造