



# NKTA60.4

User Manual



## 4 CHANNEL POWER AMPLIFIER



# INTRODUCTION

---

Thank you for your purchase of our Nakamichi product and we warmly welcome you to the Nakamichi family! Do keep your original invoice and purchase receipt in a safe place in case of future service and warranty claims. You may also contact your appointed Nakamichi service agent for any future technical support requirements.

## ACCESSORY LIST

---

1. User Manual	2pcs
2. Amplifier	1pc
3. Mounting Screw ( $\Phi$ 4x20mm)	4pcs
4. Fuse(20A)	2pcs

## SPECIFICATIONS

---

N-power Output@4 $\Omega$	60Wx4
N-power Output@2 $\Omega$	70Wx4
N-power Output@4 $\Omega$ (bridged)	120Wx2
Max power	1500W
Frequency Response	20Hz-20kHz
Signal To Noise Ratio	$\geq$ 90dB
Sensitivity	0.15V-8V
Fuse Size	20Ax2
Unit Dimensions(LxHxW)	318x217x50mm
Net Weight	Approx. 2.1kg
Box Dimensions(LxHxW)	420x267x87mm
Gross Weight	Approx. 2.5kg

All specifications subject to change without notice.

# DIMENSIONS (UNIT:MM)

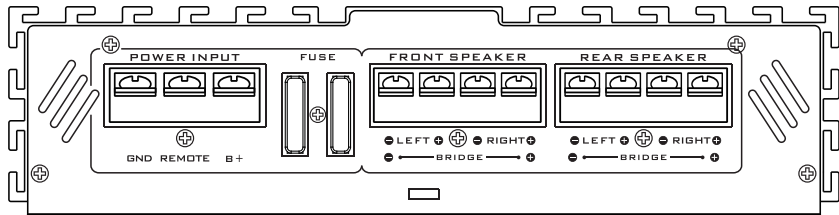
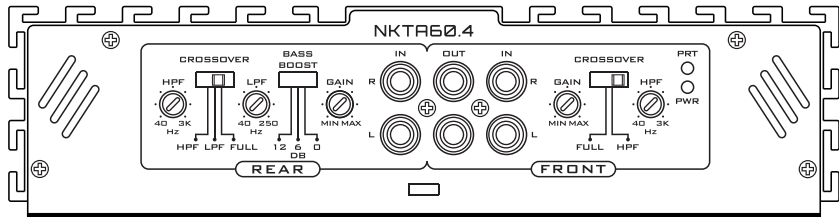
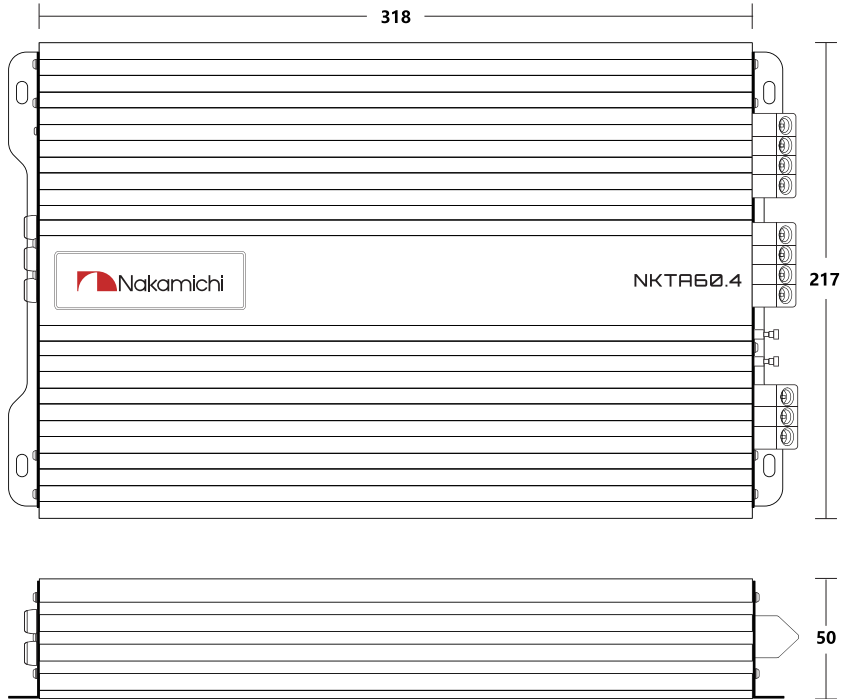

# POWER CONNECTION LEADS

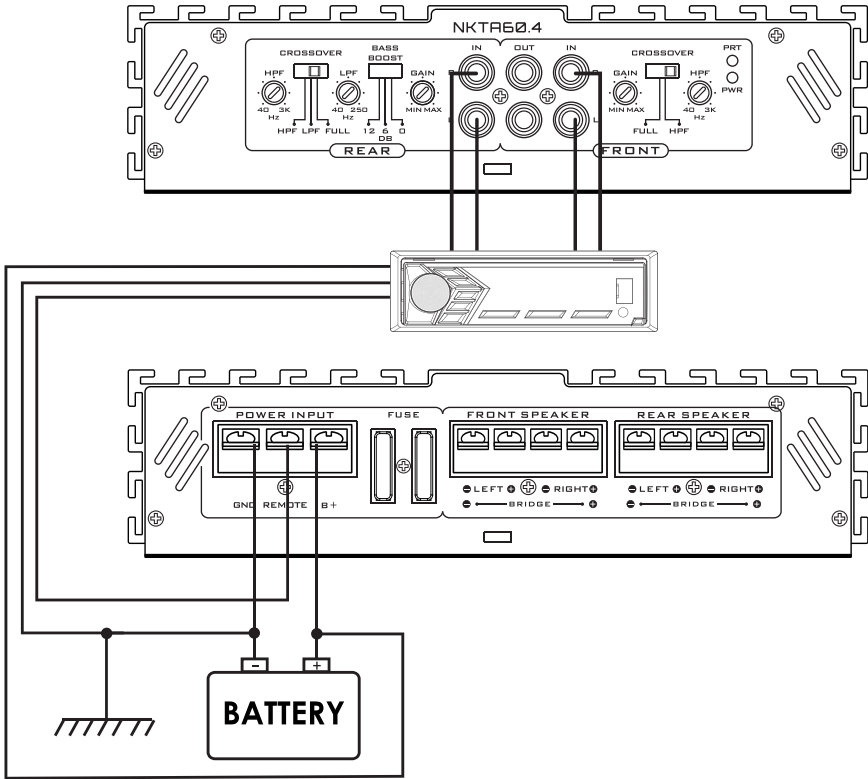

## Notes on the power supply

Connect the +12V power input lead only after all other leads have been connected. Be sure to connect the ground wire of the unit securely to a metal part of the car. A loose connection may cause a malfunction of the amplifier.

## REMOTE:

The unit is turned on by applying +12Volts to this terminal. This terminal does not draw heavy current like the two power terminal so a thinner connecting wire is acceptable. Standard 18 GAUGE is fine and the standard colour is yellow. If the radio is equipped with a power antenna control wire, it can drive this terminal. If the power antenna wire is already in use, you can still splice into it. With this method, the unit will turn on automatically with the radio.

# POWER CONNECTION LEADS

Use the power supply lead with a fuse attached whose value is the same as original fuse. Place the fuse in power supply lead as close as possible to the car battery.

During a full power operation, Maximum current will run through the system. Therefore. Make sure the that the leads to be connected to the +12V and GND terminals of the unit respectively must be larger than 8-Gauge(AWG.8).

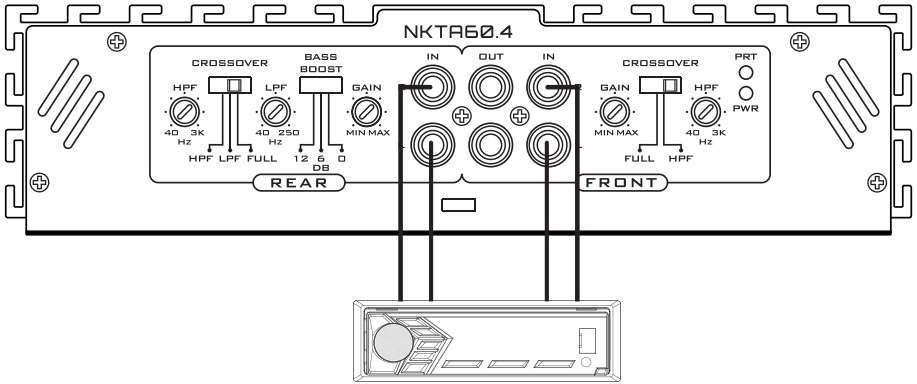

## CONNECTION 1: 4-CHANNEL MODE

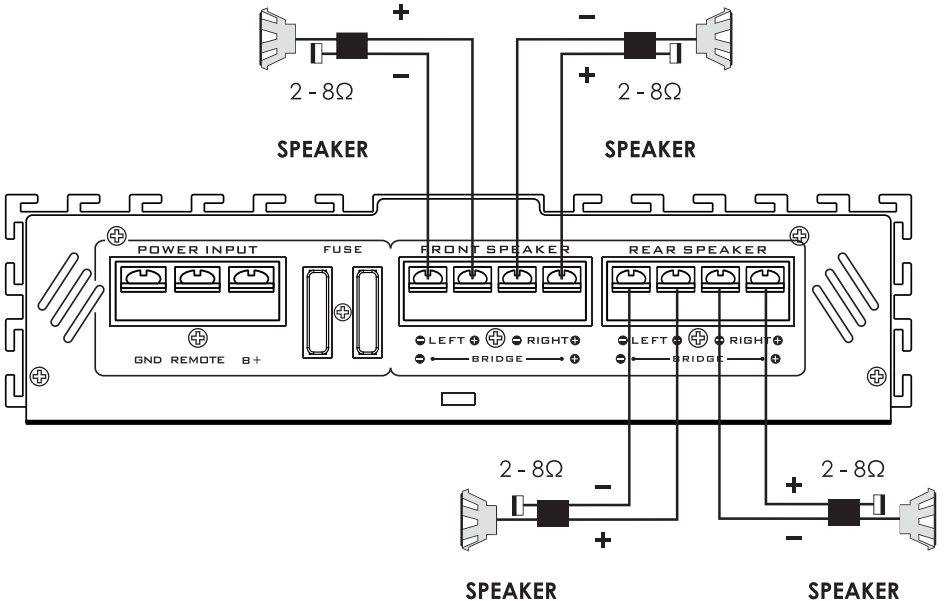

# POWER CONNECTION LEADS

## CONNECTION 2: 3-CHANNEL MODE

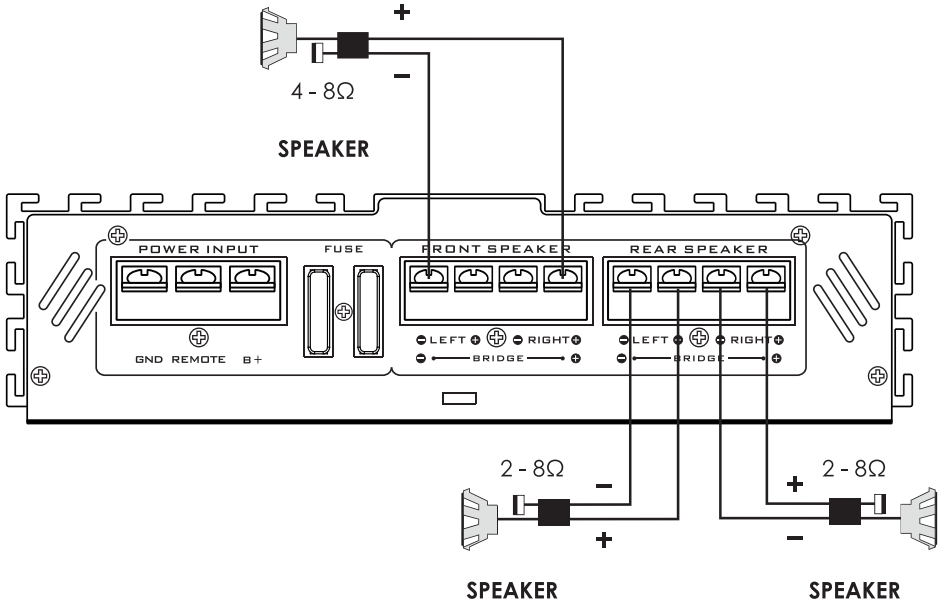

## CONNECTION 3: 2-CHANNEL MODE

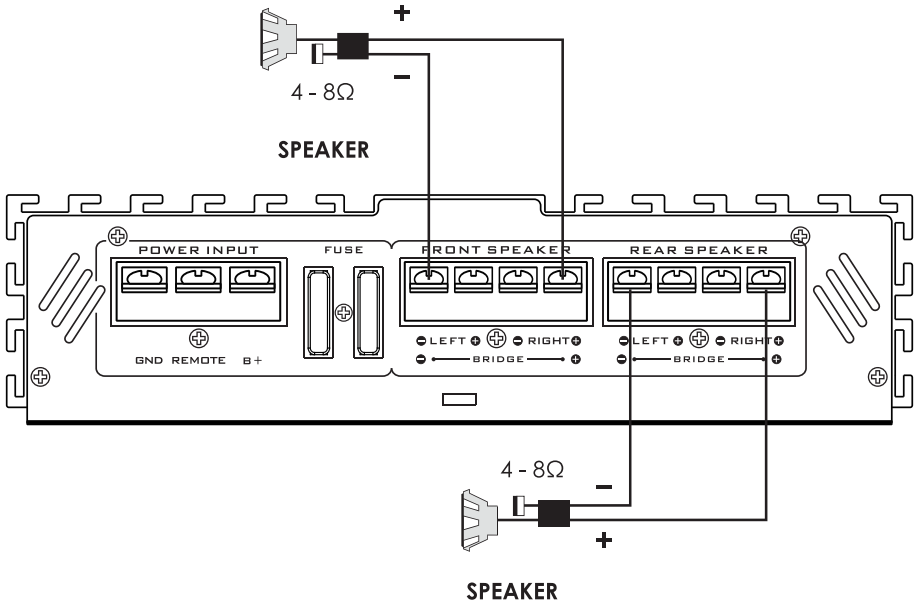

# PANEL CONTROLS AND FEATURES

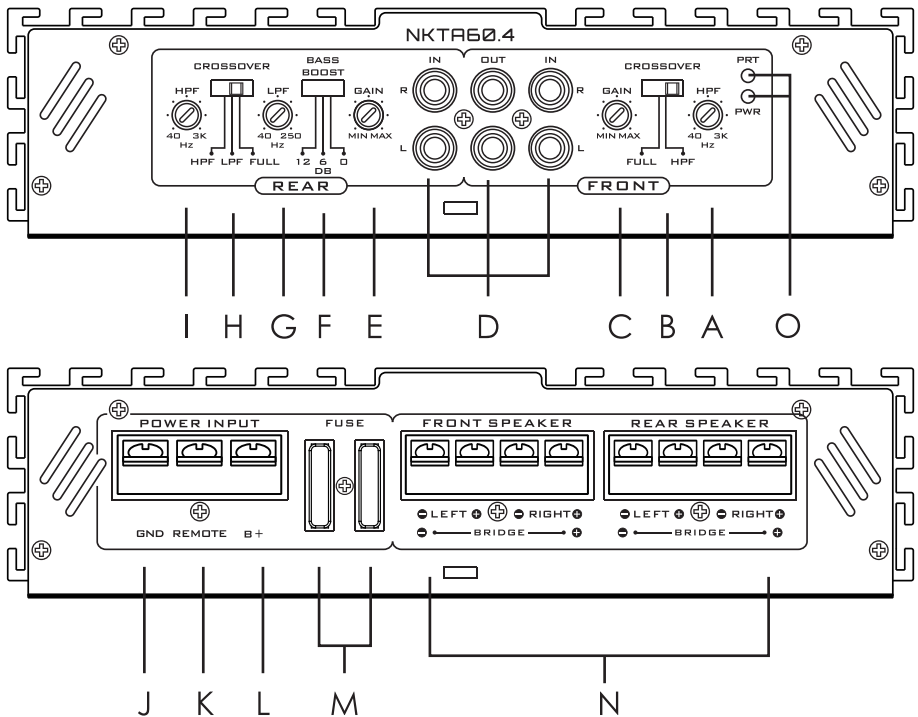

## A. FRONT SPEAKER HIGH PASS CROSSOVER FREQUENCY

Controls high frequency of the amplifier between 40Hz to 3KHz.

## B. FRONT SPEAKER CROSSOVER CONTROL

Depending on the selected switch the amplifier will operate at full or high pass mode.

## C. FRONT SPEAKER GAIN CONTROL

The gain control will match the amplifiers sensitivity to the source signal voltage.

## D. LOW LEVEL RCA INPUT

These RCA input jacks connect with your source unit RCA low level outputs or via optional adapter with your source unit speaker high level outputs. The use of high quality twisted pair car audio cables is recommended to reduce the possibility of audio signal degradation.

## E. REAR SPEAKER GAIN CONTROL

The gain control will match the amplifiers sensitivity to the source signal voltage.

## F. BASS BOOST

The BASS BOOST feature will increase the sound level in the bass frequencies.



# PANEL CONTROLS AND FEATURES

---

## G. REAR SPEAKER LOW PASS CROSSOVER FREQUENCY

Controls low frequency of the amplifier between 40Hz to 250Hz.

## H. REAR SPEAKER CROSSOVER CONTROL

Depending on the selected switch the amplifier will operate at full, low pass or high pass mode.

## I. REAR SPEAKER HIGH PASS CROSSOVER FREQUENCY

Controls high frequency of the amplifier between 40Hz to 3KHz.

## J. GND(-) = GROUND CONNECTION

Connect this cable directly to the metal frame of the vehicle, ensuring that the metal frame has been stripped of all paint down to the bare metal. Use the shortest distance possible. It is always a good idea to replace the vehicle battery ground terminal or any other factory ground points.

## K. REM(ON/OFF) REMOTE CONTROL

When using HI-INPUT, the amplifier can detect the DC offset from the high level input signal to automatically turn the amplifier on or off. When the amplifier turns on, the REM terminal will output +12V DC to control the other devices to turn on or off. When using low level inputs, the amplifier REM-IN should be connected to the REM-OUT of the source unit. The source unit will control the amplifier to automatically turn on or off.

## L. +12V = POWER SUPPLY

Connect this terminal through a fuse or circuit breaker to the positive terminal of the vehicle battery or the positive terminal of an isolated audio system battery.

## M. FUSE

Do not use a fuse with a different value and NEVER replace the fuse with a wire or coin.

## N. SPEAKER CONNECTIONS

Connect your speakers and woofers to their terminals, ensuring proper polarity during connection. Never connect the speaker cables to the chassis ground.

## O. POWER AND PROTECTION INDICATOR

The protection red LED will light up and flash if there is a fault present in the amplifier. Please disconnect the amplifier and resolve the fault before reconnecting the amplifier.

The power indicator green LED will light up when the amplifier is working correctly.

# INTERFERENCE

---

All cables can create interference. The power cable and cinch / RCA audio cables are very prone to interference from other sources, while remote cables are less prone. Interference is often caused by the generator, ignition, or any other electronic parts or systems. Most of these problems can be eliminated by correct and careful wiring during setup. Here are some guidelines to follow.

- Use only a shielded audio cable for the wiring between the low level input of the amplifier and the RCA or DIN output of the radio.
- Lay the signal, speaker and power cables separately with enough distance from one another and also from each other car cable. If not possible, you can lay the circuit and ground cable together with the serial cables. Audio and speaker cable should be as far away from these as possible. The REM cable to the automatic antenna output of the radio can be laid together with the signal cables.
- Avoid ground loops by laying the ground wiring of all components towards a central point in a star layout. You can locate the best point by measuring the voltage directly at the battery, and comparing the voltage value with the chosen ground point and the positive terminal of the amplifier. If the measured voltage is only slightly different, you've found the correct central location. Otherwise please look for another point. You should measure with the ignition point for earth switched on.
- If there are pickups from external electrical sources into the speaker cables, divide the core leads and twist them together.
- If there are noises from the car electrics, add an interference suppression choke into the power wiring.
- If there are humming noises, use thicker ground cables or add further ground cables to the chassis.
- To reduce contact resistance and bad and loose contacts, please solder the cable ends or use multi core cable ends, spade terminals or others. Gold Plated spade terminal are free of corrosion and have the lowest contact resistance.
- Should all these measures not bring about any success, the use of a ground loop isolator may solve the problem.

# TROUBLESHOOTING

If you experience operation or performance problems with this product, compare your installation with the electrical wiring diagram on the previous pages. If problems persist, read the following troubleshooting tips which may help eliminate the problems.

SYMPTOM	POSSIBLE CAUSE	ACTION TO TAKE
NO OUTPUT	• Low or no remote turn-on input	• Check remote turn-on voltage output at amplifier and correct as needed
	• Fuse blown	• Check power wire integrity and reversed polarity, repair as needed and replace fuse
	• Power wires not connected	• Check power wire and ground connections and repair or replace as needed
	• Audio input not connected or no output from source	• Check input connections and signal integrity, repair or replace as needed
	• Speaker wires not connected	• Check speaker wires and repair or replace as needed
AUDIO CYCLES ON AND OFF	• Speaker are blown	• Check system with known working speaker and repair or replace speaker as needed
	• Thermal protection engages when amplifier heat sink temperature exceeds 90°C	• Make sure there is proper ventilation for amplifier and improve ventilation as needed
	• Loose or poor audio input	• Check input connections and repair or replace as needed
DISTORTED OUTPUT	• Amplifier level sensitivity set too high; exceeding maximum output capability of amplifier	• Reset gain referring to the turning section of the manual for detailed instructions
	• Impedance load to amplifier too low	• Check speaker impedance load, if below 2Ω stereo or 4Ω mono rewire speakers to achieve a higher impedance
	• Shorted speaker wires	• Check speaker wire connections and repair or replace as needed
	• Speaker not connected to amplifier properly	• Check speaker wiring and repair or replace as needed refer to the installation section of this manual for detailed instructions
	• Internal crossover not set properly for speaker	• Reset crossovers referring to the multi-cross crossover configuration section of this manual
DISTORTED OUTPUT (CONT'D)	• Speaker are blown	• Check system with known working speaker and repair or replace as needed
POOR BASS RESPONSE	• Speaker wired wrong polarity causing cancellation at low frequencies	• Check speaker polarity and repair as needed Reset crossovers referring to the multi-cross
	• Crossover set incorrectly	• Crossover configuration section of this manual for detailed instructions
DISTORTED OUTPUT (CONT'D)	• Impedance load to amplifier too low	• Check speaker impedance load, if below 2Ω stereo or 4Ω mono rewire speaker to achieve a higher impedance
	• Short in power wire or incorrect power connections	• Check power and ground connections and repair as needed
	• Fuse used is smaller than recommended	• Replace with proper fuse size
	• Too much current being drawn	• Check speaker impedance load, if below 2Ω stereo or 4Ω mono rewire speaker to achieve a higher impedance
	• Short in power wire of incorrect	• Check power and ground connections and repair as needed



SCAN OUR QR CODE OR VISIT [WWW.NAKAMICHICARAUDIO.COM](http://WWW.NAKAMICHICARAUDIO.COM)  
FOR COMPLETE AUDIO SETTINGS INSTRUCTIONS

 [nakamichi.global](https://www.facebook.com/nakamichi.global)  [nakamichi.caraudio](https://www.instagram.com/nakamichi.caraudio)

Made in China