



NBF25.0A

User Manual



10" FULL ALUMINUM ACTIVE SUBWOOFER

PANEL CONTROLS AND FEATURES

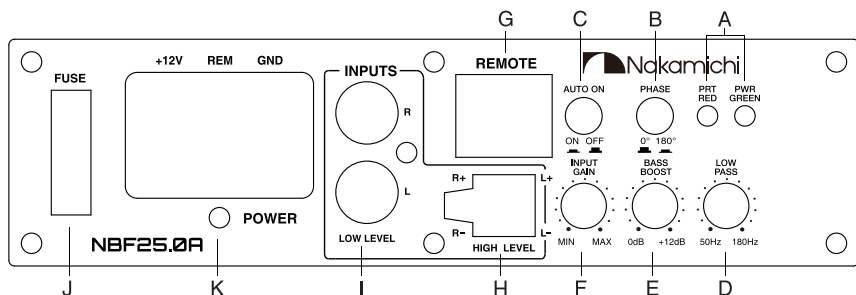

A. POWER STATUS LED

This bi-color LED glows green when power is on and no problems are present. If one of the protection circuits comes on, it will change to red.

B. PHASE SHIFT

Use this switch to help compensate for time alignment problems in the system. Such problems usually result from having the subwoofer at a different distance from the listener than the other speakers in the system.

C. AUTO POWER ON

The AUTO POWER ON (ON/OFF) is for high level (speaker-level) connections. When the switch is in the "ON" position, the subwoofer will AUTO POWER ON when there is signal input. If the amplifier detected no signal input, the amplifier will auto turn off. If you prefer to use the remote turn on/off connection, the switch is in the OFF position.

Note: Please connect the remote terminal to the remote output of head unit as Fig.4 when you hear the unit turn ON/OFF POP noise from the subwoofer.

D. LOW PASS FILTER

This control permits you to define the frequency range you want the subwoofer amplifier to receive. The subwoofer will reproduce all sound below the frequency you set.

Note: The low pass filter frequency can be higher or lower than the standard. There have +/-20% tolerance.

E. BASS BOOST

The BASS BOOST feature will increase the sound level in the bass frequencies.

F. INPUT GAIN CONTROL

After you have installed your system, turn this control to minimum.

Turn the head unit on (and the subwoofer will turn on via the remote connection). Turn the head unit volume to about 2/3 full level. Slowly turn up the subwoofer input gain control until you hear a small amount of distortion. Then reduce the level until the distortion is completely gone. Level the control at this setting.

G. REMOTE LEVEL CONTROL PORT

Attach the included remote level control to control the volume level of the subwoofer independently.

H. HIGH LEVEL (SPEAKER LEVEL) INPUTS

If your head unit does not have RCA outputs you can use the speaker outputs for the audio source for the subwoofer. Use the supplied cable and wire harness and connect the outputs properly as shown in the connection diagram in this manual.

I. LOW LEVEL RCA INPUTS

Low level inputs are the recommended way to introduce the audio signal to the subwoofer if RCA outputs are present on your head unit or other signal source (such as a sound processor).

J. FUSE

Do not use a fuse with a different value and never replace the fuse with a wire or coin.

K. POWER INPUT TERMINAL

WIRING

LOW LEVEL INPUT WIRING

Low-level (RCA) input wiring is preferred for best audio performance. Most trunk and under-seat installations will require a 6-12 feet RCA cable. Always use a high quality cable.

NOTE: Do not connect BOTH the high level and low level inputs from your receiver to your amplifier at the same time!

Fig.1

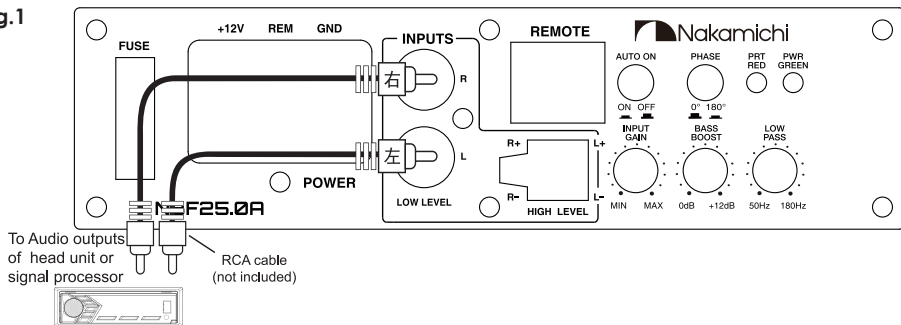

HIGH LEVEL INPUT WIRING

The high level input(s) should only be used when your receiver lacks RCA outputs. If the RCA outputs are not present, connect the speaker outputs from the receiver to the high level input connector of the amplifier. Be sure to observe polarity to avoid audio phase problems.

NOTE: Do not connect BOTH the high level and low level inputs from your receiver to your amplifier at the same time!

Fig.2

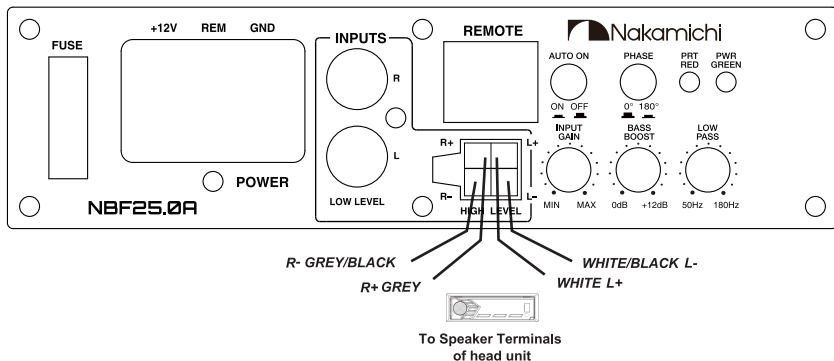

POWER CONNECTIONS

Connect the ground terminal to the closest point on the chassis of the vehicle. Use 8 gauge (or heavier) wire to connect the ground cable.

Connect the remote terminal to the remote output of head unit using 16 gauge (or heavier) wire.

Connect an empty fuse holder within 16" (40 cm) of the car battery, and run 8 gauge (or heavier) cable from this fuse to the amplifier location. Then connect the fuse holder to the "BATT+" (+12V) connection on the subwoofer rear panel.

WIRING

Fig.3

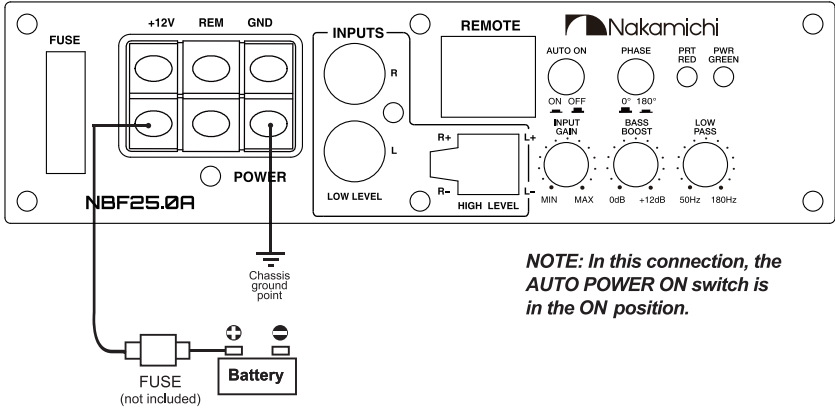
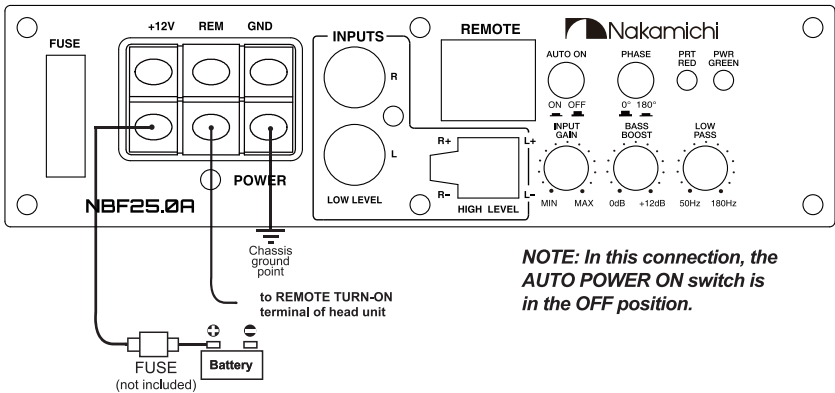
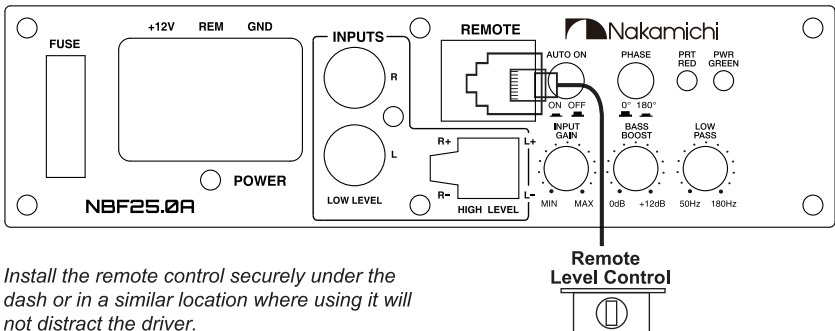

Fig.4



REMOTE LEVEL CONTROL CONNECTION

Fig.5



ACCESSORY LIST

1. User Manual	1pc
2. Mounting Screw Bag (Ø4x25mm x 4pcs, Ø3x14mm x 2pcs, Ø4x6mm x 8pcs)	1pc
3. Input Cable	1pc
4. Remote Control	1pc
5. Remote Cable	1pc
6. Mounting Bracket	4pcs

SPECIFICATIONS

N-power	150W	Low pass filter	50Hz - 180Hz
Max power	1000W	Bass Boost	0 - 12dB
THD	<0.5%	Subsonic Fiter	20Hz (Fixed)
Signal-to-noise ratio	>90dB	Fuse rating	25A
Frequency response	20Hz - 180Hz	Subwoofer	10" , 4 Ω
Input sensitivity,high level	1.0V	Dimensions (L x W x H) mm	300 x 225 x 72mm
Input sensitivity,low level	300mV		

TROUBLESHOOTING

If you experience operation or performance problems with this product, compare your installation with the electrical wiring diagram on the previous pages. If problems persist, read the following troubleshooting tips which may help eliminate the problems.

SYMPTOM	POSSIBLE REMEDY
Products will not power up	<p>Check to make sure you have a good ground connection.</p> <p>Check that the Remote Input (Turn-on) has at least 5V DC.</p> <p>Check that there is battery power on the (+) terminal.</p> <p>Check that there is at least 12V.</p> <p>Check all fuse, replace if necessary.</p> <p>Make sure that the Protection LED is not illuminated. If it is lit shut off the amplifier briefly, and then repower it.</p>
Protection LED comes on when amplifier is powered up	<p>Turn down the volume control on the head unit to prevent overdriving.</p> <p>Check that there is good air circulation around the amp.</p>
No output	<p>Check that all fuses are OK.</p> <p>Check that unit is properly grounded,</p> <p>Check that the Remote Input (Turn-on) has at least 5V DC.</p> <p>Check that the RCA audio cables are plugged into the proper inputs.</p>
Low output	<p>Reset the Level Control.</p> <p>Check the Crossover Control settings.</p>
High hiss in the sound.	<p>Disconnect all RCA inputs to the power sub's control panel. If the hiss disappears, then plug in the component driving the amplifier and unplug its inputs. If the hiss disappears at this point, go on until the faulty/noisy component is found.</p> <p>It is best to set the amplifie's input level control as low as possible. The best subjective signal-to-noise ratio is achieved in this manner. Try to set the head unit as high as possible (without distortion).</p>
Squealing noise is present.	<p>Check for improperly grounded RCA interconnects.</p>
Distorted sound.	<p>Check that the Input Level Control is set to match the signal level of the head unit.</p>
Engine noise (static type)	<p>This is usually caused by poor quality RCA cables, which can pick up radiated noise. Use only the best quality cables, and route them away from power cables.</p>
Engine noise (alternator whine)	<p>Check that the RCA grounds are not shorted to the vehicle chassis.</p> <p>Check that the head unit is properly grounded.</p>

面板控件和功能

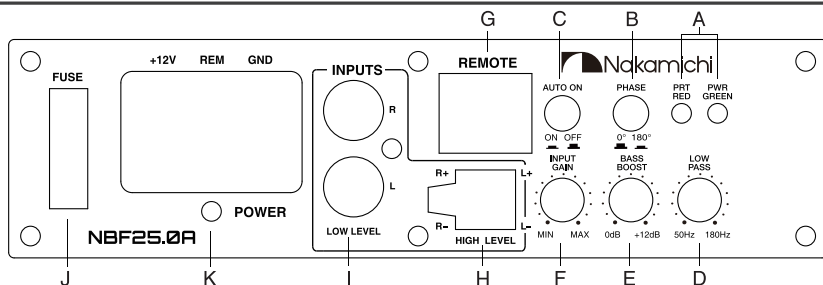

- A. 電源狀態指示燈
- B. 相位轉換開關
- C. 自動開關機控制開關

注意：開關主機時，如果聽到有關機衝聲響，此時自動開關機開關要設定在“OFF”位置。改用主機的REMOTE線來控制開關機。

- D. 低通濾波器電位器

注意：低通濾波器的實際頻率有可能高于或低于設定值，誤差在±20%左右

- E. 低音提升電位器
- F. 音量電位器
- G. 遠程低音音量控制端口
- H. 高電平輸入端口
- I. 低電平輸入端口
- J. 保險絲插座
- K. 電源輸入端子

低電平輸入連接方式

Fig.1

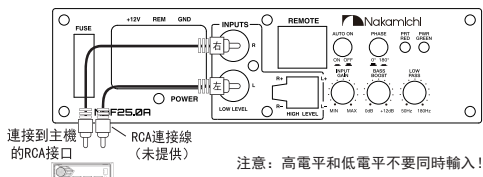

连接到主机的RCA接口
(未提供)

注意：高電平和低電平不要同時輸入！

高電平輸入連接方式

Fig.2

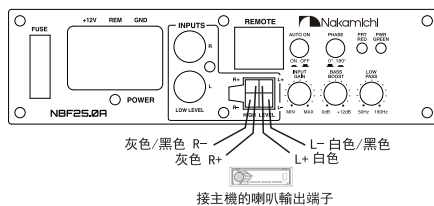

灰色/黑色 R-
灰色 R+
L- 白色/黑色
L+ 白色

接主机的喇叭輸出端子

電源輸入連接方式

方式一：

Fig.3

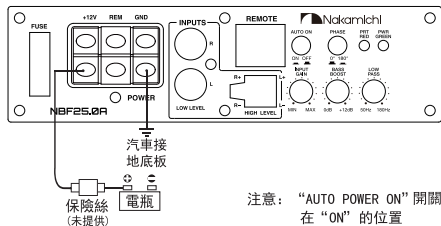

汽車接
地地板

保險絲
(未提供)

電瓶

注意：“AUTO POWER ON”開關在“ON”的位置

方式二：

Fig.4

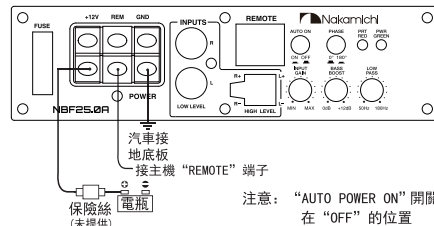

汽車接
地地板

保險絲
(未提供)

電瓶

注意：“AUTO POWER ON”開關在“OFF”的位置

遠程電平控制連接

Fig.5

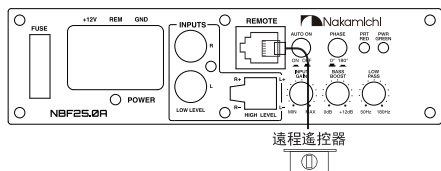

遠程遙控器

注意：遠程遙控器安裝在合適的位置（不能影響司機的駕駛安全）。

產品規格

額定功率	150W	低通濾波器	50Hz - 180Hz
最大功率	1000W	低音提升	0 - 12dB
總諧波失真	<0.5%	高通濾波器	20Hz (Fixed)
信噪比	>90dB	保險絲額定值	25 A
頻率響應	20Hz - 180Hz	主動低音喇叭，負載	10" , 4 Ω
高電平輸入靈敏度	1.0V	尺寸（長x寬x高）	300x 225 x 72mm
低電平輸入靈敏度	300mV		

故障排除

故障現象	故障原因
產品不能啟動	<ol style="list-style-type: none"> 1. 檢查功放電源地線是否連接良好。 2. 檢查電瓶正極電壓是否加在功放的電源端子正極。 3. 檢查REMOTE電壓不要低於5VDC。 4. 檢查電源端子正極電壓不要低於+12V。 5. 檢查保險絲是否損壞（開路）。 6. 確認保護指示燈是否亮起，如指示燈亮起則重新啟動功放。
產品啟動後保護指示燈亮起或過熱保護	<ol style="list-style-type: none"> 1. 調低音量電位器以防止過載保護。 2. 檢查濾波器電位器大小是否合適。
產品無輸出	<ol style="list-style-type: none"> 1. 重新設定音量電位器。 2. 檢查濾波器電位器是否在正確的位置。
播放音樂時有嘶嘶聲	<ol style="list-style-type: none"> 1. 斷開功放的信號輸入線，如果嘶嘶聲消失就是信號源有問題，此時要確認信號線是否連接良好，或信號線質量是否有問題，否則主機可能有問題。 2. 盡可能把功放音量電位器開小，同時盡可能把主機音量開大（不要失真）。
有嘯叫聲	<ol style="list-style-type: none"> 1. 檢查RCA的地線是否連接好。
失真	<ol style="list-style-type: none"> 1. 檢查功放音量電位器是否過大了，功放音量電位器要配合好主機音量。 2. 檢查濾波器電位器大小是否合適。
引擎聲（靜態）	<ol style="list-style-type: none"> 1. 主要是RCA信號線質量太差的原因，要換用質量好的RCA信號線，並要遠離電源線。
引擎聲（發電機火花聲）	<ol style="list-style-type: none"> 1. 檢查RCA信號線，其地線不能連接到汽車底盤。 2. 檢查主機是否正確接地。