



NA3605-M6

User Manual



6.75" 2-DIN AV RECEIVER

YOUR AV RECEIVER

Dear Customer,

Congratulations on purchasing our Nakamichi mobile system product for your sound system.

This product has been designed and manufactured to Nakamichi's exacting standards to ensure many years of audio enjoyment. For the best performance, we recommend that you have your Nakamichi product installed by an authorized Nakamichi dealer.

If you would like to install this product on your own, we recommend for you to go through this manual to familiarize yourself with all the installation requirements and procedures.

If you encounter any issues or if you have any questions on the operation of this product, please contact your nearest authorized Nakamichi dealer for assistance, or you may also contact us through our website or social media channels.

Installation of your Product

In today's modern vehicles, it is very easy to cause damage to existing systems through improper installation. Please follow and scrutinize all wiring diagrams to ensure that you have connected everything in its proper place.

If you find yourself uncomfortable or unfamiliar with understanding the wiring and installation diagrams or testing instructions, do contact your nearest Nakamichi dealer to perform the installation for you.

Safety Warnings and Considerations

- Clean only with a dry cloth or other similar materials.
- Install your product in a dry, well-ventilated location that does not interfere with your vehicle's safety equipment.
- Do not block any ventilation openings when installing this product.
- Do not mount the product in the engine compartment of your vehicle or in any areas of extreme heat such as mufflers, silencers, exhaust pipes or other heat producing apparatus.
- Securely mount the product so that it does not come loose in the event of a collision or as a result of repeated vibrations that might occur during normal operation.
- Installation of the apparatus must be done with great care to prevent damage to your vehicle's fuel lines, power, and other electrical wiring, hydraulic brake lines, and other systems. If possible, always visit your nearest Nakamichi dealer to perform the installation.
- Do not run any wiring outside or underneath the vehicle. Keep all wires inside the vehicle.

YOUR AV RECEIVER

Dear Customer,

Congratulations on purchasing our Nakamichi mobile system product for your sound system.

This product has been designed and manufactured to Nakamichi's exacting standards to ensure many years of audio enjoyment. For the best performance, we recommend that you have your Nakamichi product installed by an authorized Nakamichi dealer.

If you would like to install this product on your own, we recommend for you to go through this manual to familiarize yourself with all the installation requirements and procedures.

If you encounter any issues or if you have any questions on the operation of this product, please contact your nearest authorized Nakamichi dealer for assistance, or you may also contact us through our website or social media channels.

Installation of your Product

In today's modern vehicles, it is very easy to cause damage to existing systems through improper installation. Please follow and scrutinize all wiring diagrams to ensure that you have connected everything in its proper place.

If you find yourself uncomfortable or unfamiliar with understanding the wiring and installation diagrams or testing instructions, do contact your nearest Nakamichi dealer to perform the installation for you.

Safety Warnings and Considerations

- Clean only with a dry cloth or other similar materials.
- Install your product in a dry, well-ventilated location that does not interfere with your vehicle's safety equipment.
- Do not block any ventilation openings when installing this product.
- Do not mount the product in the engine compartment of your vehicle or in any areas of extreme heat such as mufflers, silencers, exhaust pipes or other heat producing apparatus.
- Securely mount the product so that it does not come loose in the event of a collision or as a result of repeated vibrations that might occur during normal operation.
- Installation of the apparatus must be done with great care to prevent damage to your vehicle's fuel lines, power, and other electrical wiring, hydraulic brake lines, and other systems. If possible, always visit your nearest Nakamichi dealer to perform the installation.
- Do not run any wiring outside or underneath the vehicle. Keep all wires inside the vehicle.

FCC NOTES

WARNING!

Changes or modifications to this unit not expressly approved by the party responsible for compliance could void the user's authority to operate the equipment.

NOTE:

This equipment has been tested and found to comply with the limits for a Class B digital device, pursuant to Part 15 of the FCC Rules. These limits are designed to provide reasonable protection against harmful interference in a residential installation.

This equipment generates, uses and can radiate radio frequency energy and, if not installed and used in accordance with the instructions, may cause harmful interference to radio communications.

However, there is no guarantee that interference will not occur in a particular installation. If this equipment does cause harmful interference to radio or television reception, which can be determined by turning the equipment off and on, the user is encouraged to try to correct the interference by one or more of the following measures:

- Reorient or relocate the receiving antenna.
- Increase the separation between the equipment and receiver.
- Connect the equipment into an outlet on a circuit different from that to which the receiver is connected.
- Consult the dealer or an experienced radio/ TV technician for help.

FCC ID:

This device complies with Part 15 of the FCC Rules. Operation is subject to the following two conditions: (1) This device may not cause harmful interference, and (2) This device must accept any interference received, including interference that may cause undesired operation.

SPECIFICATION

General

Operation Voltage: 14.4V(10.5-16V)
Installation Size: 178x152x100MM
Operation Temperature: -10°C - +70°C
Storage Temperature: -20°C - +80°C
Net Weight: 1.2kg

Radio Item

FM Frequency Range: 87.5-108.0MHZ
MW Frequency Range: 522-1620KHZ
Usable Sensitivity:
2U_V(FM) / 80U_A(MW)

Bluetooth Item

Communication System:
BT 2.1 Version+EDR
Output: BT Standard Power 2 Class
Max Communication Range: 5m
Frequency Band: 2.4GHZ
Compatible Bluetooth Protocol:
HFP/ HSP/ A2DP/ AVRCP

USB Item

USB Standard: USB2.0 High Speed
File System: FAT 16/32
Max Current: DC 5V-1A/D/A
Converter: 24BIT
Audio/Video Decoder:
MPEG1/ PEG2/ MP4/ RMVB/ MP3/ WMA/ JPEG

TFT Screen Item

Size: 6.75 inch
Resolution: 800x480 RGB
Contrast ratio: 500

Video Item

External Video Input System:
NTSC/PAL/SECAM
External Video Input: 1VP-P/75Ω

Audio Item

Max Power: 4X50W
Pre-output(V): 4V/10KΩ
Pre-output impedance: ≤600Ω
Speakers impedance: 4-8Ω
External audio input:
600MV/10KΩ(<1%THD)

Note:

Specification and design; functions and features; unit illumination; colour and display segment are subject to change without prior notice. Photos and drawings on gift box or operation manual might be varied from the exact unit. Depends on the input devices operation might be varied from the operation manual described

WIRING CONNECTION

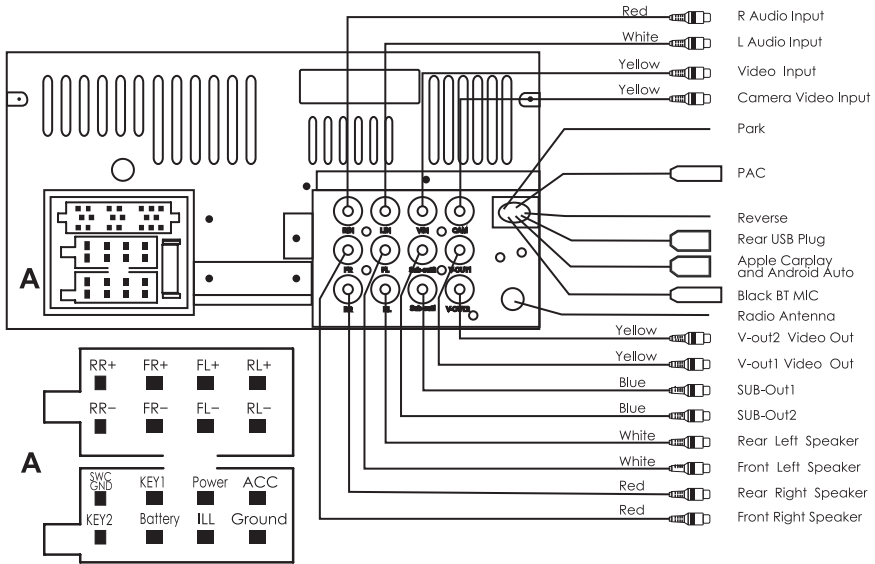

ACCESSORY LIST

1. AV Receiver	1 pc	6. Installation Brackets	1 pc
2. Frame	1 pc	7. Screws	2 pcs
3. Half Sleeve	1 pc	8. Disassembly Keys	8 pcs
4. Remote	1 pc	9. User Manual	2 pcs
5. ISO Male Connector	2 pcs		

PRECAUTIONS ON POWER SUPPLY AND SPEAKER CONNECTIONS:

- Do not connect the speaker leads of the power cord to the car battery otherwise, the unit will be seriously damaged.
- BEFORE connecting the speaker leads of the power cord to the speakers, check the speaker wiring in your car.

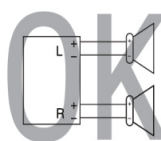
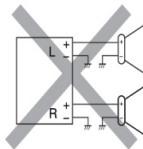
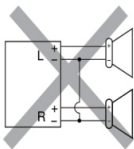

FRONT PANEL



FUNCTION

1. Power
2. Volume +
3. Volume -
4. Home
5. Voice Recognition

OPERATIONS & CONTROLS

- Short press to mute/cancel mute.
Long press to enter/quit standby mode.
- Short press to increase volume.
- Short press to decrease volume.
- Press to enter main menu.
- Press to active Siri. (If Available)

REMOTE CONTROL







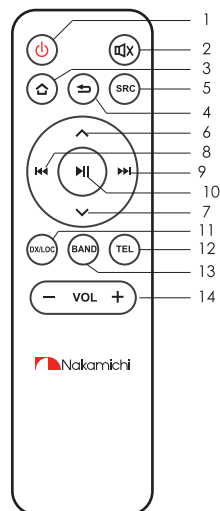



Battery Replacement

Refer to the back of remote handset for details on how to replace the battery. Replace the battery only with the same or equivalent type.

Note: If the remote handset will not be used for a long time, please remove the battery from the battery compartment.



REMOTE CONTROL

<u>NO.</u>	<u>SYMBOL</u>	<u>OPERATION & CONTROL MODES</u>
1		Short Press: Power On/ Off
2		Short Press: Mute/ Unmute
3		Short Press: Return to home page
4		Short Press: Return to the last used interface
5	SRC	Short Press: Switch the source module
6		Short Press: Radio - Manual tuning (forward)
7		Short Press: Radio - Manual tuning (reverse)
8		Short Press: Radio - Switch to the previous preset USB/SD/Bluetooth - Previous track Long Press: Radio - Automatic seek (reverse) USB/SD/Bluetooth - Fast reverse
9		Short Press: Radio - Switch to the next preset USB/SD/Bluetooth - next track Long Press: Radio - Automatic seek (forward) USB/SD/Bluetooth - Fast forward
10		Short Press: USB/SD/Bluetooth - Play or Pause
11	DX/LOC	Short Press: Radio Switch between long range DX or short range LOC
12	BAND	Short Press: Radio - Switch between FM and AM bands
13	TEL	Short Press: Enter the Bluetooth interface.Call back function
14		Short Press: Reduce volume
15		Short Press: Increase volume

FUNCTIONS APPLICATION

Main menu

(Please refer to the actual menu display for reference.)
The first time power on, unit will be default into languages setting interface, select the needed country and language, press “√” enter to main menu, functions are as below:



Radio: Shows the Radio interface.



Phone: Shows the Bluetooth connection interface.



Setting: Shows the Settings interface.



USB: Shows the USB playback interface for compatible files.



BT Music: Shows the music playback interface.



AUX: Shows the AUX interface.

Android Auto/CarPlay:

Shows the relevant interface based on your connected device.

Screen off:

Turns off the screen, to reactivate the screen simply press any part of the screen.

Radio Settings

Touch “Radio” in main menu to enter radio interface.

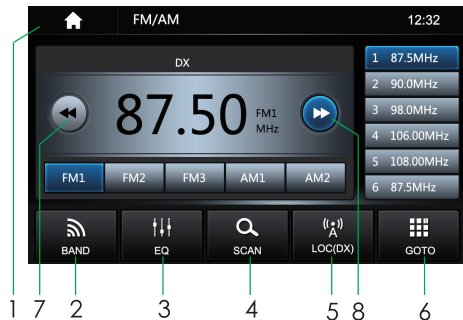

FUNCTIONS APPLICATION



1. **MAIN MENU:** To return to the main menu



2. **BAND:** Switch between FM1/FM2/FM3/AM1/AM2



3. **EQ:** Enter the EQ settings interface



4. **SCAN:** Scans for available stations, long press to automatically search and save stations with the strongest signals into the presets.



5. **LOC:** Turns the LOC function on/off



6. **GOTO:** Shows the Radio tuning input interface, input the frequency directly or selected preset stations to start playing.



7. Scans for stations in reverse.
Long press to search for stations automatically.



8. Scans for stations.
Long press to search for stations automatically.

RDS Function

RDS will allow you to display information such as traffic status, radio station name and more. The unit can automatically switch to the strongest station based on the similar program.

AF: Turn on/off AF mode.

TA: Turn on/off TA mode.

PTY: Shows program types, and allows you to search for stations according to different programs.

Phone

This unit allows for hands free calling, using your phone's Bluetooth connection to the unit, you'll be able to dial, answer, access phone book and playback music.



Keyboard: Dial

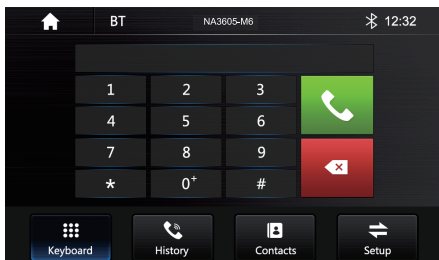

History: Calls record



Contacts: Phone book



Setup

FUNCTIONS APPLICATION

Pair/Connect

Connect your phone to the unit using the below steps.

1. Access the Bluetooth connection interface in yourphone.
2. Search for Bluetooth devices from either the unit or phone.
3. Once connected successfully, the will be a prompt for the password. Input "0000" to confirm the connection.

Dial

Once the phone and unit are connected successfully, you'll be able to make calls from the unit.



Touch it to make a call.



Touch it to delete numbers one by one, long press to delete all inputted numbers.



Touch it to show the numbers keyboard, touch again to exit.



Touch it to hang up the call.



Touch it to switch call audio to earphone/AV receiver.



Touch to mute.

Note: You can also manage calls through your phone.

Calling Record

Check for dialed/ answered/ missed calls history. Touch  icon to enter calling record interface:

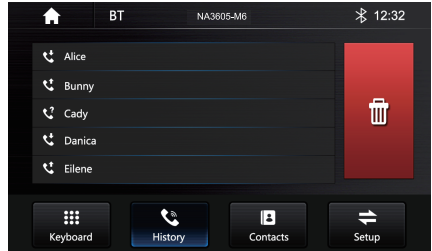

Delete dialed calls.

Phone Book

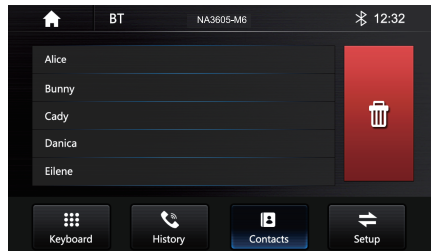

When your phone and unit are paired, the unit can automatically reach contacts from your phone and store them within the unit. (selected phones only)



Delete Contacts.

FUNCTIONS APPLICATION

External Play Device

When you connect a compatible data device to your unit, the following interface will appear.

Music

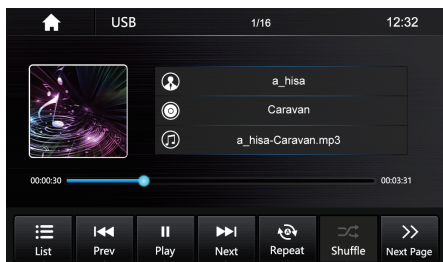

1 2 3 4 5 6 7

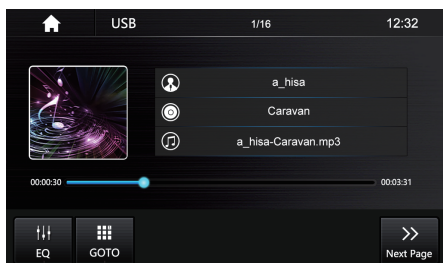

8 9

1. USB List Menu
2. Play previous song/media
3. Play/pause current song/media
4. Please next song/media
5. Repeat mode:
Repeat all - Repeat off - Repeat single
6. Random playback on/off
7. Next page
8. EQ settings
9. Numbers selection playback

Video

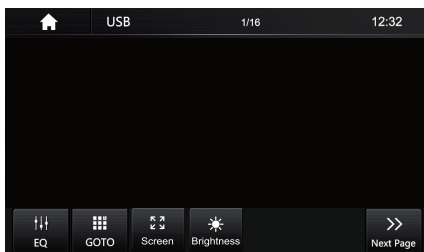

10 11

10. Can adjust the screen ratio
11. You can adjust brightness, contrast, hue, saturation

Picture

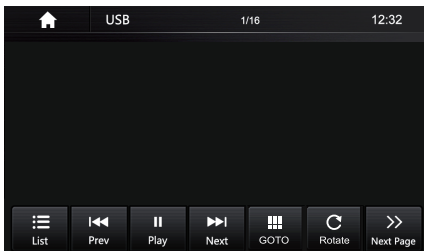

1 2 3 4 5 6 7

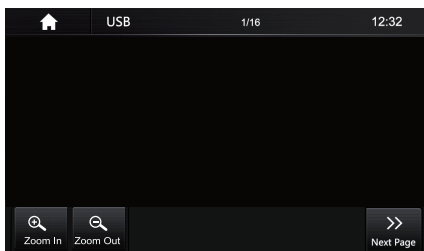

8 9

1. USB List Menu
2. Play previous picture
3. Play/pause current picture
4. Please next picture

FUNCTIONS APPLICATION

- 5. Numbers selection playback
- 6. Click the icon to rotate the picture 90 degrees
- 7. Next page
- 8. Zoom in a picture
- 9. Zoom out a picture

BT Music

Touch  to enter BT music interface. EQ is the same as sound settings EQ menu.

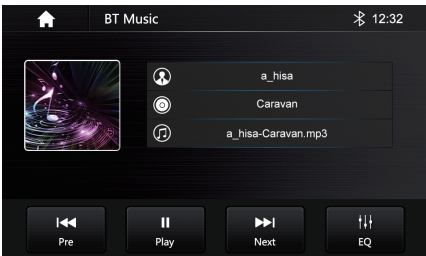

Lossless files playback supported. FLAC/ WAV/ APE file formats.

AUX

Insert video input connector to input video's input jack, audio input conencto to input audio's input jack, touch "AUX" icon from main menu to enter the AUX interface.



Settings Operation

Touch "Setting" icon from main menu to enter the settings interface.



Time Setting

Touch "time" to enter time setting up/ down sliding can set year/ month/ date/ hour/ minute/ time system.

Sound Setting

Touch "Sound Setting" to enter sound setting interface:

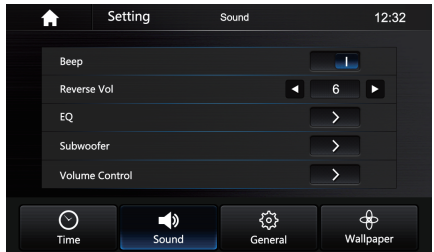

In sound setting menu, you can turn on/off keyboard sound/reverse sound/EQ.

FUNCTIONS APPLICATION

EQ:

Touch EQ icon to enter below menu:

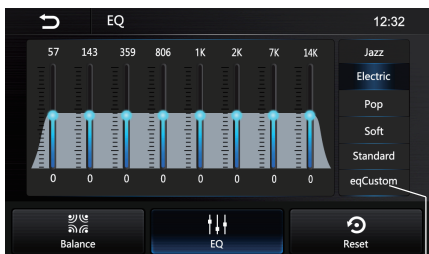
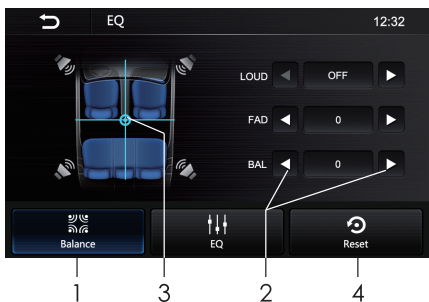

1. Enter sound focus control function.
2. Fine adjustment
3. Fast set sound focus's control point.
4. Reset to default settings.
5. Up/down slide to switch EQ modes: rock/classical/jazz/etc.

General Setting

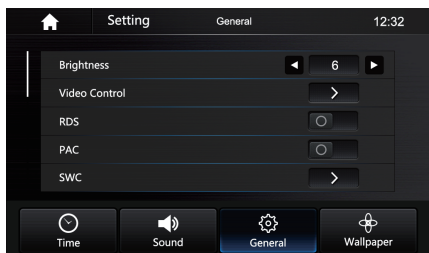

Touch **O** to set relevant functions on/off . More items can be accessed by sliding the menu.

Brightness: Left and right slide icon to adjust screen's brightness.

SWC: Touch "SWC" icon to enter the steering wheel control menu.

Radio Area: Choose the required. radio region.

Serial/Version: Touch [Serial&Version] icon to enter serial number and version number interface, to check the needed information.

(Please refer to the actual unit display)

Language: Touch [Language] icon to enter language setting interface, select the required language.

Reset Factory Data

Once selected, the unit will prompt to confirm reset to factory settings. Once confirmed the system will automatically reboot. All data will be lost and any third party programs will be lost. Please backup your data before performing this function.

MIC Switch: Touch F/R icon to change front or rear mic.

Driver Position: Set function for driving Position.

Drive Forbidden Watch Video: Click icon to turn ON/OFF the Drive-forbidden-Watch Video.

FUNCTIONS APPLICATION

Seven Colour Light:

Touch icon to enter Seven Colour Light menu.

Wallpapers Setting

Choose the required wallpaper, touch "wallpaper setting" icon to enter the setting interface.

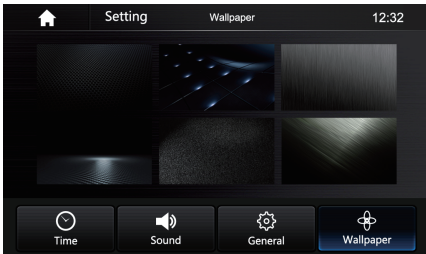

Connect iPhone to the unit to enter the CarPlay interface.

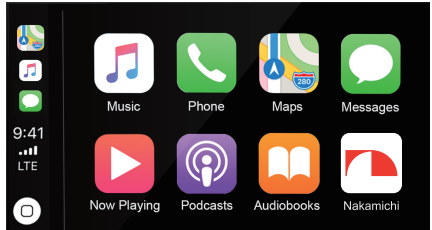

The unit can be used to make calls, play music, view maps, check traffic information, return to the unit's main interface, listen to Podcasts, read Audiobooks and so on.

Android Auto/CarPlay

Connect Phone to the unit to enter the Android Auto interface.

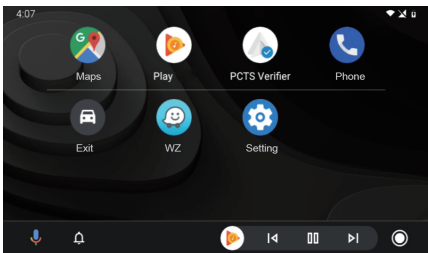

The unit can be used to call, play music, view maps, check traffic information, watch videos, return to the unit's main interface, listen to Podcasts, read Audiobooks and so on.

COMMON TROUBLE-SHOOTING

Problem	Cause	Correct action
Can not power on	Check fuse	Change fuse same as the old one
	Some factors cause MPU wrong operation	Press RES button on the panel by penpoint, then, power on
After ignition switch off, setting information all lose	Change battery or fuse	Reset information and save
Poor performance of radio station	Weak signal	Move the car to another place, then research
Can not switch language/subtitle	There is only one language/ subtitle in disc	If disc is not with multilanguage/ subtitle, it cannot switch language/ subtitle
No image	Other factors cause MPU wrong operation	Press RES button on the panel by penpoint, then, power on
Can not watch image during driving	It's not allowed to watch image during driving	Park the car in a safe place, put the car stall in "P" position, pull up the hand brake, parking brake wire must be grounded.



SCAN OUR QR CODE OR VISIT WWW.NAKAMICHICARAUDIO.COM
FOR COMPLETE AUDIO SETTINGS INSTRUCTIONS

 nakamichi.global  nakamichi.caraudio

Made in China | 中国制造