

Dimmer Switch for LED/Compact Fluorescent/Incandescent

Single Pole (One Location) or 3-Way (Two Locations)

LED/CFL 150W, Incandescent 600W 120VAC, 60HZ

Model Number: USP3-DS01

USER MANUAL

WARNINGS AND CAUTIONS

1. Use with compatible dimmable LED, CFL bulbs, Incandescent or 120V halogen fixtures only. To avoid overheating and possible damage to this device and other equipment, DO NOT install to control a receptacle, a motor-operated or a transformer-supplied appliance, or any other lighting sources than those specified.
2. To be installed and/or used in accordance with appropriate electrical codes and regulations.
3. Use only one (1) dimmer in a 3-way circuit.

BESTTEN®

Power for Today, Ideas for Tomorrow

4. When multiple bulbs are used with one dimmer, do not mix bulb types. All bulbs should be either LED, CFL or incandescent. Using the same make/model of each bulb will enhance dimmer performance.
5. Use this device with copper or copper clad wire only.
6. Clean dimmer with a soft damp cloth only. Do not use any chemical cleaners.
7. If you are unsure about any part of these instructions, consult an electrician.

SPECIFICATIONS

Voltage 120V, 60Hz
Dimmable LED/CFL..... Max. 150W
Incandescent/Halogen..... Max. 600W
Switch Type..... Single Pole/3-Way
Operation Temperature..... 32°F (0°C)---104°F (40°C)
Certifications..... UL/cUL Listed

INSTALLATION

Multi-Gang Installations:

When installing more than one control in the same wall box, it may be necessary to remove all the inner side sections prior to wiring. Using pliers, bend each needed side section up and down until it breaks off.

Dimmer Capacity:

600W unmodified
500W if one side is removed
400W if both sides are removed

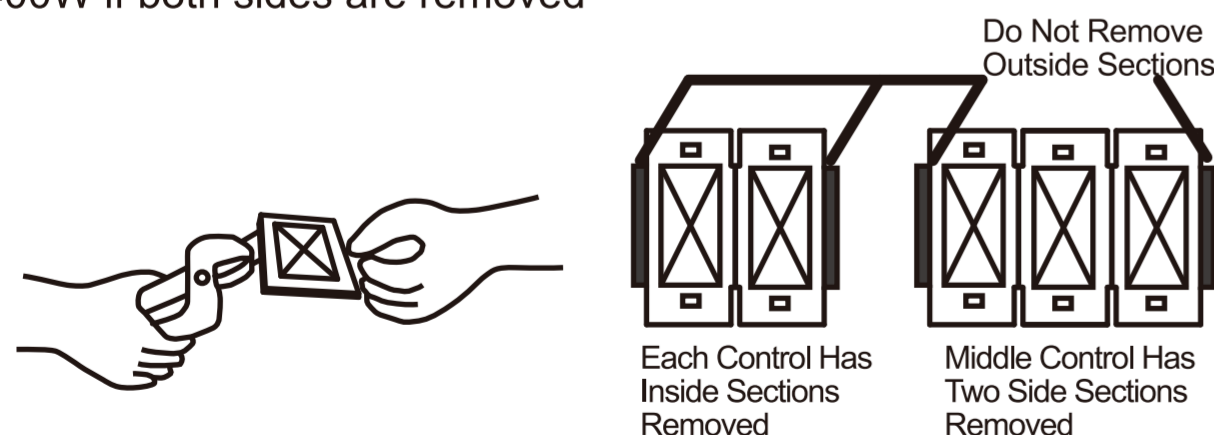

STEP 1 Turn OFF Power :

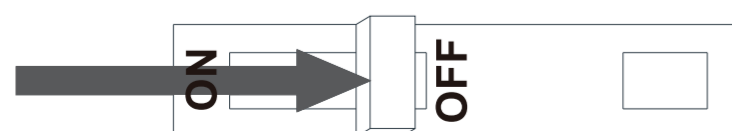

STEP 2 Identify Your Wiring Application (most common):

NOTE: If the wiring in the wall box does not resemble any of these configurations, consult an electrician.

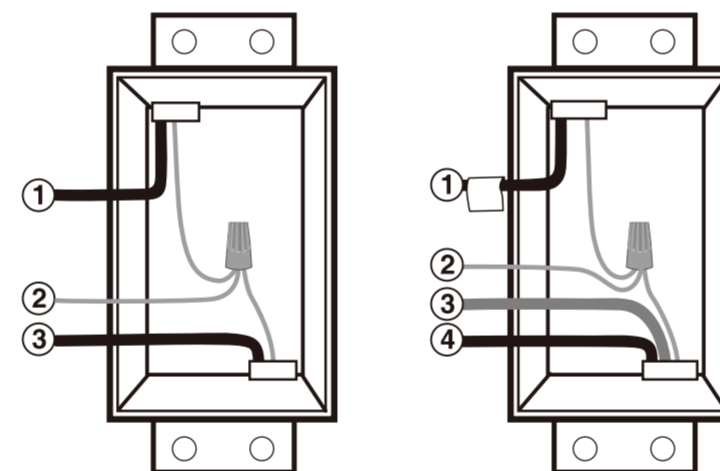

Single-Pole

1. Line (Hot)
2. Ground
3. Load

3-Way

1. Line or Load Common (See important instructions below)
2. Ground
3. First Traveler
4. Second Traveler

IMPORTANT: For 3-way applications, note that one of the screw terminals from the old switch being removed will usually be a different color (Black) or labeled Common. Tag that wire with electrical tape and identify it as the common (Line or Load) in both the dimmer wall box and the standard 3-way switch wall box. The remaining two wires on the brass or lighter screw terminals of the old switch are the travelers.

STEP 3 Prepare Wires:

- Pull off the pre-cut insulation from the Dimmer wires.
- Make sure that the ends of the wires from the wall box are **straight (cut if necessary)**.

STEP 4A Single-Pole Wiring Application:

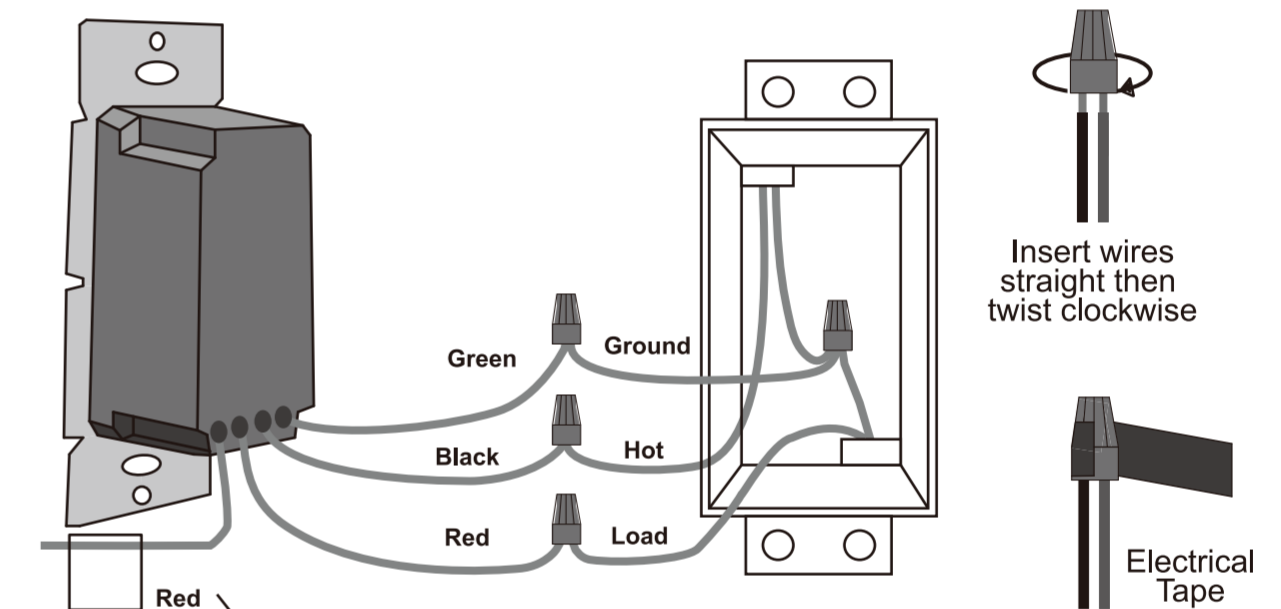

This wire is used in 3-way installations only. For single pole installations, do not remove this insulating label.

Connect wires as follows:

Screw wire nuts on clockwise making sure no bare conductors show below the wire connectors. Secure each connector with electrical tape.

1. Green dimmer wire connects to Ground or bare copper wire.
2. Black dimmer wire connects to Line Hot wire.
3. Red dimmer wire without insulating label connects to Load wire.
4. Remaining red dimmer wire should have an insulation label affixed. **DO NOT REMOVE** it in a single pole application.

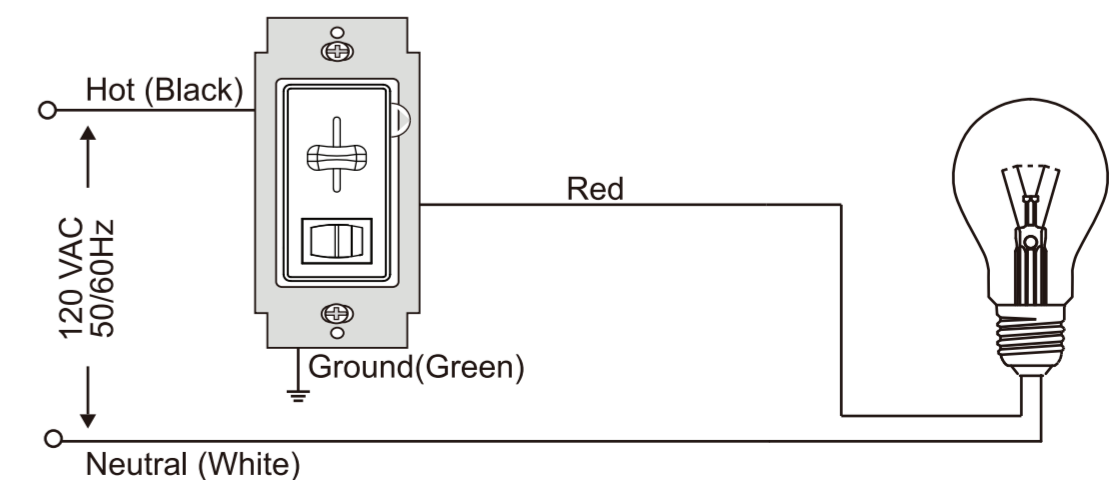

STEP 4B 3-Way Wiring Application:

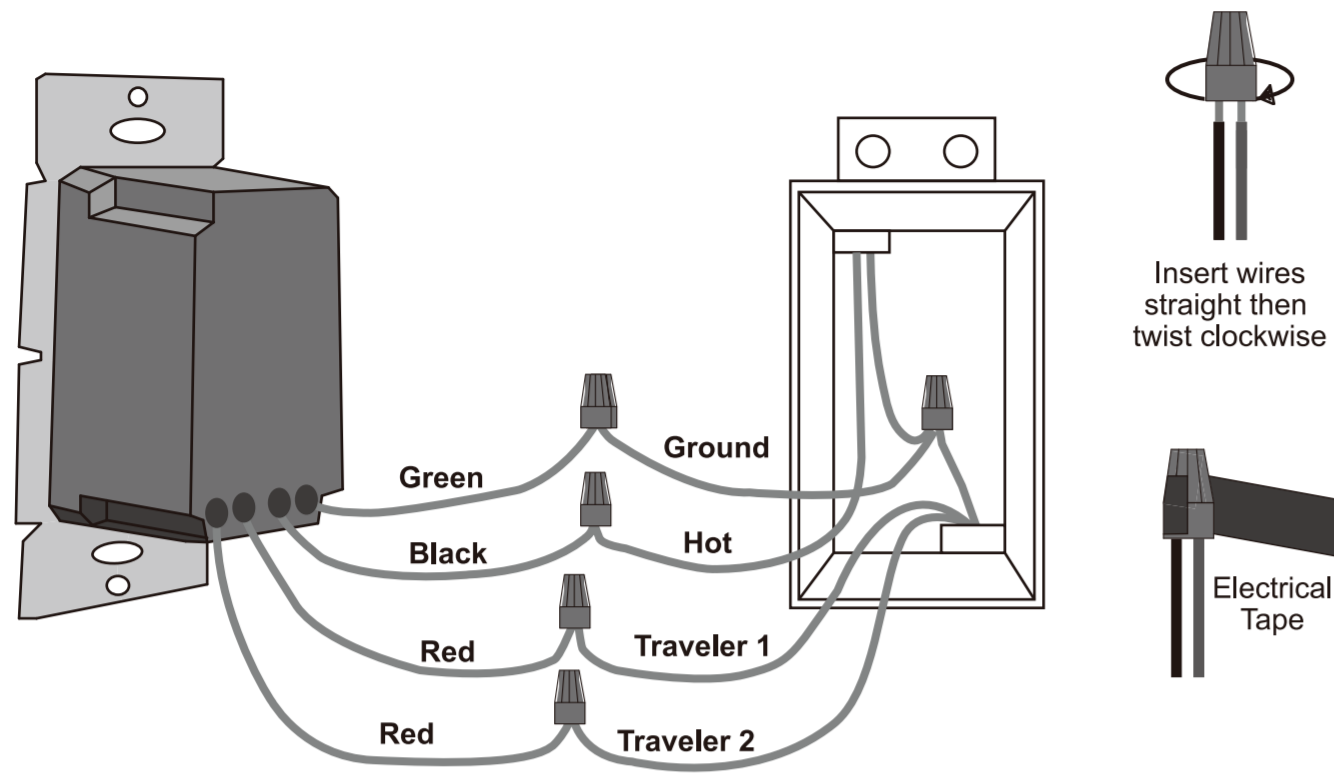

Connect wires as follows:

Screw wire nuts on clockwise making sure no bare conductors show below the wire connectors. Secure each connector with electrical tape.

1. Green dimmer wire connects to Ground or bare copper wire.
2. Black dimmer wire connects to Line Hot or Load (Common) wire.
3. Two Red dimmer wires connects to the two travelers.

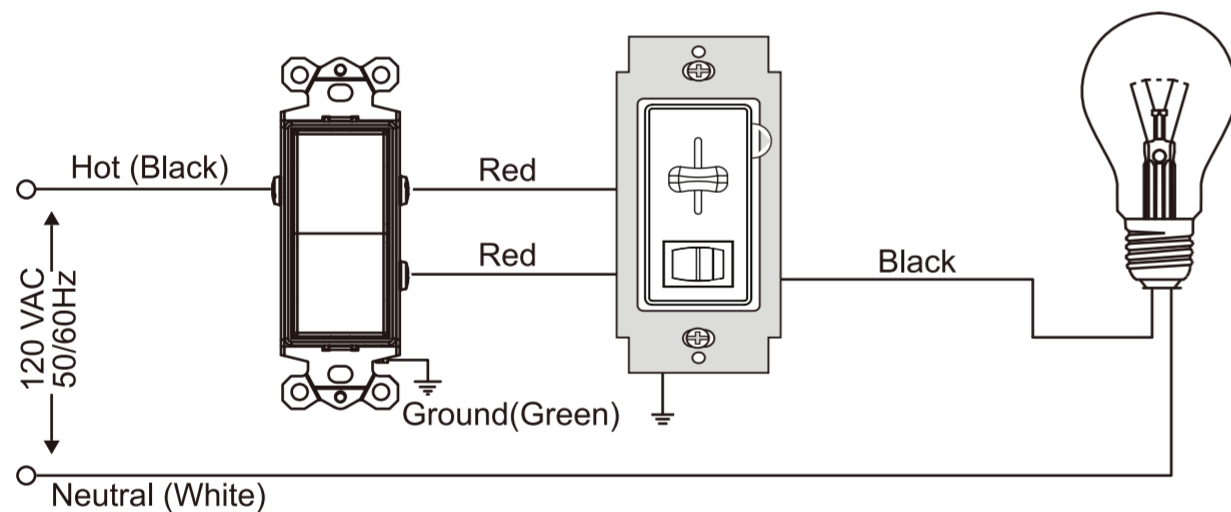

STEP 5 Dimmer Mounting:

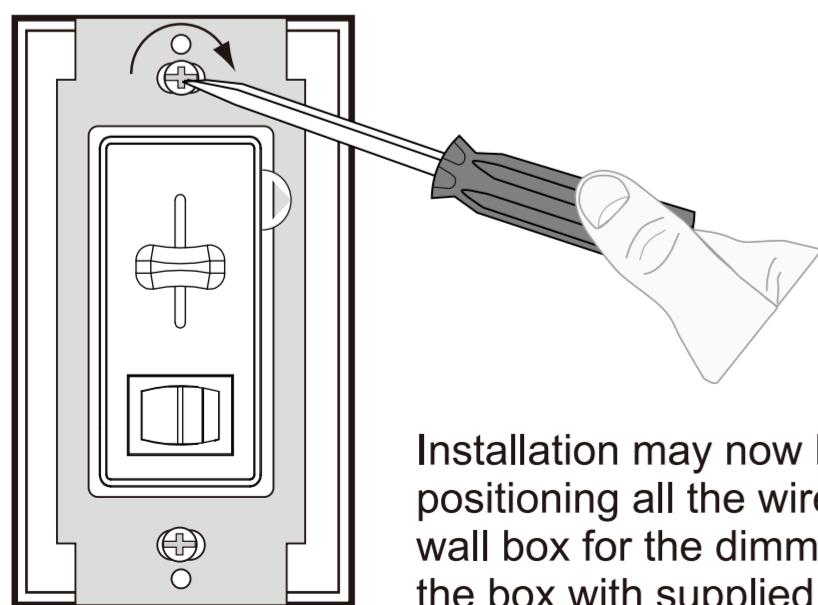

Installation may now be completed by carefully positioning all the wires to provide room in the wall box for the dimmer. Mount the dimmer into the box with supplied mounting screws.

STEP 6 Turn ON Power:

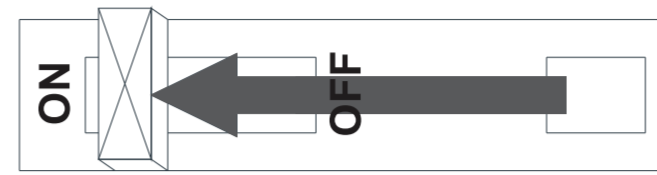

STEP 7 Test Dimmer:

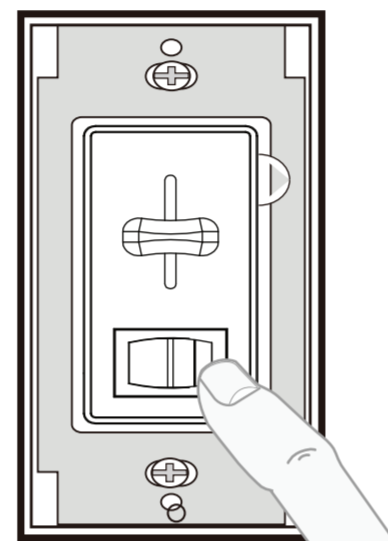

ON/OFF:

Press rocker switch to ON/OFF position
Lights will turn ON/OFF

BRIGHTEN & DIM:

Move the slider control lever
Lights will BRIGHTEN or DIM

If the LEDs flicker, go to step 8 to adjust dimmer range.

If the LEDs work properly, install the wallplate and complete the installation.

STEP 8 Adjust Dimmer Range (optional):

Adjust circuit dimming as follows:

1. Turn on the Switch and move the Slider to the lowest (bottom) setting.
2. Rotate (Counter-Clockwise) the Sensitivity Dial all the way up.

- NOTE:** If the dial stops in either direction, do not continue to turn it.
3. Rotate (Clockwise) the Sensitivity Dial down slowly until the preferred lowest light level is achieved and the light is not flickering.

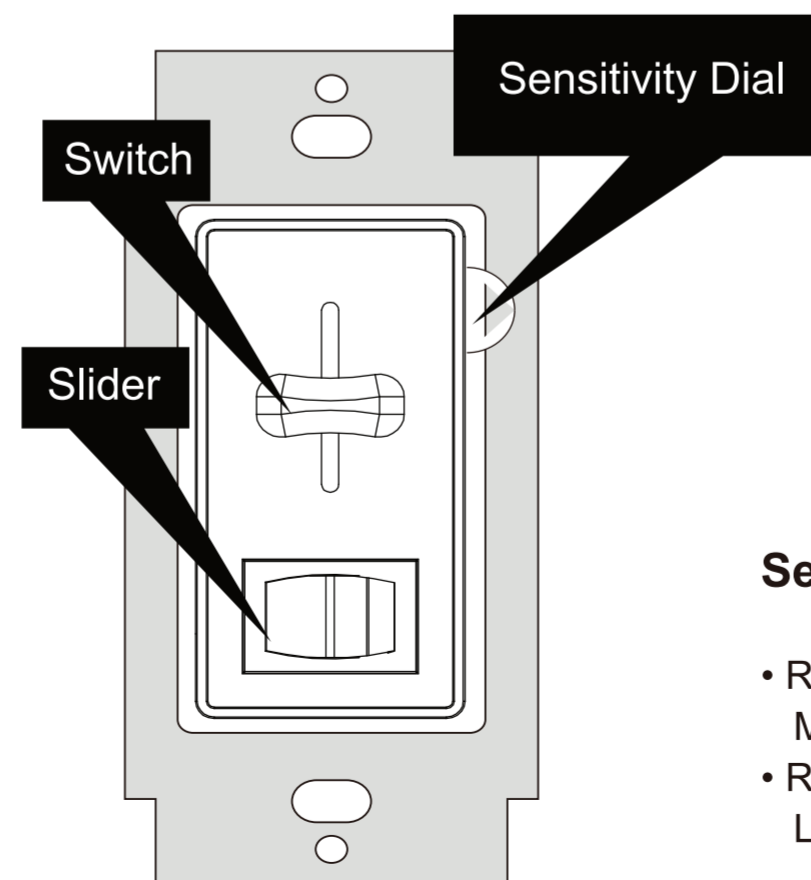

Sensitivity Dial

- Rotate Counter-Clockwise
More Bright
- Rotate Clockwise
Less Bright

TROUBLESHOOTING

Symptom:

- Bulbs turn off while being dimmed.
- Bulbs turn on at high light level but do not turn on at a low light level, or take too long to turn on at low end.
- Bulbs flicker or flash when dimmed do a low light level.
- Bulbs or dimmers are buzzing.

Solution:

1. Verify all bulbs are marked dimmable.
2. Remove wallplate and locate sensitivity dial.
3. Turn up (counter-clockwise) sensitivity dial slowly until symptom is no longer present.

WARRANTY

BESTTEN warrants to the original customer that this product is free of defects in materials and workmanship for one year from the purchase date. Within this period, simply contact BESTTEN CARE with proof of purchase and reason of claim. We will replace the product for free.

Any product which is subject to misuse or accidental damage is excluded from this warranty.

BESTTEN CARE
support@ibestten.com
1-800-358-6160 (Mon-Fri 9AM-5PM PST)

For more products from BESTTEN, please visit our website www.ibestten.com.

