



[www.isolarparts.com](http://www.isolarparts.com)

## PRODUCT MANUAL

Get more information

**Shenzhen Solarparts Inc.**  
Made in china

**2023**  
Dedicated to the  
Photovoltaic Industry



## Contact us

 Tel:+86-13923729619  
Fax:+86-75585233441

 401, Bldg B, 3th Road, Xinglian industrial Park,  
Hehua community, Pinghu Street, Longgang  
District, Shenzhen City 518111 China

 [isolarparts.com](http://isolarparts.com)

 [Philip@isolarparts.com](mailto:Philip@isolarparts.com)



Shenzhen Solarparts Inc.

# Content Guide



Founded in 2011, Shenzhen Solarparts Inc. is a professional manufacturer of solar panels and a national high-tech enterprise.

Solarparts has developed a wide range of adapted products for RVs, yachts, outdoor applications, balcony systems, and camping.



Global Off-Grid PV System Solution Leader & Innovator

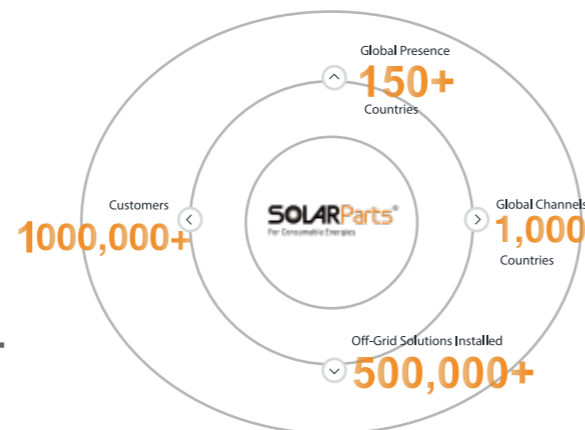
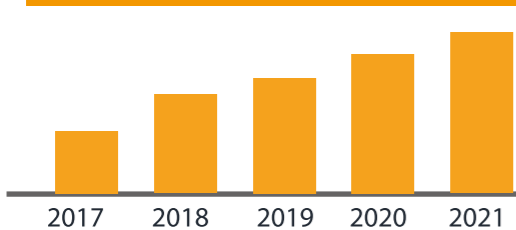

- 1.Content Guide \_\_\_\_\_ 01
- 2.Solarparts@\_Micro Balcony System \_\_\_\_\_ 03-04
- 3.Off-Grid Solar Panel System \_\_\_\_\_ 05-13
  - Off-grid Solar Panel Kits
    - Boguang@\_F Series
    - Boguang@\_R Series
    - Lixin@Off-Grid Home Solar Systems
  - Solar and Wind Hybrid Generation Systems
  - Photovoltaic solar heating system
  - Solar Roof Exhaust Fan
- 4.Solar Power Projects and Services--EPC \_\_\_\_\_ 14-17
- 5.Rigid Solar Panel \_\_\_\_\_ 18-19
- 6.Flexible Solar Panel \_\_\_\_\_ 20-22
  - Solarparts@\_Flexible Series
  - Xinpuguang@\_Flexible Series
  - Solarparts@\_Sandwich\_Flexible Series
- 7.Portable Solar Panels \_\_\_\_\_ 23-28
  - Roicht@\_IN Series
  - Roicht@\_BA Series
  - PCB Folding Box
  - Roicht@\_Glass Foldable Box
- 8.Small Solar Panel \_\_\_\_\_ 28-30
  - Keruft\_Mini P Series
  - Keruft\_Mini E Series
- 9.Solarparts@\_Battery & Accessories \_\_\_\_\_ 31-32





# Solarparts@\_Micro Balcony System

## Plug and Play On-Grid Micro Solar System



150-900W Designed for balcony energy

The system is very easy to install. No need to call a professional. Simply connect the solar panels in series and parallel to the micro-inverter. Then connect it to your home outlet and you're ready to go. Plug and Play!

When the sun shines, the solar panel set will produce DC voltage, and the micro grid tie inverter transforms the DC voltage to AC voltage, synchronizing with the utility grid power. It puts out power to the home grid, generating electricity and cutting your electric bill.



Tied balcony micro grid-connected system Configuration				
Module	Solar panel	Micro inverter	Cable	Black Nylon Bind
150W System	PG1-150W*1PC	180W/230V	1 set	1 set
300W System	PG1-150W*2PCS	300W/230V	1 set	1 set
600W System	PG1-150W*4PCS	600W/230V	1 set	1 set
900W System	PG1-150W*6PCS	1200W/230V	1 Set	1 set



Hanging Balcony Micro Grid-connected System Configuration				
Module	Solar panel	Micro inverter	Cable	Triangular Bracket
300W System 1	PG2-150W*2PCS	300W/230V	1 set	2 PCS
300W System 2	PG-300W*1PCS	300W/230V	1 set	4 PCS
600W System1	PG2-150W*4PCS	500W/230V	1 set	8 PCS
600W System2	PG-300W*2PCS	600W/230V	1 set	4 PCS
900W System	PG2-150W*6PCS	1200W/230V	1 set	12 PCS



Foldable Balcony Micro Grid-Connected System Configuration				
Module	Solar panel	Micro inverter	Cable	Foldable metal bracket
150W System	PG2-150W*1PC	180W/230V	1 set	1 set
300W System	PG2-150W*2PCS	300W/230V	1 set	2 sets
600W System	PG2-150W*4PCS	600W/230V	1 set	4 sets
900W System	PG2-150W*6PCS	1200W/230V	1 set	6 sets



Solar Panel Electrical Parameters at (STC) (optional)

Solar Panel	Pmax(W)	Vmp(V)	Imp(A)	Voc(V)	Isc(A)	Dimension(mm)	Weight	Module Efficiency	Performance Tolerance
PG1-150W	150W	19.8V	7.58A	23.76V	8.33A	1155*715*3	/	0.19	±5%
PG2-150W	150W	19.8V	7.58A	23.76V	8.33A	1140*700*25	7.5Kg	0.1867	±5%
PG-300W	300W	29.7V	10.1A	35.64V	11.1A	1555*1045*30	17Kg	0.1867	±5%
PG-450W	450W	34.67V	12.98A	41.25V	13.89A	1909*1134*35	23.9Kg	0.1867	±5%
PG-500W	500W	38.43V	13.01A	46.12V	14.3A	2094*1134*35	23.5Kg	0.1867	±5%



# Off-grid Solar Panel Kits

- Boguang@\_F Series
- Boguang@\_R Series
- Lixin@Off-Grid Home Solar Systems



150-900W Designed for home energy

The solar energy is converted into electric energy, and the load is powered by the solar charge and discharge controller, and the battery pack is charged at the same time; when there is no light, the battery pack supplies power to the DC load through the solar charge and discharge controller, and the battery also directly supplies the independent inverter.

Power supply, invert into AC power through an independent inverter, and supply power to the AC load.electric bill.



Boguang@_F Series Solar Kit Configuration						
Module	Solar Panel	Controller	Cable	Adapter	Aluminum Bracket	Inverter
100W/12V Solar Kit	100W*1PC	10A	2 sets	/	1 set	optional
200W/12V Solar Kit	100W*2PCS	20A	2 sets	1 set	1 set	optional
400W/12V Solar kit	100W*4PCS	40A	2 sets	1 set	1 set	optional
500W/12V Solar kit	100W*5PCS	50A	2 sets	1 set	1 set	optional
600W/24V Solar kit	100W*6PCS	50A	2 sets	1 set	1 set	optional
800W/24V Solar Kit	100W*8PCS	60A	4 sets	1 set	1 set	optional



Boguang@_R Series Solar Kit Configuration						
Module	Solar Panel	Controller	Cable	Adapter	Aluminum Bracket	Inverter
100W/12V Solar Kit	100W*1PC	10A	2 sets	/	1 set	optional
150W/12V Solar Kit	150W*1PC	20A	2 sets	/	1 set	optional
200W/12V Solar Kit	100W*2PCS	20A	2 sets	1 set	1 set	optional
300W/12V Solar Kit	150W*2PCS	30A	2 sets	1 set	1 set	optional
400W/12V Solar kit	100W*4PCS	40A	2 sets	1 set	1 set	optional
450W/12V Solar kit	150W*3PCS	50A	2 sets	1 set	1 set	optional
500W/12V Solar kit	100W*5PCS	50A	2 sets	1 set	1 set	optional
600W/12V Solar kit	150W*4PCS	60A	2 sets	1 set	1 set	optional
600W/24V Solar kit	100W*6PCS	50A	2 sets	1 set	1 set	optional
800W/24V Solar Kit	100W*8PCS	60A	4 sets	1 set	1 set	optional



Lixin@Off-Grid Home Solar Systems Configuration 1 (300W-1200W)							
Module	Solar Panel (Rigid)	battery	Hybrid Inverter	Aluminum Bracket	Cable	PV Connector	screw
300W/12V System	150W * 2PCS	200AH/12V	12V/1000W-230V	Z-type, 1 set	3 sets	1 set	1 set
400W/12V System	100W * 4PCS	200AH/12V	12V/1000W-230V	Z-type, 1 set	3 sets	1 set	1 set
450W/12V System	150W * 3PCS	200AH/12V	12V/1000W-230V	Z-type, 1 set	3 sets	1 set	1 set
500W/12V System	100W * 5PCS	200AH/12V	12V/1000W-230V	Z-type, 1 set	3 sets	1 set	1 set
400W/24V System	100W * 4PCS	200AH/12V*2PCS	24V/2400W-230V	Z-type, 1 set	5 sets	1 set	1 set
600W/24V System	100W * 6PCS	200AH/12V*2PCS	24V/2400W-230V	Z-type, 1 set	3 sets	1 set	1 set
600W/24V System	150W * 4PCS	200AH/12V*2PCS	24V/2400W-230V	Z-type, 1 set	4 sets	1 set	1 set
800W/24V System	100W * 8PCS	200AH/12V*2PCS	24V/2400W-230V	Z-type, 1 set	4 sets	1 set	1 set
900W/24V System	150W * 6PCS	200AH/12V*2PCS	24V/2400W-230V	Z-type, 1 set	4 sets	1 set	1 set
1000W/24V System	100W * 10PCS	200AH/12V*2PCS	24V/2400W-230V	Z-type, 1 set	4 sets	1 set	1 set
1200W/24V System	100W * 12PCS	200AH/12V*4PCS	24V/2400W-230V	Z-type, 1 set	4 sets	1 set	1 set
1200W/24V System	150W * 8PCS	200AH/12V*4PCS	24V/2400W-230V	Z-type, 1 set	4 sets	1 set	1 set





### Lixin@Off-Grid Home Solar Systems Configuration 2 (1KW-5KW)

Components	PG1KW-OFF	PG2KW-OFF	PG3KW-OFF	PG4KW-OFF	PG5KW-OFF
300W Mono Solar Panel	2 Pieces	4 Pieces	6 Pieces	9 Pieces	12 Pieces
Combiner Box	2 in 1 out	2 in 1 out	2 in 1 out	3 in 1 out	4 in 1 out
Off Grid Inverter	1KW	2KW	3KW	4KW	5KW
12V 200AH GEL Battery	1 Piece	2 Pieces	4 Pieces	4 Pieces	8 Pieces
DC Cable	100 Meters	100 Meters	200 Meters	200 Meters	200 Meters
MC4 Connector	4 Pairs	4 Pairs	6 Pairs	6 Pairs	8 Pairs
Mounting System	Ground or Roof ( Customized Optional )				

### Lixin@Off-Grid Home Solar Systems Configuration 3 (10KW-30KW)

Components	PG10KW-OFF	PG15KW-OFF	PG20KW-OFF	PG25KW-OFF	PG30KW-OFF
380W Mono Solar Panel	27 Pieces	36 Pieces	45 Pieces	60 Pieces	70 Pieces
Combiner Box	3 in 1 out	4 in 1 out	5 in 1 out	6 in 1 out	7 in 1 out
Off Grid Inverter	10kVA	15kVA	20kVA	25kVA	30kVA
12V 250AH GEL Battery	16 Pieces	16 Pieces	20 Pieces	40 Pieces	40 Pieces
DC Cable	4mm2/400 Meters	4mm2/400 Meters	4mm2/600 Meters	4mm2/800 Meters	4mm2/800 Meters
	25mm2/100 Meters	25mm2/100 Meters	25mm2/200 Meters	25mm2/200 Meters	25mm2/200 Meters
MC4 Connector	10 Pairs	12 Pairs	15 Pairs	20 Pairs	25 Pairs
Mounting System	Ground or Roof ( Customized Optional )				



### Lixin@Off-Grid Home Solar Systems Configuration 4 (1KW-10KW)

Components	SZ1KW-OFF	SZ3KW-OFF	SZ5KW-OFF	SZ8KW-OFF	SZ10KW-OFF
480W Solar Panel	2 Pieces	6 Pieces	10 Pieces	16 Pieces	21 Pieces
Combiner Box	1 Unit	1 Unit	1 Unit	1 Unit	1 Unit
Off Grid Inverter	1kw	3kw	5kw	8kw	10kw
12V 200AH/250 GEL Battery	1 Piece	2 Pieces	4 Pieces	4 Pieces	8 Pieces
DC Cable	100 Meters	100 Meters	200 Meters	200 Meters	200 Meters
MC4 Connector	4 Pairs	4 Pairs	6 Pairs	6 Pairs	8 Pairs
Mounting System	Ground or Roof ( Customized Optional )				

## Solar-Wind Hybrid System



Combined to produce green electricity

The two most abundant renewable energy sources are the sun and the wind. Combined and converted into a single energy source via artificial means, they are known as Solar-Wind Hybrid System.

In this system, solar and wind energies are combined to produce green electricity.



300W-500W



Solar-Wind Hybrid System Configuration				
Item	300W System	400W System	450W System	500W System
Solar Panel	PG-150W*2PCS	PG-100W*4PCS	PG-150W*3PCS	PG-100W*5PCS
Wind Turbine	1PC	1PC	1PC	1PC
Battery	200AH/12V*1PC	250AH/12V*1PC	200AH/12V*1PC	250AH/12V*1PC
Controller	1 unit	1 unit	1 unit	1 unit
Inverter	1 unit	1 unit	1 unit	1 unit
Bracket	1 set	1 set	1 set	1 set
Cable	5 sets	5 sets	5 sets	5 sets
Small Accessories	1 set	1 set	1 set	1 set

Accessories



Accessories of Solar-Wind Hybrid System	
Item	Specification
Solar Panel	PG-100W: 100W/19.8V 1050*530*25mm PG-150W: 150W/19.8V 1140*700*25mm
Wind Turbine	NE-500M2;500W/DC12V
Battery	200AH/12V or 250AH/12V
Controller	12/24-W500/S500 ; 500W
Inverter	2000W/230V
Bracket	Aluminum alloy Z bracket
Cable	4mm <sup>2</sup> /5mm <sup>2</sup> /16mm <sup>2</sup>
Small Accessories	Screw,Nut,(M6)
Terminal	OT-60A

# Photovoltaic Solar Water Heating System



Make your life easier.

By providing up to 70% of a household's hot water through free energy from the sun. A photoelectric solar water heating system can reduce your annual energy bills.

Using more renewable energy from the sun rather than buying fossil fuels like gas or oil from a supplier will reduce your carbon footprint.

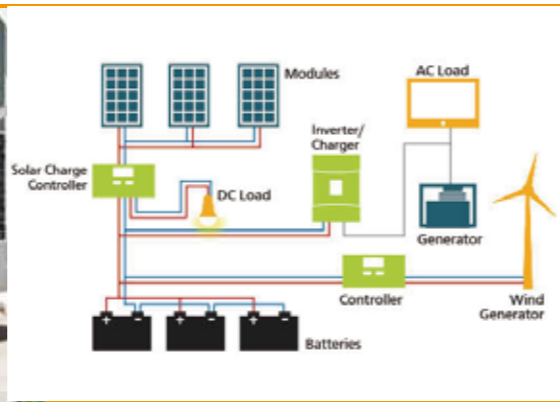



## Solar Roof Exhaust Fan



Combined to produce green electricity

A roof mounted axial type solar powered active ventilation fan, driven by brushless dc motor and run for air exchanging, to improve air circulation in roof cavity or attic space freely at no cost.

Ideal for residential house, garage, basement, industrial workshop, livestock feeding shed, poultry house, agricultural green house,

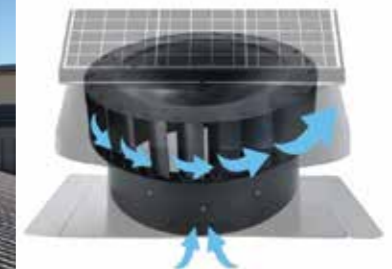

### 60L/80L Bill of materials

Type	Specification	Quantity	Remarks note
Solar panel	540W/41.62V 2279*1134*35m	2	
Water heater	60L; 2-230V/50Hz Weight: 21kg 80L; 2-230V/50Hz weight : 25kg	1	
Cable	Photovoltaic system; red and black lines 1x4mm <sup>2</sup> , 20M each	1	Photovoltaic connected solar water heater
	Brown/blue/yellow-green three-core cable, 3*2.5mm <sup>2</sup> , 1.5M, with ohmmeter plug	1	Power grids is connected to a solar water heater
Packing box	Double pit; outer dimension; ;490*520*940mm 6mm thick	1	
Middle box	Outer size; 2295*1150*80mm 6mm thick	1	



Round



Square

### Solar Roof Exhaust Fan Components List

Solar Panel	18~ 50W polycrystalline solar panel
Motor	18~ 22.5V brushless DC motor
Fan Blades	12" / 14" Nylon- fiberglass fan blades, 7 pcs
Air duct dia	315mm / 368mm
Shape	Round / Square fan cover, square fan base
Fan Case	Galvanized steel fan case with powder coating
Color	black/ white / orange / green
Fan host size	530x530x255mm
Work time	sunny day hours, when sunlight is available( battery / electricity backup is available for running nonstop in sunless time )
Optional accessory	adapter, remote controller, manual switch, thermostat, fan guard

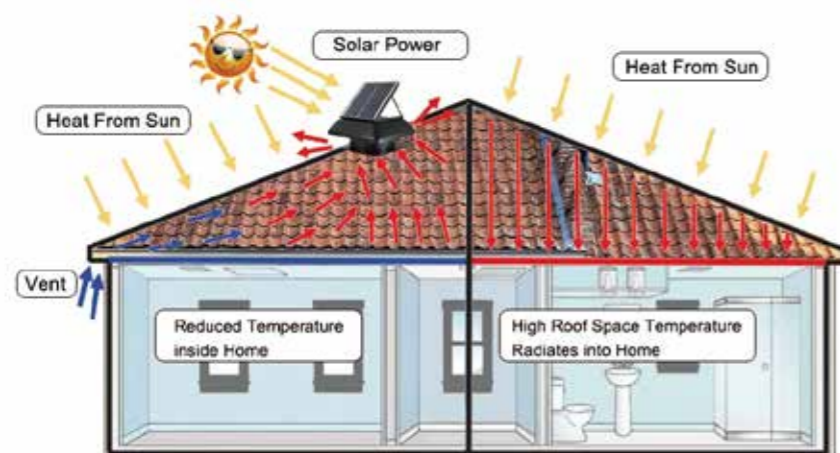

## Solar Power Projects And Services--EPC

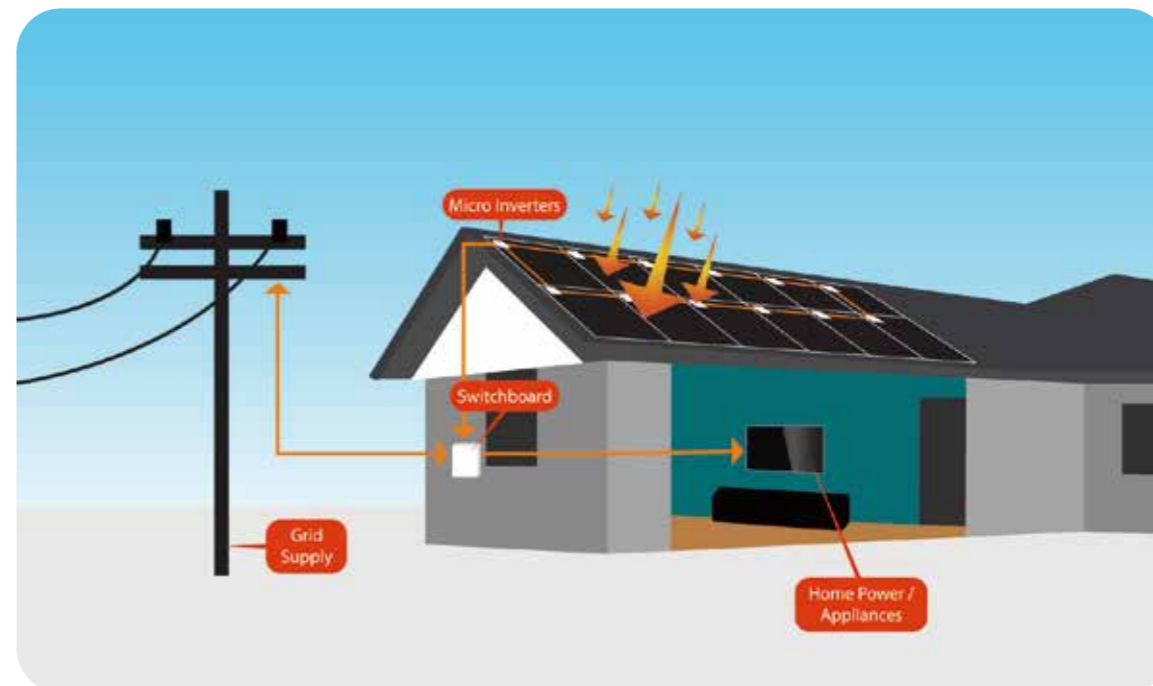

The grid-connected photovoltaic power generation system can convert the DC power output by the solar cell array into AC power with the same amplitude, frequency and phase as the grid voltage, and realizes the connection with the grid and transmits electricity to the grid.





# Grid-connected EPC System



1.35KW On-Grid Solar Power Kit Components List			
Item	Model	Description	Quantity
1	Solar panels	450W/34.67V 1909mm*1134m m*30mm	3 pcs
2	On-Grid Inverter	5KW/220VAC	1 pc
3	Connector	MC4	1 set
4	Bracket	Roof/Ground	1 set
5	Cable 1	4mm <sup>2</sup> PV cable	20m
6	Cable 2	16mm <sup>2</sup> PV cable	20m
7	Cable 3	4mm <sup>2</sup> Earth Wire	10m
8	AC combiner box	Protector	1 set



3.15KW On-Grid Solar Power Kit Components List			
Item	Model	Description	Quantity
1	Solar panels	450W/34.67V 1909mm*1134m m*30mm	7 pcs
2	On-Grid Inverter	5KW/220VAC	1 pc
3	Connector	MC4	1 set
4	Bracket	Roof/Ground	1 set
5	Cable 1	4mm <sup>2</sup> PV cable	20m
6	Cable 2	16mm <sup>2</sup> PV cable	20m
7	Cable 3	4mm <sup>2</sup> Earth Wire	10m
8	AC combiner box	Protector	1 set



**Effective and professional team**



Keeping track with the market development, we are engaged in providing our clients EPC For Grid Connected Rooftop Solar PV Systems, Hybrid Rooftop Solar PV System and Off Grid Rooftop Solar PV System .

This power is then sent to a Solar Inverter with converts the DC electricity to AC power which can be used by your appliances. Any surplus power is then exported to the grid and credited against your electricity bill.

Our company has created a niche in the field of providing Solar Power Projects And Services.

Keeping track with the market development, we are engaged in providing our clients EPC For Grid Connected Rooftop Solar PV Systems, Hybrid Rooftop Solar PV System and Off Grid Rooftop Solar PV System .

With the help of our team of adroit professionals, we render this service according to the exact needs of clients. Furthermore, we use advanced techniques with high precision in order to execute this service. It is highly demanded due to its swiftness, reliability and flexibility. like gas or oil from a supplier will reduce your carbon footprint.





### EPC For Grid Connected Rooftop Solar PV Systems

Kind of Application	Industrial
Installation Method	Roof Top
Preferred Wattage	20 kW to 1 MW
Size/Area	200 to 1000 Square Feet
Grid Type	Grid Tie

### EPC For Hybrid Rooftop Solar PV System

Kind of Application	Industrial
Installation Method	Roof Top
Preferred Wattage	20 kW to 1 MW
Size/Area	200 to 1000 Square Feet
Grid Type	Hybrid-On Grid/Off Grid

### EPC for Off Grid Rooftop Solar PV System

Kind of Application	Industrial
Installation Method	Roof Top
Preferred Wattage	20 kW to 1 MW
Grid Type	Off Grid

### Service Procedure

Site survey, investigation, Design, Engineering, Energy Supply, Installation, Testing, Commissioning, Synchronizing and Maintenance of Solar PV Systems on Net Metering Basis on the Roofs of Buildings.

## Xinpuguang@\_Rigid Series (5W-300W )



**Make your life easier.**

High in power and durable, Xinpuguang@ Rigid Series - Monocrystalline modules are the perfect addition to any off-grid application. Easy to install with pre-drilled holes on the back of panel for fast mounting and securing. Can be matched with various solar panel brackets.ss.







## Flexible Solar Panel

- Solarparts@\_Flexible Series    ■ Xinpuguang@\_Flexible Series
- Solarparts@\_Sandwich\_Flexible Series

High light transmittance, high charging efficiency, good weather resistance. It can be installed on the surface of the yacht arbitrarily, RVs and roofs.

Cell type	Pmax(W)	Vmp(V)	Imp(A)	Voc(V)	Isc(A)	Performance Tolerance	Size(mm)	Weight(kg)	Packing (mm)	Efficiency	40 'high cabinet (L:12MXW:2.34M+H:2.69)
156 Mono	10W	18	0.56	21.6	0.61	±5%	330*245*18	0.8	1170*350*270 50PC/CTN	18%	24300pcs/40HQ
	20W	18	1.11	21.6	1.22	±5%	505*295*18	1.53	610*540*330 25PC/CTN	20%	12600pcs/40HQ
	30W	18	1.67	21.6	1.83	±5%	630*345*18	2.23	660*500*380 20PC/CTN	18%	7680pcs/40HQ
	40W	17.4	2.3	20.88	2.53	±5%	665*520*25	3.8	700*330*550 10PC/CTN	16%	3840pcs/40HQ
125 Mono	50W	16	3.13	19.2	3.44	±5%	545*535*25	3.2	580*330*570 10PC/CTN	20%	2424pcs/40HQ
166Mono	60W	16.5	3.64	19.8	3.99	±5%	650*540*17	3.5	685*250*575 10PC/CTN	20%	5120pcs/40HQ
161 Mono	80W	16.5	4.85	19.8	5.33	±5%	950*530*25	5.5	990*180*560 5PC/CTN	20%	2160pcs/40HQ
125 Mono	100W	18	5.56	21.6	6.11	±5%	1160*530*25	6.7	1175*545*70 2PC/CTN	20%	2376pcs/40HQ
161 Mono	100W	18	5.56	21.6	6.11	±5%	1020*515*25	5.7	1135*530*70 2PC/CTN	22%	2376pcs/40HQ
166 Mono	100W	18	5.56	21.6	6.11	±5%	955*530*25	5.5	970*545*70 2PC/CTN	22%	2904pcs/40HQ
	150W	30	5	36	5.5	±5%	1040*795*30	8.8	1060*810*80 2PC/CTN	22%	1456pcs/40HQ
125 Mono	200W	36	5.56	43.2	6.11	±5%	1580*808*35	13.8	1600*825*90 2PC/CTN	20%	200W & 100W/40HQ 200W:676pcs 100W:726pcs
156 Mono	200W	18	11.11	21.6	12.22	±5%	1460*670*35	10.6	1480*695*90 2PC/CTN	22%	1092pcs/40HQ
166 Mono	200W	19.8	10.1	23.7	10.8	±5%	1545*700*35	11.8	1565*715*90 2PC/CTN	21%	1092pcs/40HQ
166 Mono	200W	19.8	10.1	23.7	11.1	±5%	1045*1030*25	11	1075*1060*702P C/CTN	21%	1200pcs/40HQ
182Mono	240W	35.2	6.8	42.24	7.48	±5%	1525*770*30	9.3	1555*800*80 2PC/CTN	22%	728pcs/40HQ
156 Mono	250W	30	8.34	36	9.18	±5%	1520*990*35	16.5	1540*1005*90 2PC/CTN	20%	728pcs/40HQ
166 Mono	300W	29.7	10	35.64	11	±5%	1550*1045*35	17.8	1570*1060*90 2PC/CTN	21%	728pcs/40HQ
182Mono	300W	34.2	6.77	41.04	9.65	±5%	1290*1135*30	14.15	1320*1165*802P C/CTN	22%	832pcs/40HQ
156 Mono	320W	38.1	8.4	45.72	8.82	±5%	1956*992*40	20.3	1980*1010*100 2PC/CTN	18.50%	528pcs/40HQ
156 Mono	350W	38.8	9.02	46.56	9.47	±5%	1956*992*40	20.3	1980*1010*100 2PC/CTN	20%	528pcs/40HQ
156 Mono	360W	39.1	9.21	46.92	9.67	±5%	1956*992*40	20.3	1980*1010*100 2PC/CTN	21%	528pcs/40HQ
182Mono	360W	34.2	10.5	41.04	11.55	±5%	1540*1135*30	16.9	1570*1165*802P C/CTN	22%	728pcs/40HQ
182 Mono	360W	34.2	10.53	41.04	11.16	±5%	1540*1134*35	18.8	1560*1150*90 2PC/CTN	22.60%	728pcs/40HQ
156 Mono	370W	39.3	9.41	47.16	9.89	±5%	1956*992*40	20.3	1975*1010*100 2PC/CTN	22%	528pcs/40HQ
166 Mono	400W	39.6	10	47.52	11	±5%	2055*1045*35	23	2075*1060*90 2PC/CTN	21%	572pcs/40HQ
182Mono	400W	30	13.3	36	14.63	±5%	1695*1135*30	18.6	1725*1165*802P C/CTN	22%	624pcs/40HQ
156 Mono	450W	41.52	10.84	49.7	11.36	±5%	2120*1052*40	23.5	2140*1070*100 2PC/CTN	22%	480pcs/40HQ
166 Mono	450W	41.4	10.87	49.6	11.58	±5%	2094*1038*40	21	2124*1068*95 2PC/CTN	22%	440pcs/40HQ
166 Mono	500W	42.8	11.69	51.7	12.28	±5%	2185*1098*40	25.3	2210*1115*100 2PC/CTN	22%	480pcs/40HQ
182 Mono	540W	41.62	12.98	49.55	13.89	±5%	2279*1134*35	28.5	2300*1150*90 2PC/CTN	22.80%	540W&250W/40HQ 540W:280pcs 250W:364pcs

## Solarparts@\_Flexible Series



Cell type	Pmax(W)	Vmp(V)	Imp(A)	Voc(V)	Isc(A)	Performance Tolerance	Size(mm)	Weight (kg/pcs)	Packing (mm)	Efficiency	40 'high cabinet (L:12MXW:2.34M+H:2.69)
Sunpower	50W	17.6	2.84	21.12	3.124	±5%	555*535*3	1.153	575*545*30 Single and double pieces/box	20%	Single piece/box: 5544pcs/cabinet Double pieces/box: 11088pcs/cabinet
Sunpower	100W	17.6	5.68	21.12	6.248	±5%	1050*540*3	2.306	1070*550*30 Single and double pieces/box	20%	Single piece/box: 2772pcs/cabinet Double pieces/box: 5544pcs/cabinet
Sunpower	150W	29.7	5.05	35.64	5.555	±5%	555*535*3	3.459	1205*805*30 Single and double pieces/box	20%	150W Single piece/box: 1386pcs/cabinet 100W Single piece/box: 770pcs/cabinet 150W and 100W combined cabinet 150W Double pieces/box: 2772pcs/cabinet 100W Double pieces/box: 1540pcs/cabinet
Sunpower	180W	33	5.45	39.6	5.99	±5%	1315*795*3	4.1508	1335*805*30 Single and double pieces/box	20%	180W and 100W combined cabinet 180W Single piece/box: 1232pcs/cabinet 100W Single piece/box: 770pcs/cabinet 180W and 100W combined cabinet 180W Double pieces/box: 2464pcs/cabinet 100W Double pieces/box: 1540pcs/cabinet

# Xinpuguang@\_Flexible Series



# Solarparts@\_Sandwich\_Flexible Series

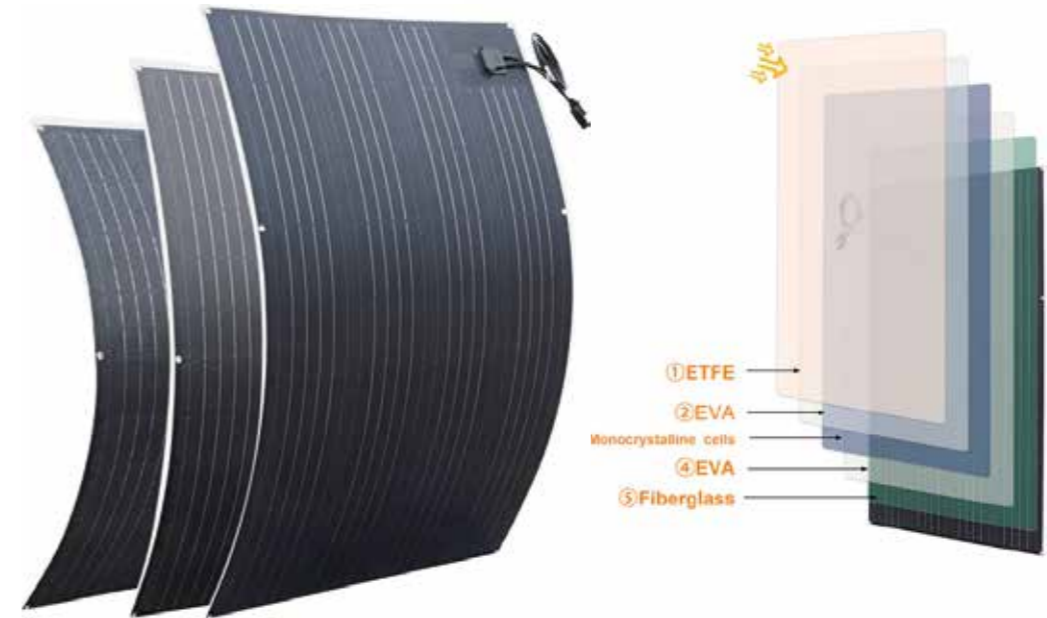

Cell type	Pmax(W)	Vmp(V)	Imp(A)	Voc(V)	Isc(A)	Performance Tolerance	Size(mm)	Weight (kg/pcs)	Packing (mm)	Efficiency	40 'high cabinet (L:12MXW:2.34M+H:2.69)
156 Mono	10W	18	0.56	21.6	0.61	± 5%	440*190*2.5	0.32	450*200*23 1piece/box	20%	Single piece/box: 1900pcs/cabinet
125 Mono	20W	16	1.25	19.2	1.38	± 5%	540*280*2.5	0.64	560*290*23 1piece/box	18%	Single piece/box: 1140pcs/cabinet
125 Mono	30W	5	6	6	5.5	± 5%	675*280*3	0.96	695*290*23 1piece/box	20%	Single piece/box: 9120pcs/cabinet
156 Mono	40W	18	2.2	21.6	2.44	± 5%	575*500*3	1.28	595*510*23 1piece/box	20%	Single piece/box: 6840pcs/cabinet
125 Mono	50W	16	3.12	19.2	3.43	± 5%	545*535*3	1.6	565*545*23 1piece/box	20%	Single piece/box: 6840pcs/cabinet
166 Mono	100w	19.8	5.05	23.76	5.55	± 5%	810*700*3	2.42	825*710*50 6piece/box	20%	Single piece/box: 1120pcs/cabinet

Cell type	Pmax(W)	Vmp(V)	Imp(A)	Voc(V)	Isc(A)	Performance Tolerance	Size(mm)	Weight (kg/pcs)	Packing (mm)	Efficiency	40 'high cabinet (L:12MXW:2.34M+H:2.69)
166 Mono	50W	18,7	2,67	22,44	2,91	± 5%	830*370*4	1,585	845*380*22 1 piece/box	20%	Single piece/box: 6700pcs/cabinet
166 Mono	100W	19,25	5,19	23,1	5,709	± 5%	1065*545*4	2,995	1080*555*22 1piece/box	20%	Single piece/box: 3600pcs/cabinet
166 Mono	150W	19,25	7,79	23,1	8,569	± 5%	1175*710*4	2,995	1080*555*22 1piece/box	20%	Single piece/box: 3600pcs/cabinet



# Portable Solar Panel

## ■ Roicht@\_IN Series

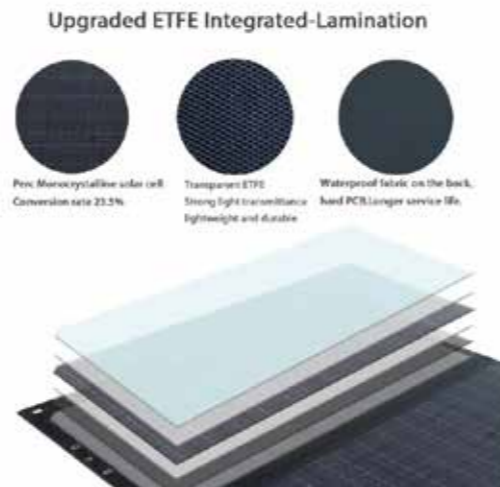

**Broad compatibility & higher efficiency**

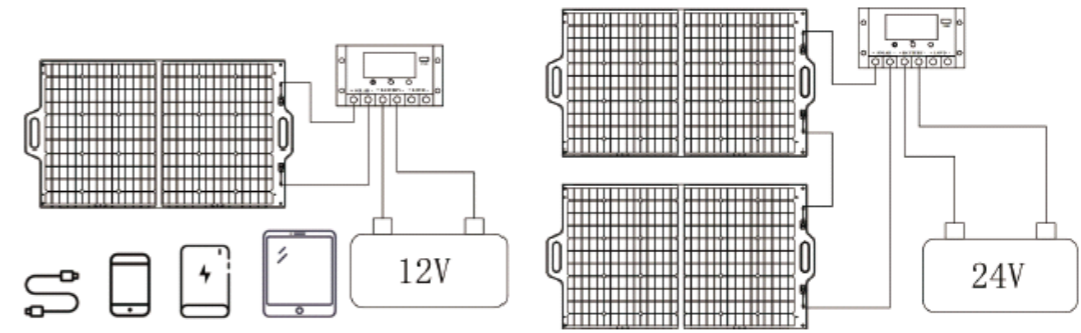

Portable solar panels-Roicht@\_IN Series

\*Standard test conditions: irradiance 1000W/m<sup>2</sup>, component temperature 25°C, wind speed 0m/s, AM=1.5

Cell type	Pmax(W)	SKU	Vmp(V)	Imp(A)	Voc(V)	Isc(A)	Unfolded Size(mm)	Folded Size(mm)	Weight(kg)	Packing(mm)	40 'high cabinet (L:12MxW:2.34M+H:2.69)
Mono cell	7W	205030051	7	1	8.4	1.1	295*190*4	295*190*4	0.3	320*220*40	12000 pcs/cabinet
Mono cell	14W	205030032	7	2	8.4	2.2	395*300*4	300*205*17	0.5	320*220*40	12000 pcs/cabinet
Mono cell	21W	205030052	7	3	8.4	3.3	590*300*4	300*205*25	0.7	320*220*40	12000 pcs/cabinet
Mono cell	28W	205030030	7	4	8.4	4.4	790*300*4	300*205*30	0.9	320*220*40	12000 pcs/cabinet
Mono cell	50W	205030053	19.8	2.52	23.76	2.77	830*370*4	430*540*33	2.05	565x450x55	4500 pcs/cabinet
Mono cell	100W	205030049	19.8	5.05	23.76	5.55	1065*545*4	430*540*40	3.6	565x450x55	4500 pcs/cabinet
Mono cell	100W	203010141	18	5.55	21.6	6.11	1228*665*20	665*620*20	4.1	685x640x60	2310 pcs/cabinet
Mono cell	150W	205010146	18	8.33	21.6	9.16	1626*730*20	730*545*40	6.25	755*554*50	2680 pcs/cabinet
Mono cell	200W	205010147	18	11.11	21.6	12.22	2330*665*20	665*620*45	8	685*640*60	2310 pcs/cabinet
Mono cell	260W	205030056	19.8	13.1	23.7	14.4	2396*705*20	665*614*20	11.7	800*750*140	750 pcs/cabinet
Mono cell	400W	205030058	39.6	10.1	47.5	11.1	2396*1050*4	638*1050*45	18	1170*750*140	280 pcs/cabinet

Roicht@\_IN Series products are popular solar folding bag style in the market. They are made of the industry's latest upgraded high-density monocrystalline silicon, which is smaller in size and has a higher conversion rate. OEM according to your requirements.



## ■ Roicht@\_BA Series



**Lightweight, easy to carry**



## ■ Foldable Solar Charger-PCB Folding Box

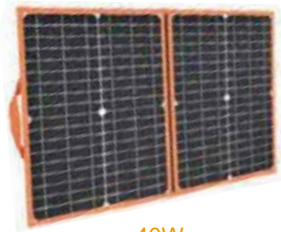

40W

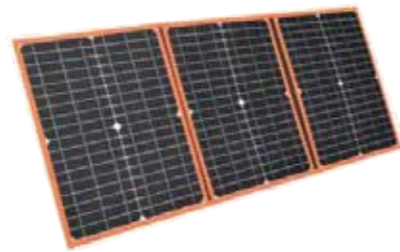

60W

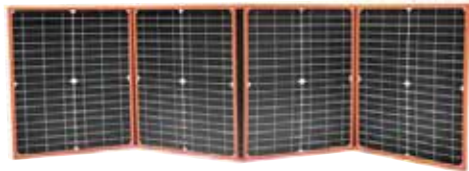

80W

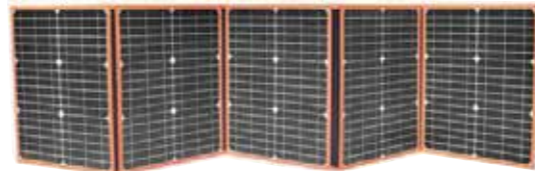

100W

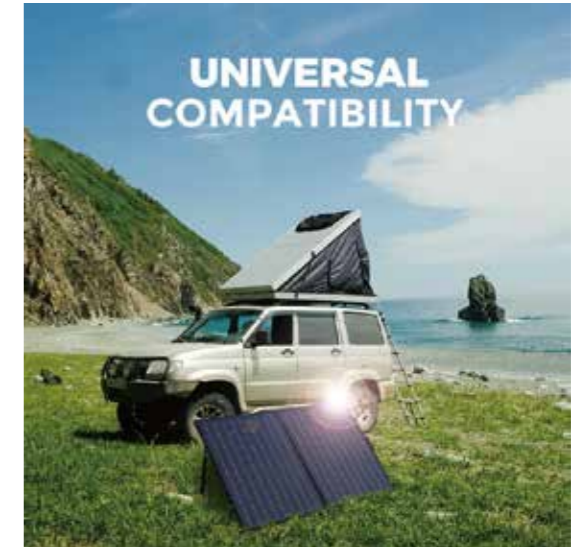

Convenient handle and the table's compact fold size

This folding camp table can be used as picnic table for outdoor, RV outside, BBQ, serving table for dining, small patio table for adult and kids, camping table for beach, fishing. It can also be regarded as a gift to your family and friends.

Through the folding design, the portable solar panel has a smaller area, is more convenient to carry, and needs to accommodate less space. It can be directly charged by electronic devices such as mobile phones, tablets, camera computers, and portable power supplies.

Adding a controller can directly use lead-acid batteries, lithium batteries and other vehicle-mounted batteries.





## Foldable solar charger-PCB Folding Box

\*Standard test conditions: irradiance 1000W/m<sup>2</sup>, component temperature 25°C, wind speed 0m/s, AM=1.5

Cell type	Pmax(W)	SKU	Vmp(V)	Imp(A)	Voc(V)	Isc(A)	Performance Tolerance	Size(mm)	Weight(kg)
156 Mono	2x50W	205040009	18	5.55	21.6	6.1	±5%	1025*680*25 680*510*53	5
156 Mono	2x100W	205040006	19.8	10.1	23.76	11.11	±5%	1065*1050*25 1050*530*53	6
156 Mono	2x150W	205040008	19.8	15.15	23.76	16.67	±5%	1405*1400*25 1400*700*53	9.5

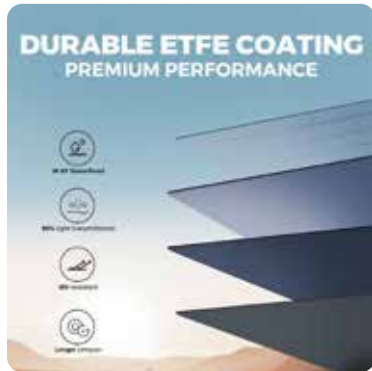

## Rigid Folding Solar Panel-Roicht@\_GL Series

\*Standard test conditions: irradiance 1000W/m<sup>2</sup>, component temperature 25°C, wind speed 0m/s, AM=1.5

Cell type	Pmax(W)	SKU	Vmp(V)	Imp(A)	Voc(V)	Isc(A)	Performance Tolerance	Size(mm)	Weight(kg)	Packing(mm)
156 Mono	2x50W	/	18	5.55	21.6	6.1	±5%	1025*680*25 680*510*53	7	700*530*70
125 Mono	2x100W	205010010	18	11.1	21.6	12.2	±5%	1325*915*25 915*660*53	10	935*680*70



## Rigid Folding Solar Panel-Roicht@\_GL Series



Easy transport and store.

## Small Solar Panel

### Keruft\_Mini E Series--Epoxy Resin Solar Modules





## ■ Keruft\_Mini P Series--PET Laminated Solar Modules



Pmax(W)	Model No.	Cell type	Vmp(V)	Imp(A)	Voc(V)	Isc(A)	Performance Tolerance	Size(mm)
0.125	PG-E-M0.125	Mono	0.5	0.250	0.6	0.275	±5%	48*21*2.8
0.125	PG-E-P0.125	Poly	0.5	0.250	0.6	0.275	±5%	70*25*3
0.2	PG-E-P0.21	Poly	0.5	0.4	0.6	0.44	±5%	60*60*2.8
0.21	PG-E-P0.21	Poly	0.5	0.42	0.6	0.46	±5%	85*85*2.5
0.245	PG-E-M0.245	Mono	3.5	0.07	4.2	0.077	±5%	56*42*3
0.275	PG-E-P0.275	Poly	5.5	0.05	6.6	0.055	±5%	85*45*2.8
0.3	PG-E-M0.3	Mono	6	0.058	7.2	0.064	±5%	85*45*2.8
0.45	PG-E-P0.45	Poly	4.5	0.1	23.76	0.11	±5%	85*45*2.8
0.5	PG-E-M0.5	Mono	5.5	0.09	6.6	0.099	±5%	65*65*2.8
0.65	PG-E-P0.65	Poly	5	0.13	6	0.143	±5%	120*62*2.8
1.26	PG-E-M1.26-1	Mono	18	0.07	21.6	0.077	±5%	111*111*3
1.26	PG-E-M1.26-2	Mono	6	0.21	7.2	0.231	±5%	110*80*2.8
1.5	PG-E-M1.5-1	Mono	6	0.25	7.2	0.275	±5%	136*112*5
1.5	PG-E-M1.5-2	Mono	5	0.3	6	0.33	±5%	Φ190*2.5
1.8	PG-E-M18	Mono	5	0.36	6	0.396	±5%	Φ145*3
2	PG-E-M2	Mono	18	0.21	21.6	0.13	±5%	136*110*3

Pmax(W)	Model No.	Cell type	Vmp(V)	Imp(A)	Voc(V)	Isc(A)	Performance Tolerance	Size(mm)
0.09	PG-PCB-M0.09	Mono	0.5	4.5	5.4	0.022	±5%	50*30*2.8
0.2	PG-PCB-M0.2	Mono	2	0.1	2.4	0.11	±5%	50*50*2.8
0.42	PG-PCB-M0.42	Mono	7	0.06	8.4	0.066	±5%	80*50*1.6
0.8	PG-PCB-M0.8	Mono	2	0.4	2.4	0.44	±5%	120*62*3
1.5	PG-PCB-M1.5	Mono	9	0.166	10.8	0.183	±5%	133.2*75.2*2.8
2	PG-PCB-M2	Mono	16	0.125	19.2	0.1375	±5%	165*96*2.5
2.8	PG-PCB-M2.8	Mono	18	0.155	21.6	0.17	±5%	350*60*2.8
3	PG-PCB-P3	Poly	7	0.25	8.4	0.275	±5%	110*110*3
4	PG-PCB-M4	Mono	6	0.666	7.2	0.733	±5%	210*135*2.8
5	PG-PCB-M5	Mono	6	0.833	7.2	0.916	±5%	270*175*3
5.5	PG-PCB-M5.5	Mono	15	0.366	18	0.403	±5%	317.7*127*2.8
6	PG-PCB-M6	Mono	13	0.461	15.6	0.507	±5%	500*86*3
6.5	PG-PCB-M6.5	Mono	18	0.361	21.6	0.397	±5%	280*180*3
6.5	PG-PCB-P6.5	Poly	18	0.361	21.6	0.397	±5%	305*152*3
10	PG-PCB-M10	Mono	18	0.555	21.6	0.61	±5%	260*230*2.5
10	PG-PCB-P10	Poly	18	0.555	21.6	0.61	±5%	136*110*3





# Solarparts@\_Battery & Accessories

## ■ Battery



## ■ Solar Charge Controller



## ■ Jixiao\_Off\_Grid Inverter



## ■ Chaodun@Hybrid Inverter



## ■ Chaodun@Micro Inverter



## ■ Solar Cables and Connector



## ■ Adapter

