

ZEROXCLUB Instructions Manual

ZEROXCLUB

Installations manual & Owner's Guide



ZEROXCLUB Wired Camera System Model # BY701A

Any questions or suggestions please send an email to customer service via
sales@uszeroxclub.com

ZEROXCLUB Instructions Manual

Before Using

Make sure you have the following listed items included in the packaging. If any item is damaged or missing, contact us at sales@uszeroxclub.com. It would be better if you wrote the order number from Amazon include photos of the damaged or missing part in your email, so that we can handle the problem much more quickly.

What's in the box

 <p>7-inch Monitor</p>	 <p>Rear View Camera</p>	 <p>Suction Cup Mount</p>	
 <p>U-Shaped Bracket</p>	 <p>Installation Tools</p>	 <p>Sunshade</p>	
 <p>Remote</p>	 <p>Card Slot Cover</p>	 <p>Extended 4pin cable</p>	 <p>User Manual</p>

ZEROXCLUB Instructions Manual

Test the System







To ensure that all components are working properly, please test the system before installation.

1. When the monitor is powered, the indicator light and buttons will light to indicate that the monitor is on and ready to work.

2. Perform a system function test by temporarily connecting the system. Test camera, monitor, and all functions of the monitor system. If the system seems to not be operating properly see troubleshooting or contact our customer service at sales@uszeroxclub.com.

ZEROXCLUB Instructions Manual

Table of contents

Before Using	II
Test the System	III
1. Safety Information	1
2. Installation	2
2.1 Installation Safety Precautions	2
2.2 Wiring	2
2.3 Monitor Installation	4
2.4 Camera Installation	5
2.5 Camera-Cables Installation	6
2.6 Testing the System	7
3.Operation	8
3.1 Operate the Monitor	8
3.2 Operate the Mini Remote Control	9
4.1  Move Mode	10
4.2  Still Quality	12
4.3  Clock Settings	13
4.4  Media Tool	14
4.5  General Settings	14
4.6  Language	16
5.FAQ	17
6.Troubleshooting	18
7.Warranty	22

ZEROXCLUB Instructions Manual

1. Safety Information

Incorrect installation can cause personal injury or property damage. For assistance contact **ZEROXCLUB** customer service.

NOTE: Handle all components with care. Inspect regularly for damage to components and cabling.

NOTE: Do not apply excessive force to any of the components contained within this kit. Excessive force used before, during or after installation that will result in damaged or non-functional parts.

- Do not disassemble or attempt to repair any part of the camera system.

- There are no user-serviceable parts inside the **ZEROXCLUB** camera system. Contact **ZEROXCLUB** customer service at sales@uszeroxclub.com if the part is ever compromised

- Children should be supervised to ensure that they do not play with the appliance.

- To avoid an electrical shock hazard, relevant actions should be performed by qualified and certified professionals. Disconnect all sources of power to the camera before installing.

- To reduce the risk of fire, NEVER test when smoking. Never use a flame.

- Use this product within the voltage range specified. Failure to do so can cause electronic shock or product malfunction.

- Where the power cable may touch a metal case, cover the cable with a friction tape. A short circuit or disconnected wire may cause a fire.

- Do not install the monitor where it may obstruct drivers view or obstruct an air bag device.

- Do not operate the monitor while driving, as it may cause an accident.

- Dropping the unit may cause possible mechanical failure.

ZEROXCLUB Instructions Manual

2. Installation

2.1 Installation Safety Precautions

- Ensure the power supply circuit has circuit protection
- Connect the rear camera to a 12-14V DC circuit only
- Use insulated tools when working with power supply
- Use correct safety equipment when working at elevated levels
- Ensure correct polarity of 12V DC power supply to the camera.

Red = Positive.Black=Negative.

- Do not allow water to enter the LCD Display.
- Excessive heat can be caused by a loose connection.

2.2 Wiring

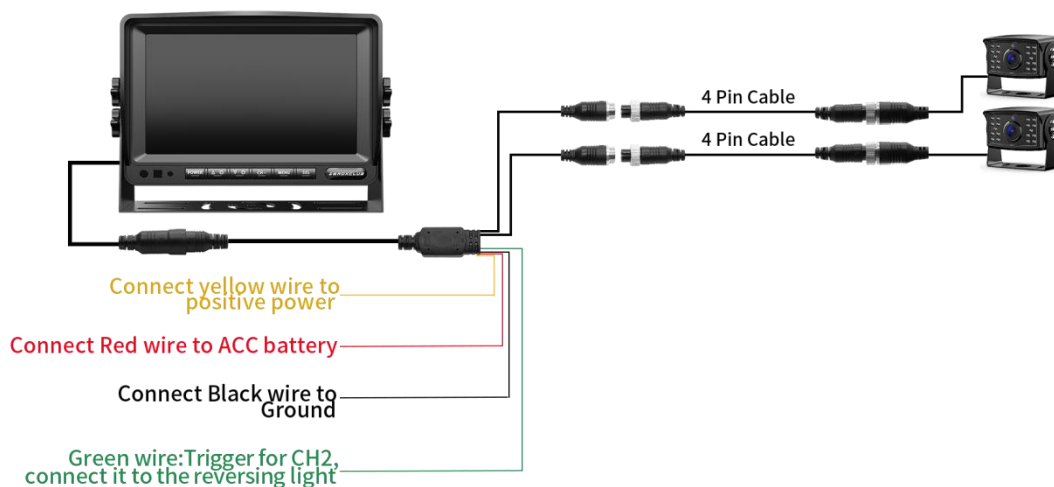

The wiring method when product use, as follows:

(1) Connect the **Yellow** wire to positive power(12-24V)

NOTE: The **Yellow** wire needs to be powered for a long time. If the **Yellow** wire has no power, the system will lose all the settings you made on the screen. We recommend that you connect the **Yellow** wire to the (+) positive terminal of the car's battery so that the system can save the settings and you will not have to reset them

ZEROXCLUB Instructions Manual

the next time the system is enabled.

(2) Connect the **Red** wire to ACC

The **Red** wire is connected to the car ignition wire ACC switch (which is the gear switch before starting up the car's motor), when the car key is turned on, the device will start automatically, and if the vehicle key is turned off, it will automatically turn off.

(3) Connect **Black** wire to negative power/ Ground / Sheet Metal

(4) Connect **Green** wire(CH2 trigger) to reversing light.

NOTE: This **Green** wire is used to trigger CH2 to display the reverse guideline. If the system as a continuous observation use, please ignore this wire and connect the camera to CH1. If as a reverse viewing with parking guideline only, please connect this wire to the reverse trigger ACC circuit and connect the camera to CH2.

NOTE: Connect the **Green** wire, the buttons on the display will be locked and cannot be operated, so please complete the screen operation before connecting the **Green** wire.

The wiring method when product test, as follows:

(1) Connect **Yellow** wire and **Red** wire together to the positive power (12-24V)

(2) Connect **Black** wire to Ground

(3) Ignore the **Green** trigger wire







NOTE: Connect the **Green** wire, the parking guide lines will appear. If you don't need it, ignore this the **Green** wire.

* Before installing it by professional person, please test it if works well, like image display, just in case and save your precious time. Please contact **ZEROXCLUB** Customer Service at sales@uszeroxclub.com if you have any questions.

ZEROXCLUB Instructions Manual

2.3 Monitor Installation

U Bracket Installation

<p>① Put on the sunshade as the blue dotted line</p>	<p>② Adjust the sunshade</p>	<p>③ Take out all the tools</p>
		
<p>④ Put the bracket on the fixed directions as the blue dotted lines shows</p>	<p>⑤ Align the screw holes</p>	<p>⑥ Fix or adjust the screen angle and screw on the knob bolts</p>
		

Suction Cup Mount Installation:





ZEROXCLUB Instructions Manual

2.4 Camera Installation

2.4.1 Rear Camera

The camera comes equipped with an adjustable flat mount base. You can adjust the lock-screws on the sides of the camera to adjust the lens of camera with a small Phillips screwdriver. A short 4 -pin aviation video cable is attached to the body of the camera.

Mark camera mounting position. Screw on according to the mark.	Tighten the screws on both sides of the camera. Adjust the camera angle as needed.
	

2.4.2 Adjust the Camera View

- You can use the camera mount to mark where to drill holes which is wide enough for the 4 pin connector.
- Adjust the camera to the correct angle as needed. The camera should be adjusted to a horizontal position relative to the ground in order to provide the best view of the objects behind the vehicle.
- When the preferred view for each camera is obtained, tighten the screws to prevent the camera angle from deviating due to vibration during driving.

NOTE: One important thing to note here is that the camera should face backward and that its view is not obstructed in any

ZEROXCLUB Instructions Manual

way. You should also make sure that the camera sits properly, and that a simple car bump or jerk, will not loosen it in any way. The third caution is making sure that the installation spot is not too far away and that it fits the cable length.

2.5 Camera-Cables Installation

- Define the routing of each of the camera cables. Connect the camera cable to the extension cable provided in the system (you can coil up the unused part if you need shorter feet), and run the extension through the car to the dash area.

- Connect the extension wire to 4pin plug from the monitor. All the cables you will need will come provided in the backup camera kit.

- Do not pull aggressively on the connector head of the cable when you are routing the cables through channels or tight spaces as this may damage the fine wires in the cable. Use a fish tape to thread the cables through these areas. Tape the cable securely to the fish tape to distribute the load when the tape is pulling the cable through the tight spots.

- When you install the 4pin cable, please target every pin to the hole, avoid breaking the pin. When the system is set-up the cables may now be properly secured and stowed.

- After connecting the wires, pay attention to the insulation between the power cables to prevent the power cables from short-circuiting the battery.

- Use plastic split-shield cable covers where appropriate to protect the cables in open areas.

- Secure the cables using adhesive 3M type $\frac{1}{4}$ " cable clips and/or

Align the detent channel and the 4 pins to the 4 holes, then push the connectors together. Screw the collar into position.



4-Pin Aviation Video Cable

ZEROXCLUB Instructions Manual

zip ties.

● You may have surplus cable length remaining in your installation. If this is the case, find a convenient place to bundle the cable with zip ties and securely hide it out of site. We do not recommend shortening the cable by cutting and rejoining it.

● You should also make sure the monitor only starts after ignition, so that you can preserve your battery. You can find the corresponding connection for the fuse box according to the manual for your car and model.

NOTE:

1) Before connecting, you need to confirm that the voltage of the battery is between 12-24V.

2) Rear cameras are usually powered by the reverse lights.

This makes them more convenient to use as the monitor and the camera will automatically turn on when you shift the gear into reverse.

2.6 Testing the System

If you are using a car charger, simply start the ignition and the camera will be activated. If you are using a DC Power Pigtailed Cable, you will also need to change to reverse gear and your backup camera image should come on.

NOTE: If there are any issues, then do not panic. Slowly check every single connection, and make sure that everything is correct. Make sure that the red/positive ends of a cable connect to red/positive on other cables, and that black/negative connects to

ZEROXCLUB Instructions Manual

black/negative as well. Also, check the power sources to make sure that they are correctly connected, and that no fuse has blown.

Conclusion

If you strictly follow this backup camera installation guide and all goes well, then your backup camera system should be correctly installed and fully functional.

3. Operation

3.1 Operate the Monitor

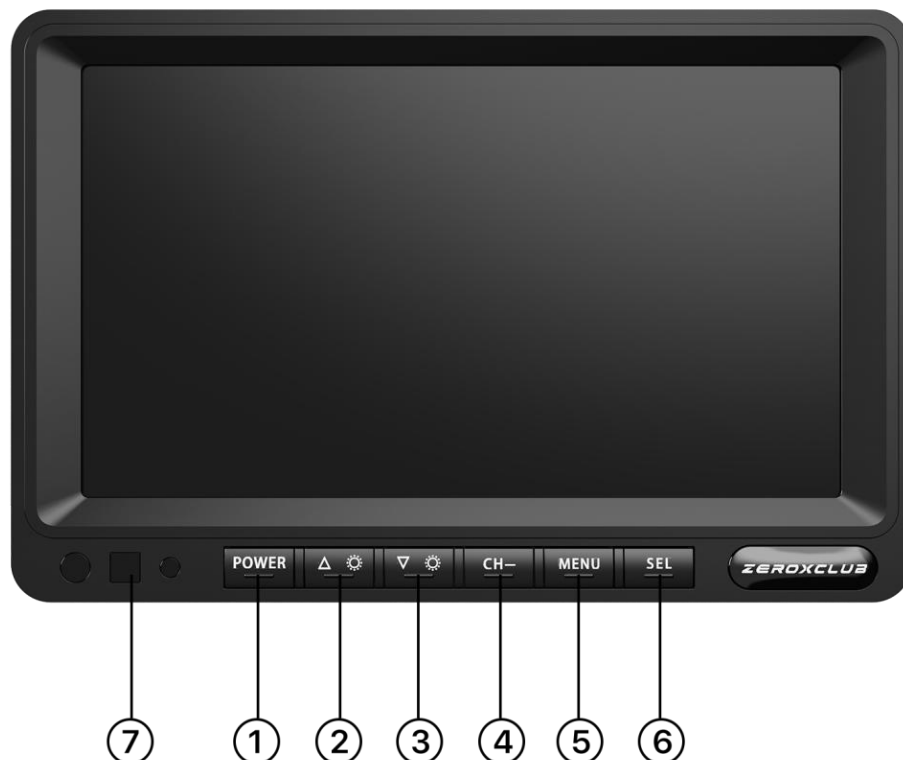

ZEROXCLUB Instructions Manual

①POWER	A power button turns the display device on or off.
②△☀	A Up/Increase button. Select forward in display operation
③▽☀	A Down/Decrease button. Select backward in display operation.
④CH	A Channel Switch button.
⑤MENU	A Menu/Return button. Press to access menu or return to the previous panel.
⑥SEL	A Confirm/Recording button. Press to confirm the option or to star/stop recording or to start/pause playback file.
⑦IR	IR Connector

3.2 Operate the Mini Remote Control

The system comes with a mini remote control, only need to unplug the transparent plastic sheet at the bottom, you can use it.

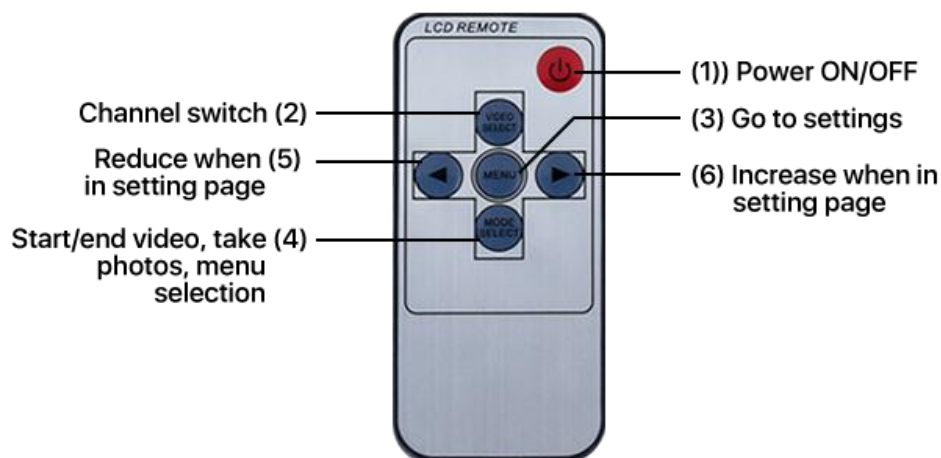

ZEROXCLUB Instructions Manual

4.Display Settings

Display settings allow you to adjust various aspects of your display to ensure that the display works well with your camera.

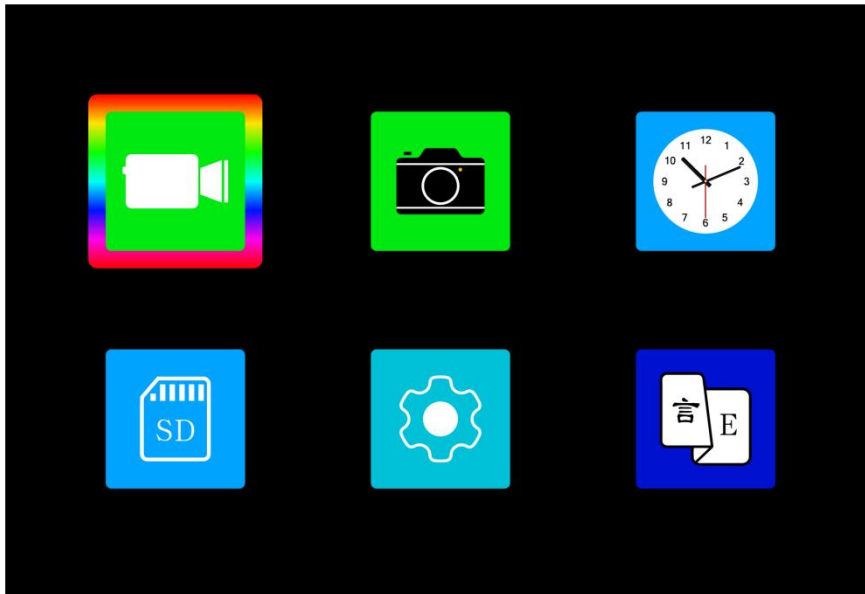

NOTE: If the screen is recording, please stop recording firstly, otherwise it can't enter the menu panel. (Press **SEL**, then the red dot on the display disappears, which means recording has stopped.)

4.1 Move Mode

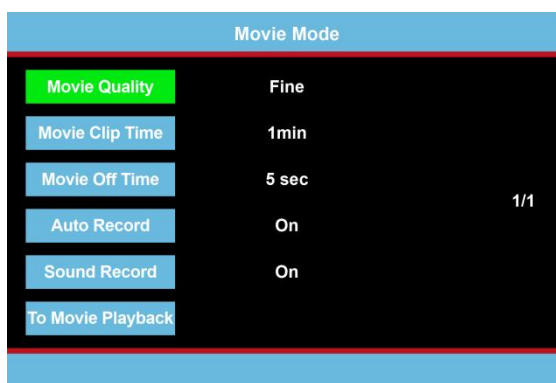

Press **MENU** → Go into the **Move Mode** → **SEL** → **+☀** (Skip to next option) // **-☀** (Back to the previous option) → **SEL** (confirm) → **+☀/-☀**

ZEROXCLUB Instructions Manual

(Increase/ decrease)→**MENU** (Back to the previous panel)

(1) **Movie Quality:** Super Fine/Fine

(2) **Movie Clip Time:** Off/ 1min/ 2min/ 3min/ 5min/ 10min

Time per recorded video file. If you choose “Off”, then the system will keep recording a long video until you stop or power off it.

(3) **Movie Off Time:** 0min/ 5sec/ 30sec/ 1min/ 3min

Recordable time for the screen when the engine is off.

(4) **Auto Record:** On/Off

If turn it on, the screen will automatically record when it is turned on.

(5) **Sound Record:** (Please ignore this function. In order to make our camera more robust and waterproof, the camera doesn't have a built-in microphone, so our system cannot record sound. Thanks for your understanding.)

(6) **To Movie Playback:** You can go to the playback panel and see the recorded video files.



You can switch to the AHD1 or AHD2 video playback panel by

ZEROXCLUB Instructions Manual

pressing the **CH** button.

Under the AHD1/AHD2 video playback panel, press **+☀/☀-** to select the video to be played and press **SEL** to confirm.

During video playback, press **+☀** to speed up playback, press **☀-** to rewind.

Note: Press **MODE** button to play/pause the recording video.

When in playback panel, press **MENU** to pop up the playback setting window, you can choose to delete file, protect file, switch back to the monitor page.

panel.

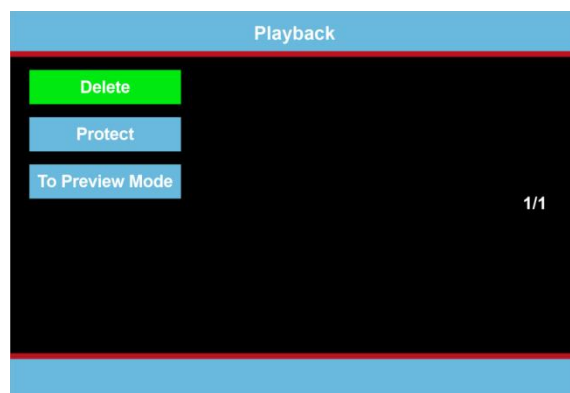

Delete: Delete one/ Delete All

Protect: Prevent accidental deletion of video files.

To Preview Mode: Exit the current panel

4.2 Still Quality

ZEROXCLUB Instructions Manual

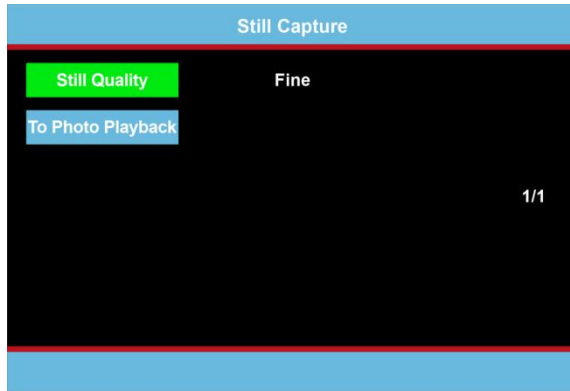

Press **MENU** → Go into the **Move Mode** → **SEL** → **+☀** (Skip to next option) **/-☀** (Back to the previous option) → **SEL** (confirm) → **+☀/-☀** (Increase/ decrease) → **Menu** (Back to the previous panel) → Until last complete set

(1) Still Quality: Super Fine/Fine

You can choose the quality of photo

(2) To Photo Playback: Same as “To Movie Playback”

4.3 Clock Settings

Change the Date and Time.

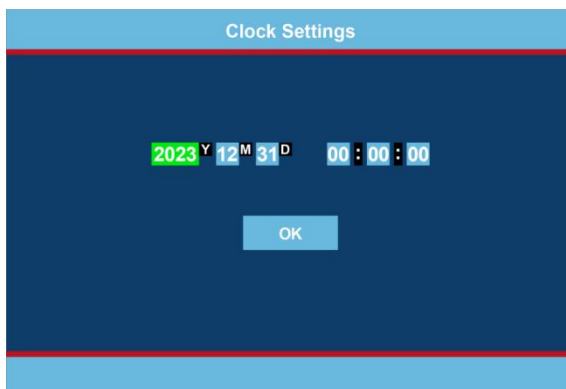

Press **MENU** → Go into the **Clock Settings** → **SEL** → **+☀/-☀** (Increase time/ decrease time) → **SEL** (confirm and go to the next

ZEROXCLUB Instructions Manual

date/time settings)→Until last complete set

NOTE: Press the MENU button once to return to the menu, press twice to return to the camera view.

NOTE: In this panel, the SEL button is a button that moves to next option.

4.4 Media Tool



Press **MENU** →Go into the **Media Tool**→**SEL**→+☀️/-☀️→Yes/No

Note: Make sure you have saved the important videos to the computer when you use this.

4.5 General Settings

More advanced display settings are available in the General Settings" panel.

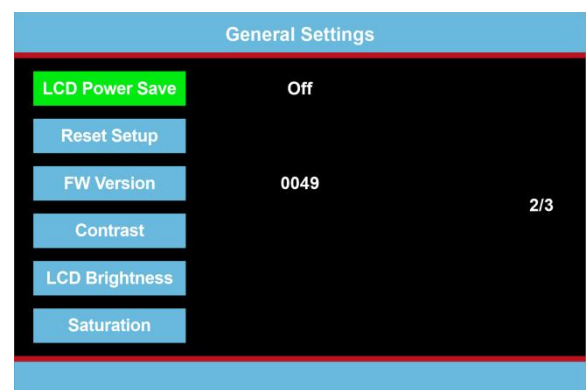
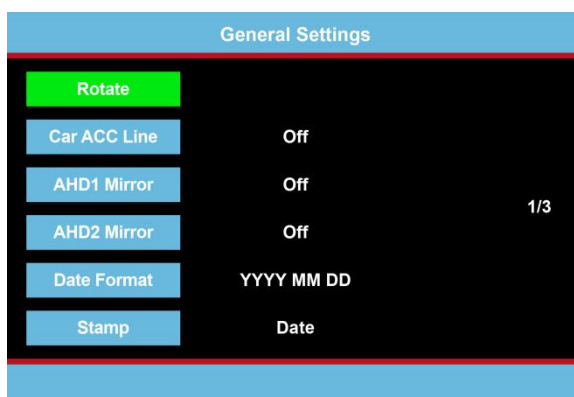

ZEROXCLUB Instructions Manual

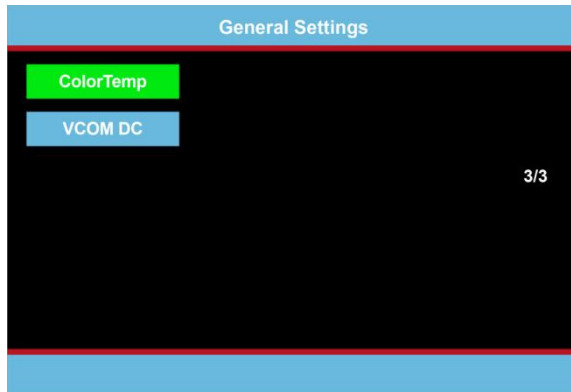

Press **MENU** → Go into the **General Settings** → **SEL** → **+☀** (Skip to next option) // **-☀** (Back to the previous option) → **SEL** (confirm)

(1) **Rotate**: This will rotate the image and the text will also rotate.

If you accidentally use it and flip the screen and text, please select this option and press the **SEL** button several times, it will return to the original normal screen.

(2) **Car ACC Line**: On/Off

NOTE: Only the AHD2 screen will be triggered for full screen with Parking Lines through Green wire.

NOTE: We recommend you connect the Green wire to the reverse light, then CH2 screen can be triggered with parking lines to help you reversing.

(3) **AHD1 Mirror**: On/Off

The AHD1 image can be set Mirrored with this function.

(4) **AHD2 Mirror**: On/Off

The AHD1 image can be set Mirrored with this function.

(5) **Date Format**: None/YYYY MM DD/ MM DD YYYY/ DD MM YYYY

(6) **Stamp**: This feature is not yet active, please ignore

ZEROXCLUB Instructions Manual

(7) **LCD Power Save:** Off/ 1min/ 3min

The screen will automatically turn off at the set time.

If set to 1 min, the monitor will standby after 1 minute when no operation is performed.

(8) **Reset Setup:** Yes/ No

If yes, all setting will be deleted

(9) **Contrast:** Adjust the Contrast to the desired level.

(10) **LCD Brightness:** Adjust the brightness to the desired level.

(11) **Saturation:** Adjust the Saturation to the desired level.

(12) **Color Temp:** Off, Warm, Cool. The default is Off

You can select the screen color temperature according to your habit

(13) **VCOM DC:**It can change the brightness of the screen. It is “40” by default. And we don’t recommend you to change this parameter.

4.6 Language

You can switch language to English/ Russian/ Chinese(Simplified)/ Chinese(Traditional)



ZEROXCLUB Instructions Manual

Press **MENU** → Go into the **Language Settings** → **SEL** → **+☀** (Skip to next option) // **-☀** (Back to the previous option) → **SEL** (confirm)

5.FAQ

(1) How to return interface while viewing the file?

A. 1. Automatically return to the playback panel after video playback ends.

2. Press the Menu button, then choose "**To Preview Mode**" and it will back to the monitor page.

(2) How to rotating the image ?

A. Menu-General Setting "Rotate" or "AHD1/AHD2 Mirror".

(3) How to record video?

A. Press the **SEL** button, then the red point will come that means the monitor recording.

(4) Why monitor can't use the menu and switch channel?

A. When you want to operate the screen buttons, make sure that the monitor does not stay in the recording state, and that the green cable is not triggered.

(5) What is the function of Trigger wire?

A. If you connect the trigger cable to the reversing light, the screen will automatically switch to the camera that connected to the reversing light when you reverse.

You don't need to manually switch to the camera channel.

ZEROXCLUB Instructions Manual

(6) How to find the SD card video on the computer?

A: Plug and play. Using a card reader that can read SD cards then plug it to your computer.

(7) How to view in split screen?

A.Press the **CH-** button

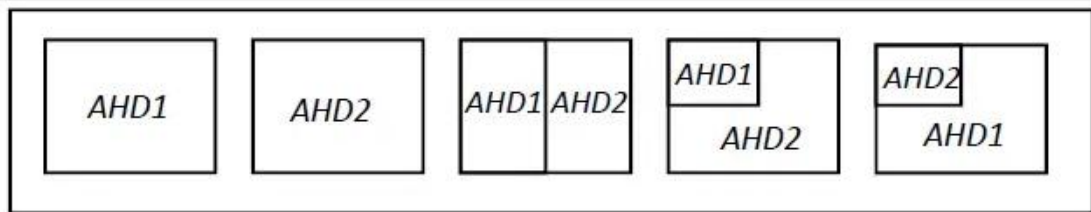

(8) What is the part number of the single camera?

A: The rear camera is B0BG7Z3Z47, and side camera is B0BG7Z3Z47

6.Troubleshooting

<p>The display will not turn on</p>	<ol style="list-style-type: none">1. Check 12v+ to monitor and check the display to ensure that it is powering. (the power indicator LED lights is on/off)2. Check if the power button on the display will turn on the light. and press the monitor's power button waiting 2-4 seconds then to see if there is any image?3. If use the DC power pigtaills cable, check if the positive and negative connections are reversed when
--	---

ZEROXCLUB Instructions Manual

	<p>connecting the red and black wires. If use the car charger, check this one is normal.</p> <ol style="list-style-type: none">4. Check ground connection. Ensure the cables and connections in your backup camera are firmly connected and not damaged5. Check the pins of the 4 pins cable of the camera if is aligned and broken. If the pins are awkward, you can gently straighten it,then the camera will work well.6. Check this product within the voltage range(12-24V) specified.7. Could you please check the camera that if get power? You can hold the sensor of the camera with your hand and see if the infrared light will light up.8. If it still can't work well after try, please contact us in time at sales@uszeroxclub.com with the picture of the issue and your Amazon Order ID.
Blurry camera	<ol style="list-style-type: none">1. Check the external lenses. Fix this by simply wiping off the dirt.2. Check if there any loose or faulty connections triggering such mishaps.3. There is moisture inside the camera's lenses, please contact us in time at

ZEROXCLUB Instructions Manual

	<p>sales@uszeroxclub.com with the picture of the issue and your Amazon Order ID.</p>
Have a problem with SD cards error	<p>Remove current micro SD card and installed a different micro SD card to see if the system has the same problem.</p> <p>If not, there may be a problem with the SD card. Please email us at sales@uszeroxclub.com for a replacement SD card.</p>
Blue on monitor screen	<ol style="list-style-type: none">1. Do a hard reset, unplug all cables, leave them out for 1 minute, and then re-connect them.2. Check to ensure that the connection to the camera is tight.3. Ensure camera cable is plugged into port labeled CH1/CH2.4. Ensure that the car charger or the red positive trigger on power pigtailed cable is put to power 12v+.5. If it still can't work well after try, please contact us in time at sales@uszeroxclub.com with your Amazon order ID and the issue picture, we will help you solve it.
The screen appears color cast or line	<ol style="list-style-type: none">1. Check the wiring firstly.2. If there is still no improvement, maybe the screen has been subjected to some collision during transportation or use,

ZEROXCLUB Instructions Manual

	<p>please contact us in time at sales@uszeroxclub.com with the picture of the issue and your Amazon Order ID</p>
The picture flashes frequently	<ol style="list-style-type: none">1. Check the wiring firstly, or change another camera for testing, or switch the screen for another viewing mode, to see whether it still flashes or not.2. Remove the micro SD card and see if there is flickering.3. Check if the voltage is stable and keep at 12V+4. If there is still no improvement, maybe power cord gets wrong during use, please contact us in time at sales@uszeroxclub.com with the picture of the issue and your Amazon Order ID
The monitor shows parking lines and the buttons can't work	<ol style="list-style-type: none">1. The monitor enters parking mode, please disconnect the Green wire for try. (Under parking mode, other buttons will be locked and can't be used for safety.)2. If it still can't work well, please contact us in time at sales@uszeroxclub.com with your Amazon Order ID

If you have any questions not mentioned above, just feel free to email us at sales@uszeroxclub.com. We're always there for you!

ZEROXCLUB Instructions Manual

7.Warranty

ZEROXCLUB offers a full 18 months warranty and replacement policy. We also provide lifetime technical support to ensure that you enjoy your modern backup camera for many years to come. To obtain warranty support, or if you are not satisfied in any way, or have any issues with your purchase, please contact us first for help, we will try our best to make you satisfied. We promise that you will receive the best service from us, and we will try our best to help you until your problem is solved. Every message will be replied to within 24h. Our contact email is sales@uszeroxclub.com, you can write it down or add it to your address book.

ZEROXCLUB

Customer Support email: sales@uszeroxclub.com