

Need Help?

✉: Support@treatlife.tech
Tech Support: www.treatlife.tech/pages/support



THANK YOU

If you have any questions, please feel free to contact us first. We are always here for you.

ATTENTION

- The Treatlife single pole light switch can only replace existing single pole light switches.
- Neutral wire is required to install the smart switch. If your house was built or remodeled before mid-80's, you may not have a neutral. Please try another location or call an electrician for help.
- Install your Treatlife where there is a strong Wi-Fi signal.
- Keep your mobile device close to the Treatlife light switch until setup is complete.
- The supported maximum wattage rating is: 1250W.

The Tools You'll Need

- Screwdriver
- Pliers
- Electrical Tester

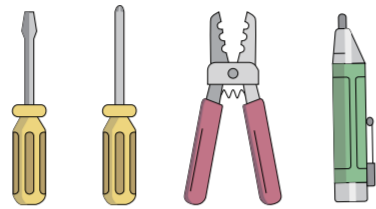

1. Turn Off Power

Locate your circuit breaker panel and turn off the power to each switch you are replacing



Caution:

Risk of shock. Make sure the power to every switch you are replacing has been turned off before installation. Please call a professional electrician if you are not familiar with electrical work.

2. Verify Power Is Off

Press each light switch at the location you're doing the installation to confirm the power is off. If a light turns on, return the panel to turn off the correct circuit. We recommend you to remove the faceplate from the old switch and use electrical tester to test all wires connected to the switch to ensure there is no voltage in the circuit.

You may need to turn off more than one circuit breaker.

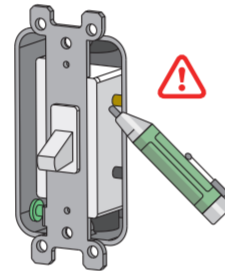

3. Pull Out Old Switch

Unscrew the old switch and pull it out of the wall. Do not remove any wires.

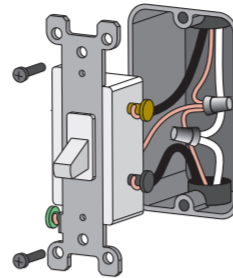

4. Find the NEUTRAL Wires

A neutral is required to install the smart light switch. Make sure there are NEUTRAL wires (most likely a bundle of one or more white wires) in the wall. Unless you are replacing an existing smart switch, it's probably not connected to your old switch.

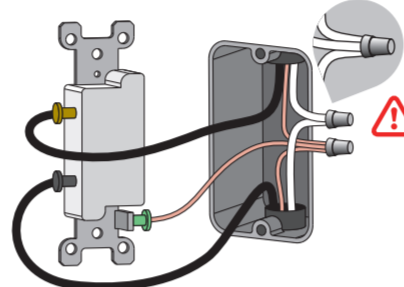

Note: If there is no neutral, please try another location or call an electrician for help.

5. Test NEUTRAL and GROUND Wires

Make sure there is no power on the neutral wires from a neighboring circuit. If necessary, shut off the additional circuits until no voltage is found.

- Label the NEUTRAL and GROUND wire in the wall with the stickers in the package. GROUND wires are usually BARE COPPER or GREEN.

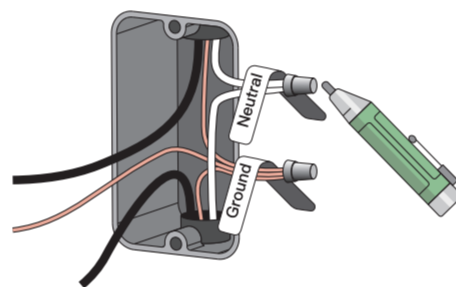

6. Identify Line and Load Wire

Label the LINE wire in the wall with the "Line" sticker. Label the LOAD wire in the wall with the "Load" sticker.

How to identify Line and Load?

- Turn on the power and make sure that the switch is off. If not, please turn off the switch and turn off the light. (Be careful not to touch any wires)
- Use an electrical tester to measure the two wires (usually black) connected to the old switch, the Line and Load can be identified according to the measurement method of the electrical tester. (The tester will flash or chirp when it comes close to a Line wire)

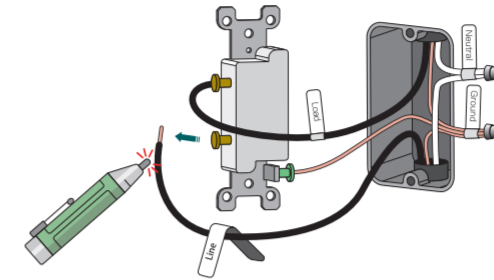

Note: If the Line and Load wires are reversely connected, the switch will not work.

7. Take Pictures of the Wiring

Take one or two pictures of the old switch and where each wire is connected to it, in case you need guidance to repeat the installation.

Note: Make sure all of the text on the labels in the pictures is clearly displayed.

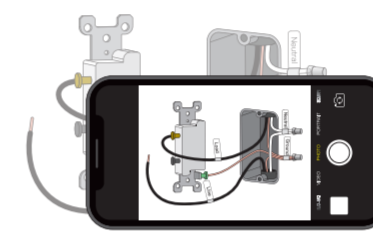

8. Remove Existing Switch

Loosen the screw terminals and remove the old switch.

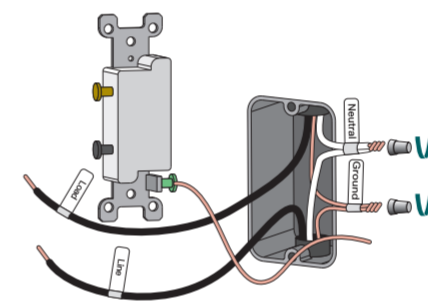

9. Wire the Smart Switch

Remove the sticker securing the wires on the new switch.

- Connect NEUTRAL/GROUND Wires. Use wire nuts to connect the neutral and ground wires on the Treatlife Light Switch to the labeled wires coming from the wall in order.
- Connect LINE/LOAD Wires. Use wire nuts to connect the line and load wires on the Treatlife Light Switch to the labeled wires coming from the wall in order.

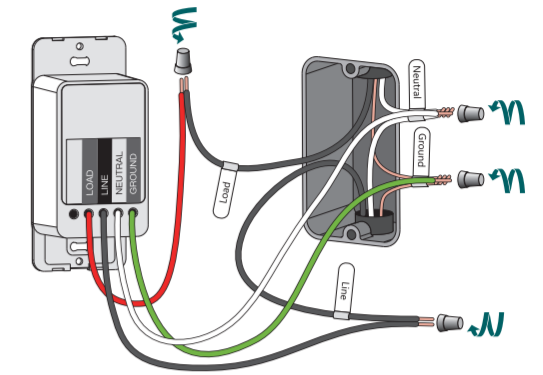

10. Install Light Switch Into the Wall

Hold the wire nuts and gently pull each wire to make sure the wire nuts are secure. Carefully push the wires deep into the switch box. Attach the Light Switch to the switch box with the screws provided. Finally, snap on the faceplate.

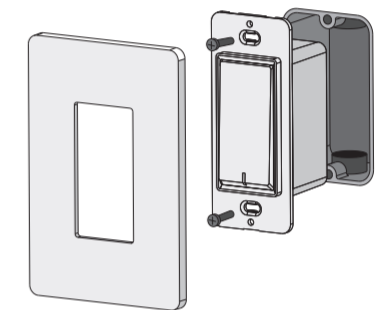

Note: Do not over tighten the screws, as it could restrict the operation of the switch.

11. Turn on Power

Turn the power back on at the circuit breaker.

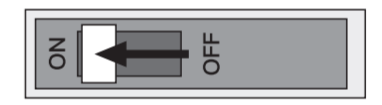

- Press the on/off button to confirm whether the switch is powered on/off normally. If the light fixture can not be turned off/on, the wiring may be incorrect or the nuts are loose. (In this case, the most likely problem is that the line and load wires are reversely connected.) Please refer to the instructions in the manual or call an electrician for help.

If you encounter any problems, please contact us via email: Support@treatlife.tech (Please be sure to attach the wiring pictures of the old switch in step 7)

ADD DEVICES

1. Download the TreatLife APP



Please scan the QR code or search "TreatLife" on the Apple APP Store / Google Play to download the APP.

2. Registration or Log In

- Tap "Register" to create an account. Enter your Email Address to get a verification code and create a password. Or, choose "Log in" if you already have a TreatLife account.

3. Configure the APP to the Switch

- Preparation: Ensure the switch is connected to power; Ensure your phone is connected to your WiFi router and is able to connect to the internet.

Note: This switch only supports 2.4Ghz networks. If you connected to a 5Ghz network before, please switch to the 2.4Ghz Network

3.1 Bluetooth Mode (Automatic Mode)

- First, turn on the phone's Bluetooth.
- Switch in the device and ensure it is receiving power.
- Press and hold the mechanical on/off button for 5 seconds until the red indicator light blinks rapidly.
- Open the "TreatLife" APP and it will find the Treatlife switch automatically.
- If the switch is not automatically discovered, click the "+" at the top right list and select Auto Scan to automatically search for the switch.
- Follow the steps in the APP to complete the pairing.

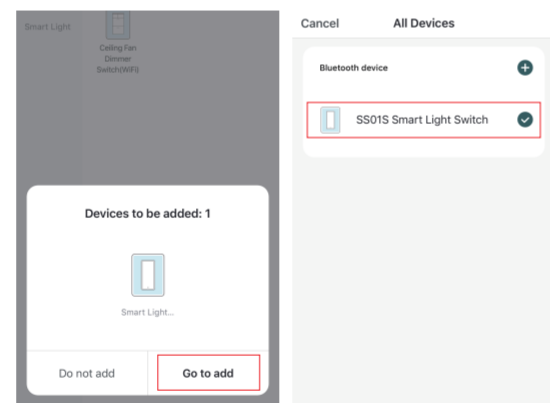

3.2 Default Configuration Mode

- Tap the icon "+" on the top right corner to select device type; Tap "All" and choose "Dimmer Switch(WiFi)".
- Press and hold the mechanical on/off button for 5 seconds until the red indicator light blinks rapidly.
- Tap "Confirm indicator rapidly blink"; Enter your WiFi password; Wait for the switch to complete.
- Repeat steps to add any additional smart switches.

3.3 AP Mode

- If you can not configure the switch successfully with the default mode, please try to connect with AP Mode.
- Tap "AP Mode" on the top right corner.
- Press and hold the mechanical on/off button for 5 seconds, until the red indicator light blinks slowly.
- Tap "Confirm indicator slowly blink".
- Enter your Wi-Fi password.
- Open WLAN settings; The Wi-Fi settings on your phone and connect to the "TreatLife-XXX" network.
- Go back to the APP and continue to add the device then wait for the connection to complete.

Link TreatLife to Alexa/Google Assistant

Go to TreatLife> >More for instructions to link Alexa/Google Assistant.

Note: Please log in with your TreatLife account.

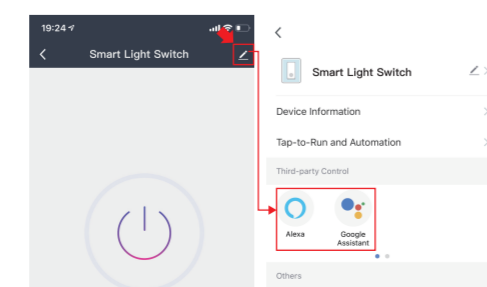

Key Steps to Link the Alexa Skill

- Sign in with Amazon, tap on "Skills & Games" in the Alexa menu;
- Search for the "TreatLife", and tap "Enable" to enable the Skill.
- Enter the "TreatLife" APP Account and Password, then tap "Link Now" to enable the Skill.

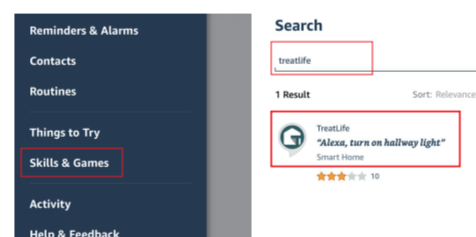

PRODUCT APPEARANCE

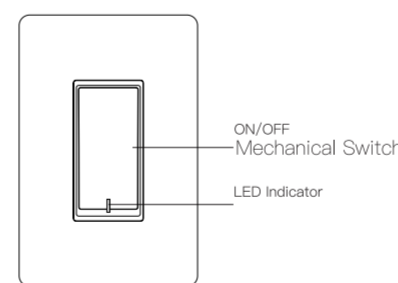

Indicator Light Status

Light Color	Light Status	Switch Status
White	ON	Power OFF
	OFF	Power ON
Red	Steady on	Energy-saving mode
	Blinking rapidly (twice/1s)	Ready for default configuration mode / Ready for Bluetooth mode
	Blinking slowly (once every 3s)	Ready for AP(Access Point) configuration mode
	Turn on for 10s and then turn off	Configured successfully but the network disconnects suddenly

TROUBLESHOOTING

Can't connect to the APP.

- Please make sure the red indicator light is blinking when you are attempting to connect to the APP. Default Mode Pairing: Red Indicator Blinking rapidly. AP Mode Pairing: Red Indicator Blinking slowly.
- Please finish the pairing within 3 minutes when the red indicator starts blinking. (Refer to "Me-FAQ& Feedback" in the APP)

- If your router is 2.4Ghz & 5Ghz dual-band, the 2.4Ghz band may not be turned on. Please enter the router settings to turn on the 2.4Ghz band. You can check the router's manual or contact the router's official support for help.
- Make sure you entered the correct WiFi password.

The smart switch shows wrong status in the APP.

- The network may be delayed or the signal is weak. Please move the router closer to the switch or power off the router and then on. If it still doesn't work, try to replace the light bulb with a different model / brand.

Can't connect to Alexa.

- Check whether the Alexa APP is correctly configured with the account of TreatLife APP. Refer to the manual instruction or check "Me-FAQ& Feedback-All-Third-party control issues" in the APP for help.

The Timing function doesn't work properly.

- Remove the switch from APP, and repair the switch to app again; You can also check Me-> FAQ & Feedback information in the APP.

APP/Alexa is out of sync with light status.

- The network may be delayed or the signal is weak, you can try to move the router closer and restart the router.

The smart switch is turned on or off for no reason.

- Please try to power off the switch for a few minutes and then power on, if it still can not be solved, please provide the Virtual ID in the APP to us.

After using the switch for a period of time, manual operation doesn't work properly.

- Press the restart button or power off the switch for a few minutes and then power it on again.

One of several Treatlife light switches doesn't work properly.

- Replace this switch with one of the known good ones to ensure everything is wired properly. If it still doesn't work, please contact our support.

FCC Caution:

This device complies with part 15 of the FCC Rules. Operation is subject to the following two conditions: (1) This device may not cause harmful interference, and (2) this device must accept any interference received, including interference that may cause undesired operation.

Any Changes or modifications not expressly approved by the party responsible for compliance could void the user's authority to operate the equipment.

Note: This equipment has been tested and found to comply with the limits for a Class B digital device, pursuant to part 15 of the FCC Rules. These limits are designed to provide reasonable protection against harmful interference in a residential installation. This equipment generates uses and can radiate radio frequency energy and, if not installed and used in accordance with the instructions, may cause harmful interference to radio communications. However, there is no guarantee that interference will not occur in a particular installation. If this equipment does cause harmful interference to radio or television reception, which can be determined by turning the equipment off and on, the user is encouraged to try to correct the interference by one or more of the following measures:

- Reorient or relocate the receiving antenna.
- Increase the separation between the equipment and receiver.
- Connect the equipment into an outlet on a circuit different from that to which the receiver is connected.
- Consult the dealer or an experienced radio/TV technician for help.

RSS (Category I Equipment):

This device complies with Innovation, Science, and Economic Development Canada's licence-exempt RSS standard(s). Operation is subject to the following two conditions:

- (1) this device may not cause interference, and
 - (2) this device must accept any interference, including interference that may cause undesired operation of the device.
- Le présent appareil est conforme aux CNR d'Innovation, Sciences et Développement économique Canada applicables aux appareils radio exempts de licence. L'exploitation est autorisée aux deux conditions suivantes :
- (1) l'appareil n'est pas autorisé à produire de brouillage, et
 - (2) l'utilisateur de l'appareil doit accepter tout brouillage radioélectrique subi, même si le brouillage est susceptible d'en compromettre le fonctionnement.

The device is compliance with RF exposure guidelines, users can obtain Canadian information on RF exposure and compliance. The minimum distance from body to use the device is 20cm. Le présent appareil est conforme

Après examen de ce matériel aux conformités ou aux limites d'intensité de champ RF, les utilisateurs peuvent sur l'exposition aux radiofréquences et la conformité et compliance d'acquiescer les inf corps à utiliser le dispositif est de 20cm.