

**USER MANUAL  
DS02**

**Need Help?**  
✉: Support@treatlife.tech  
Tech Support: www.treatlife.tech/pages/support



**THANK YOU**  
If you have any questions, please feel free to contact us first. We are always here for you.

**ATTENTION**

- The Treatlife 3-way dimmer switch can replace existing 3-way or single-pole light switches.
- When this device is used as a 3-way switch, it can only be used with traditional ordinary 3-way switch.
- This device needs to be installed at the input end of the 3-way line (usually close to the distribution box).

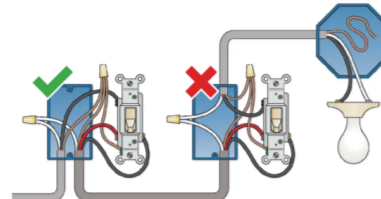

- Supported Bulb Types: Dimmable LED/CFL – 150W Max; Incandescent – 400W Max. Not compatible with non-dimmable light bulbs.
- Neutral wire is required to install the smart switch. If your house was built or remodeled before mid-80's, you may not have a neutral. Please try another location or call an electrician for help.
- Install your Treatlife switch where you there is a strong Wi-Fi signal.
- Keep your mobile device close to the Treatlife switch until setup is complete.

**The Tools You'll Need**

- Screwdriver
- Pliers
- Electrical Tester

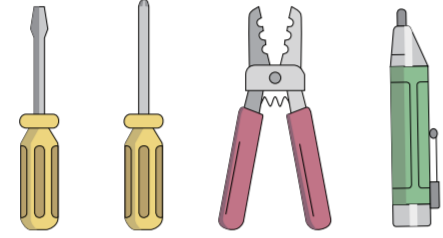

**1 Turn Off Power**

Locate your circuit breaker panel and turn off the power to each switch you are replacing.

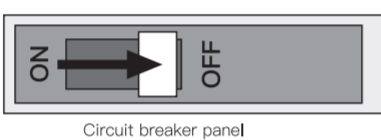

**Caution:**  
Risk of shock. Make sure the power to every switch you are replacing has been turned off before installation. Please call a professional electrician if you are not familiar with electrical work.

**2 Verify Power Is Off**

- If this device is used as a 3-way switch, please select the input end of the 3-way line (usually close to the distribution box).
- Press each light switch at the location you're doing the installation to confirm power is off. If a light turns on, return the panel to turn off the correct circuit. We recommend you to remove the faceplate from the old switch and use an electrical tester to test all wires connected to the switch to ensure there is no voltage in the circuit.
- You may need to turn off more than one circuit breaker.

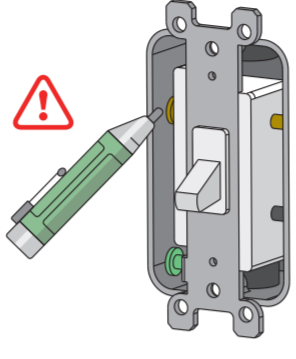

**3 Pull Out Old Switch**

Unscrew the old switch and pull it out of the wall. Do not remove any wires.

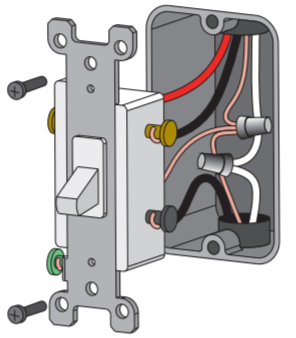

**4 Identify the Old Switch**

**A Single-pole Switch**  
Only one switch controls one light or a bundle of lights.

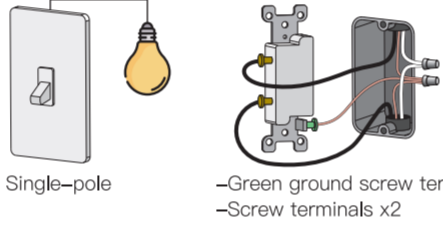

Single-pole  
-Green ground screw terminal x1  
-Screw terminals x2

**B.3-Way Switch**  
Two switches control the same light or the same bundle of lights.

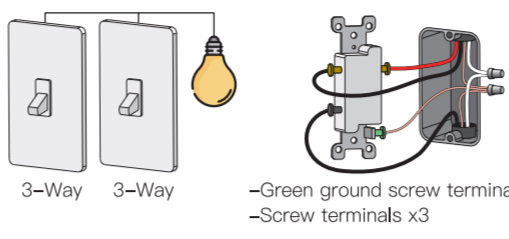

3-Way 3-Way  
-Green ground screw terminal x1  
-Screw terminals x3

**C.4-Way Switch**  
If three switches control the same light or the same bundle of lights, one of the switches is a 4-way switch. The other two are 3-way switches.

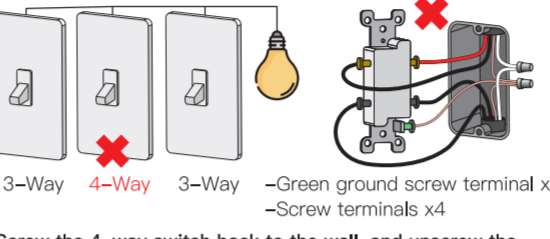

3-Way 4-Way 3-Way  
-Green ground screw terminal x1  
-Screw terminals x4

Screw the 4-way switch back to the wall, and unscrew the 3-way switches on the circuit that close to the distribution box.

**5 Identify Whether the Switch Is at the Input**

- Turn on the power, turn off the switch. (Note: Do not touch the switch circuit or screws with your hand during the process)
- Use an electrical tester to detect the black screw on the old switch. (For the identification method, please refer to the electrical tester manual)
- If the detection result is not line wire, this position is the output, the switch is not suitable for this position. Please turn off the power, reinstall the old switch to the wall, and reselect the other end switch for replacement.
- If the detection result is line wire, this position is the input, and it is the correct replacement position. Please turn off the power, and proceed to the next operation.

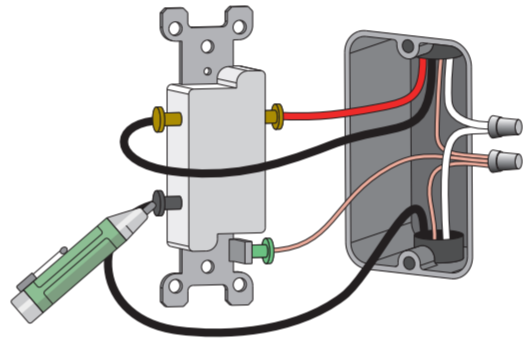

**6 Find the NEUTRAL Wires**

A neutral is required to install the smart light switch. Make sure there are NEUTRAL wires (most likely a bundle of one or more white wires) in the wall. Unless you are replacing an existing smart switch, it's probably not connected to your old switch.

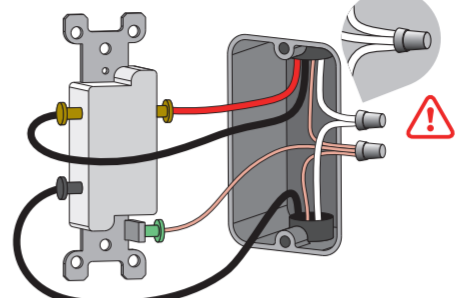

**Note: If there is no neutral, please try another location or call an electrician for help.**

**7 Test NEUTRAL and GROUND Wires**

Make sure there is no power on the neutral wires from neighboring circuit. If necessary, shut off additional circuits until no voltage is found.

- Label the NEUTRAL and GROUND wire in the wall with the stickers in the package.
- GROUND wires are usually BARE COPPER or GREEN.

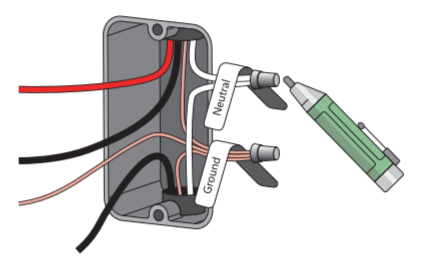

**8 Identify Line/Load Wire**

**Note: The color of your wire may be different from the color shown on the manual.**

**A Single Pole Only**

- Label the remaining two wires in the wall with the two "Line/Load" stickers in the package.

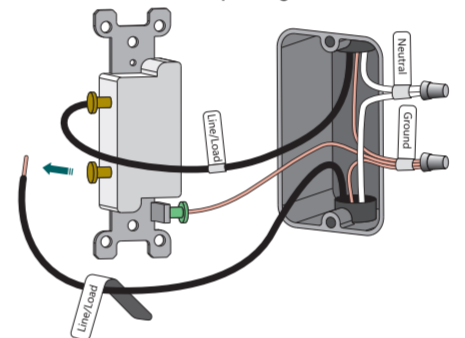

**B 3-Way Only**

- Label the LINE/LOAD wire (usually BLACK, attached with a black screw, and may be labeled "common") in the wall with the "Line/Load" sticker.
- Label the remaining two wires with the "Traveler" stickers in the package.

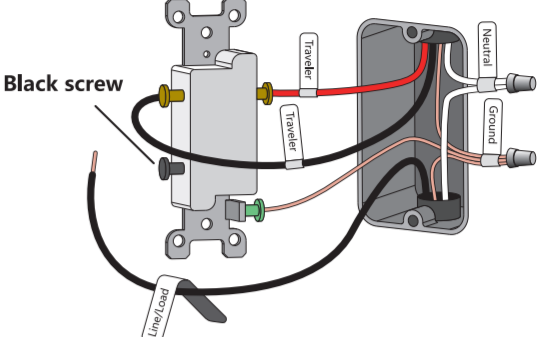

**9 Take Pictures of the Wiring**

Take one or two pictures of the old switch and where each wire is connected to it, in case you need guidance to repeat the installation.

**Note: Make sure all of the text on the labels in the pictures is clearly displayed.**

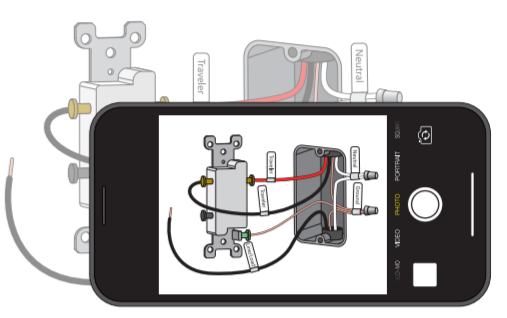

**10 Remove Existing Switch**

Loosen the screw terminals and remove the old switch.

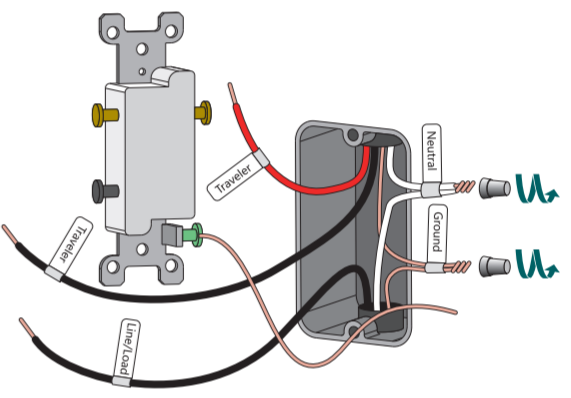

**11 Wire the Smart Switch**

Remove the sticker securing the wires on the new switch.

**A Single Pole Only**

- Connect NEUTRAL/GROUND Wires**  
Use wire nuts to connect the neutral and ground wires on the Treatlife Light Switch to the labeled wires coming from the wall in order.
- Connect LINE/LOAD Wires**  
Use a wire nut to connect the LINE/LOAD wire from Treatlife Light Switch to one of the labeled "Line/Load" wires coming from the wall.  
Use a wire nut to connect one of the TRAVELER wires from Treatlife Light Switch to the LINE/LOAD wire coming from the wall.  
Cap off the remaining TRAVELER wire from the Switch with a wire nut.

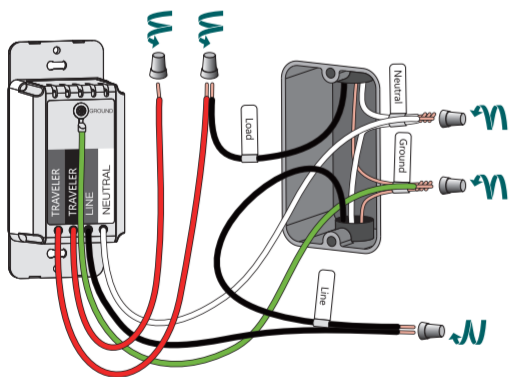

**B 3-Way Only**

- Connect NEUTRAL, GROUND, LINE/LOAD Wires**  
Use wire nuts to connect these different wires from Treatlife Light Switch to the labeled wires coming from the wall.
- Connect TRAVELER Wires**  
Use wire nuts to connect the RED wires from the Switch to the TRAVELER wires coming from the wall.

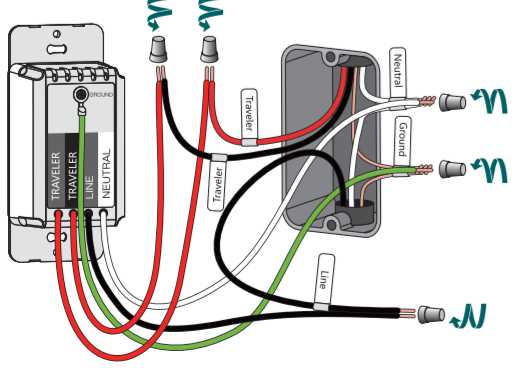

**12 Install Light Switch Into the Wall**

Hold the wire nuts and gently pull each wire to make sure the wire nuts are secure. Carefully push the wires deep into the switch box. Attach the Light Switch to the switch box with the screws provided. Finally, snap on the faceplate.

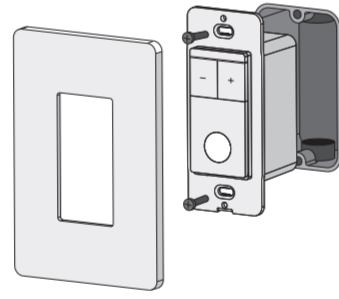

**Note: Do not over tighten the screws, as it could restrict the operation of the switch.**

**13 Turn on Power**

Turn power back on at the circuit breaker.

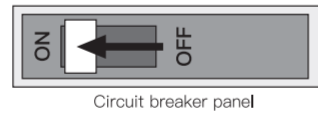

Press the on/off button to confirm whether the switch is powered on/off normally. If the light fixture can not be turned off/on, or sometimes the light switch can not be turned on or off, the wiring maybe incorrect or the nuts are loose. Please refer to the instructions in the manual or call an electrician for help.

**If you encounter any problems, please contact us via email: Support@treatlife.tech (Please be sure to attach the wiring pictures of the old switch in step 9)**

**PRODUCT APPEARANCE**

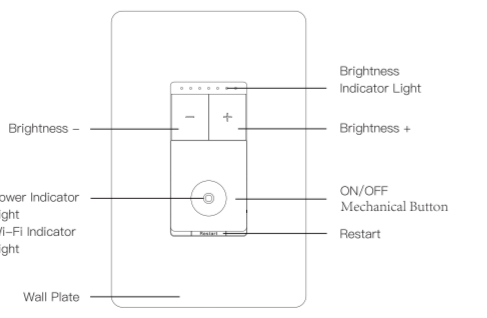

**Indicator Light Status**

Light Color	Light Status	Switch Status
White	ON	Power OFF
	OFF	Power ON

	Steady on	Energy-saving mode
Red	Blinking rapidly (twice/1s)	Ready for default configuration mode
	Blinking slowly (once/3s)	Ready for AP(Access Point) configuration mode
	Turn on for 10s and then turn off	Configured successfully but the network disconnects suddenly

**ADD DEVICES**

**1. Download the TreatLife APP**



Please scan the QR code or search "TreatLife" on the Apple APP Store / Google Play to download the APP.

**2. Registration or Log In**

- Tap "Register" to create an account. Enter your email address to get a verification code and create a password. Or, choose "Log in" if you already have a TreatLife account.

**3. Configure the APP to the Switch**

- Preparation: Ensure the switch is connected to power; Ensure your phone is connected to your WiFi router and is able to connect to the internet.

**Note:**  
This switch only supports 2.4GHz networks. If you connected to a 5GHz network before, please switch to the 2.4GHz Network.

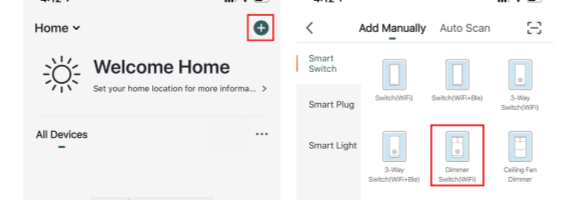

**3.1 Default Configuration Mode**

- Press and hold the mechanical on/off button for 5 seconds until the red indicator light blinks rapidly.
- Tap "Confirm indicator rapidly blink"; Enter your WiFi Password; Wait for the switch to complete.
- Repeat steps to add any additional smart switches.

**3.2 AP Mode**

- If you can not configure the switch successfully with the default mode, please try to connect with AP Mode.

- Tap "AP Mode" on the top right corner.
- Press and hold the mechanical on/off button for 5 seconds, until the red indicator light blinks rapidly. Then press and hold for 5 seconds again until the indicator light blinks slowly.
- Tap "Confirm indicator slowly blink".

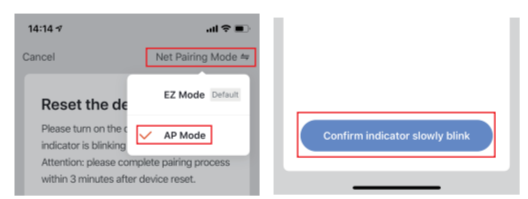

Enter your Wi-Fi Password.

- Open WLAN settings; the Wi-Fi settings on your phone and connect to the "TreatLife-xxx" network.
- Go back to the APP and continue to add the device then wait for the connection to complete.

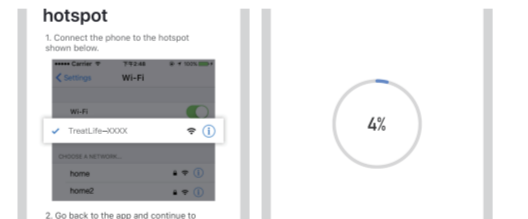

**Link TreatLife to Alexa/Google Assistant**

- Go to TreatLife > More for instructions to link Alexa/Google Assistant.

**Note: Please log in with your TreatLife account.**

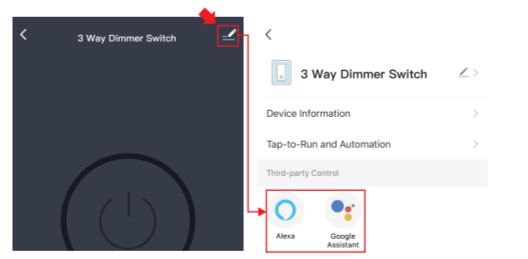

**Key Steps to Link the Alexa Skill**

- Sign in With Amazon, tap on "Skills & Games" in the Alexa menu;
- Search for the "Smart Life", and tap "Enable" to enable the Skill.
- Enter the "TreatLife" APP Account and Password, then tap "Link Now" to enable the Skill.

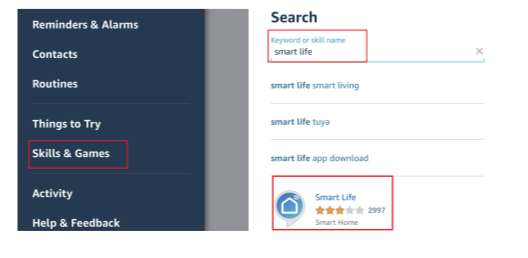

**TROUBLESHOOTING**

Can't connect to the APP.

- Please make sure the red indicator light is blinking when you are attempting to connect to the APP. Default Mode Pairing: Red Indicator Blinking rapidly, AP mode Pairing: Red Indicator Blinking slowly.
- Please finish the pairing within 3 minutes when the red indicator starts blinking. (Refer to "Me-FAQ&Feedback" in the APP)
- If your router is 2.4GHz & 5GHz dual-band, the 2.4GHz band may not be turned on. Please enter the router settings to turn on the 2.4GHz band. You can check the router's manual or contact the router's official support for help. Make sure you entered the correct WiFi password.

The smart switch shows the wrong status in the APP.

- The network may be delayed or the network signal is weak. Try to move the router closer to the switch or power off the router and then power it on. If it still doesn't work, try to replace the light bulb with a different model or brand bulb.

Can't connect to Alexa.

- Check whether the Alexa APP is correctly configured with the account of TreatLife APP. Refer to the manual instruction or "Me-FAQ&Feedback" in the APP.
- Third-party control issues" in APP to reconnect to Alexa.

The Timing function doesn't work properly.

- Remove the switch from APP, and repair the switch to APP again; You can also check Me-> FAQ & Feedback information in the APP. If it still doesn't work, please provide the Virtual ID in the APP to us.

Can't dim lights manually.

- Check if they are dimmable light bulbs, if not, change to another non-smart dimmable light bulb.

There is a noise with the light switch or light bulb.

- Change to another different model of non-smart dimmable light bulb.

Lights are too bright even on minimum level.

- Go to TreatLife > dimmer setting to decrease the dimming range.

Lights are too dark or not light up even on minimum level.

- Go to TreatLife > dimmer setting to increase the dimming range.

Lights Flickering.

- If they are dimmable light bulbs, go to TreatLife > dimmer setting to switch the mode or adjust the dimming range; If they are not dimmable light bulbs, change to non-smart dimmable light bulbs. Wires not secured firmly with wire connectors.

After turning off the light, the light bulb flickers or is not completely turned off.

- Replace the light bulb with a different make/model.

After using the switch for a period of time, manual operation doesn't work properly.

- Turn off the power at your circuit breaker panel for a few minutes and then power it on again.

One of several Treatlife light switches doesn't work properly.

- Replace this switch with one of the known good ones to ensure everything is wired properly. If it still doesn't work, please contact our support.

**FCC Caution:**

This device complies with part 15 of the FCC Rules. Operation is subject to the following two conditions: (1) This device may not cause harmful interference, and (2) this device must accept any interference received, including interference that may cause undesired operation.

Any Changes or modifications not expressly approved by the party responsible for compliance could void the user's authority to operate the equipment.

Note: This equipment has been tested and found to comply with the limits for a Class B digital device, pursuant to part 15 of the FCC Rules. These limits are designed to provide reasonable protection against harmful interference in a residential installation. This equipment generates uses and can radiate radio frequency energy and, if not installed and used in accordance with the instructions, may cause harmful interference to radio communications. However, there is no guarantee that interference will not occur in a particular installation. If this equipment does cause harmful interference to radio or television reception, which can be determined by turning the equipment off and on, the user is encouraged to try to correct the interference by one or more of the following measures:

- Reorient or relocate the receiving antenna.
- Increase the separation between the equipment and receiver.
- Connect the equipment into an outlet on a circuit different from that to which the receiver is connected.
- Consult the dealer or an experienced radio/TV technician for help.

**RSS (Category I Equipment):**

This device complies with Innovation, Science, and Economic Development Canada's licence-exempt RSS standard(s). Operation is subject to the following two conditions: (1) this device may not cause interference, and (2) this device must accept any interference, including interference that may cause undesired operation of the device.

Le présent appareil est conforme aux CNR d'Innovation, Sciences et Développement économique Canada applicables aux appareils radio exempts de licence. L'exploitation est autorisée aux deux conditions suivantes:

- l'appareil ne doit pas produire de brouillage, et
- l'utilisateur de l'appareil doit accepter tout brouillage radioélectrique subi, même si le brouillage est susceptible d'en compromettre le fonctionnement.

The device is compliance with RF exposure guidelines, users can obtain Canadian information on RF exposure and compliance. The minimum distance from body to use the device is 20cm.

Le présent appareil est conforme

Après examen de ce matériel aux conformités ou aux limites d'intensité de champ RF, les utilisateurs peuvent sur l'exposition aux radiofréquences et la conformité et compliance d'acquiescer les informations correspondantes. La distance minimale du corps à utiliser le dispositif est de 20cm.