

iSteadyPro 3

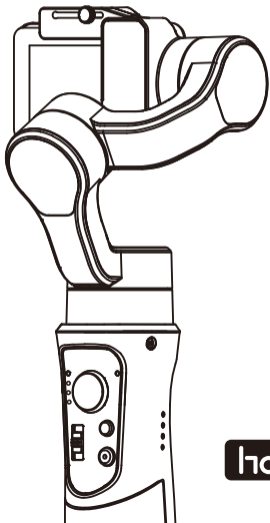

@ Hohem-Tech
Get more tutorial video



hohem

EN	3 - Axis Stabilizing Gimbal for Action Camera User Guide -----1-14
JP	三軸アクションカメラ用ハンドヘルドスタビライザー クイックスタートガイド -----15-28
DE	Stabiler Gimbal mit 3 Achsen für Action Kamera Bedienungsanleitung -----29-42
IT	Sospensione cardanica stabilizzatore palmare a 3 assi per la camera d'azione Guida dell'utente -----43-56
FR	Stabilisateur Portable à 3 axes pour Caméra d'Action Guide de L'Utilisateur -----57-70
ES	Gimbal estabilizador de mano de 3 ejes para cámara de acciónGuía para Usuario-----71-84

DISCLAIMER

- Please use the product in accordance with the user guide.
 - Make sure your camera device is mounted before powering on the gimbal.
 - Keep the gimbal away from fire and heat source.
 - Prohibiting the product to be used for any illegal purpose. The user who violates the regulation will be responsible for all the consequences by purchasing and using the product.
 - For any products which comes from non-normal source, we will not be at any service.
 - For any question, please contact the technical support of Hohem Tech. We will be always at your service to provide the technical support and advice for any improper using of gimbal.
 - Hohem Tech reserves the right of final explanation.
-



Hohem Technology Co., Ltd



Tel: +86-755-86573216

Email: service@hohem.com

Web: www.hohem.com

Addr: B106, University Creative Park, Xili, Nanshan, Shenzhen, 518055, P.R. China

Product Overview

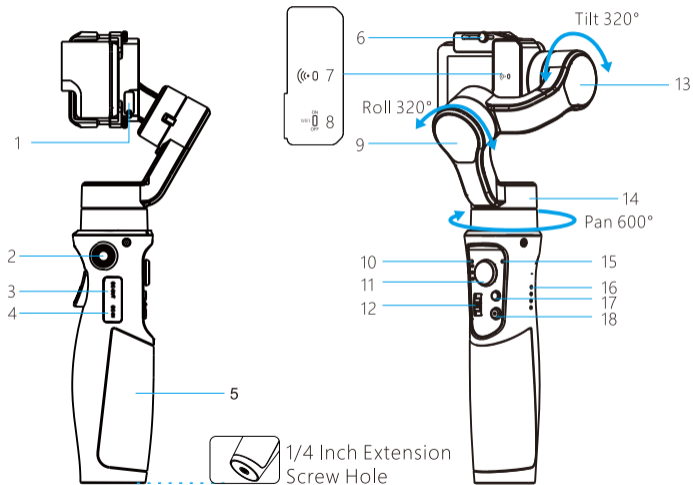

- | | | |
|----------------------------------|------------------------|--------------------------------|
| 1. Mini USB DC out Port | 7. WiFi Indicator | 13. Tilt Motor |
| 2. 1/4 Inch Extension Screw Hole | 8. WiFi Control ON/OFF | 14. Pan Motor |
| 3. Trigger Button | 9. Roll Motor | 15. Bluetooth Light |
| 4. USB DC Out/ DC In | 10. Mode Light | 16. Power Indicator Light |
| 5. Handle (Battery inside) | 11. Joystick | 17. Mode Button |
| 6. Thumb Screw | 12. Slider | 18. ON/OFF
(Shutter button) |

· Accessories List

Mini Tripod*1	User Manual*1
USB C able*1	Charging Cable*1
Carry Case*1	

Download APP—Hohem Gimbal



- * Scan QR code to download the app.
- * Hohem Gimbal supports iOS 9.0 and Android 5.0 or above.
- * Search for 'Hohem Gimbal' in the App Store or Google Play and follow the instructions to install the app.



Quick Start

A. Charge the battery

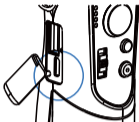

B. Mounting actioncam

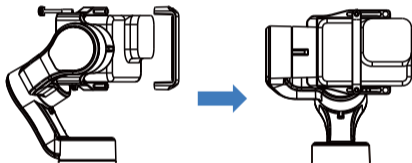

C. Power on

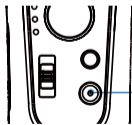

Long press the power button for 3 secs to turn on the gimbal.

Gimbal Charging

Charge the gimbal fully before using it for the first time.

- * USB Port: Power bank output
- * Micro USB Port: Gimbal charging port

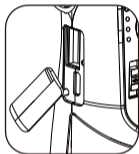

- * Mini USB DC out Port: Actioncam charging port

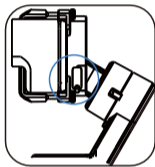

(It can be enabled
in the App Setting
-Camera options
-Charging Function)

* Tap the power button to check the battery status

- 4 LED lights on: 100%
- 3 LED lights on: 75%
- 2 LED lights on: 50%
- 1 LED light on: 25%



- * Indicator Lights blink:
Charging in process
- * 4 LED light on: Fully charged

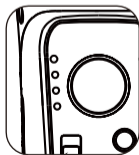

Low battery warning:
Mode light blinks back
and forth

Mounting the Actioncam

* Do not turn on the gimbal without a actioncam mounted on.

Put the tilt motor to the LEFT side, place action camera closely to the back clip as picture and tighten the knob to secure its position. Double tighten by 2 long screws against violent movement.

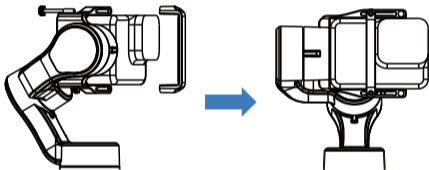

*Max Payload: 150g

*The camera holder supports the max. width of actioncam 48 mm, max. thickness 32mm.

*Supported cameras: GoPro Hero 8/ 7/6/5/4/3, DJI OSMO Action, SONY RX0, YI, SJCAM, and other action camera with similar size and weight.

How to connect GoPro?



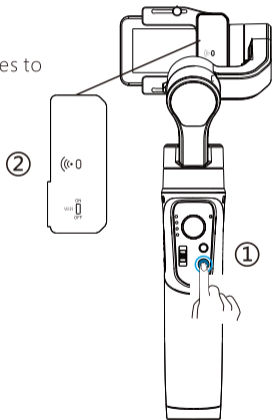

iSteady Pro 3 is able to connect GoPro Hero 8/7/6/5/4.

1. Power on the gimbal.
 2. Turn on the WiFi Control, the WiFi indicator flashes to wait the gimbal to connect GoPro.
 3. Turn on GoPro and enter the CONNECT, click "Smart Remote" for connection.
 4. The WiFi indicator will be solid green once connected successfully.
- Turn off the WiFi control when you do not want to connect GoPro, to save the battery of gimbal.
 - GoPro will be automatically connected after turn on the WiFi control again.

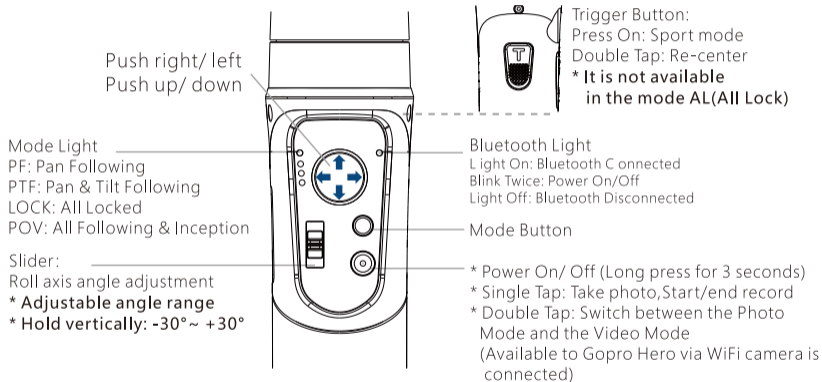

Operation Instruction



Mode Button	Working Mode (Mode Light)	Schema	Instruction
Tap the button to switch different working modes with light on	PF Pan Following		Default mode, tilt & roll axis both locked, camera is able to move to left or right smoothly.
	PTF Pan& Tilt Following		Roll axis locked, camera is able to move to left/right, and tilt up/down.
	AL All Locked		The camera stays in its current orientation.
	POV All Following& Inception		Tilt axis, roll axis and pan axis all follow.
Long Press for 6 Seconds	Calibration Mode (Light on)		It requires to calibrate the gimbal only when you notice any kind of not level or drift on any of the axes.

App "Hohem Gimbal" Instruction

Bluetooth Connection

- A. Enable the Bluetooth on the smartphone.
- B. Open the app, choose the product model and confirm into Bluetooth connection.
- C. Make sure the gimbal indicator keeps on.

Main App Functions

1. Home
2. Bluetooth
3. Power Status
4. Axis angle display in sync
5. Motion Timelapse
6. Re-center
7. Remote Control
8. Switch Work Mode

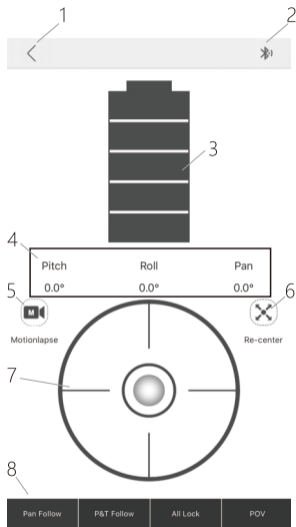

App "Hohem Gimbal" Instruction

Other App Functions

1. Gimbal Specs Setting:

- A. Following Speed (To adjust the following speed of pan/tilt/roll axis)
- B. Joystick Speed (To adjust the rotating speed by control the joystick)
- C. Following Dead Area (No following movement when the rotate angle is less than dead area setting)
- D. Trim (Adjust the tilt/roll axis in small angle)
- E. Joystick Reverse (Reverse the rotation direction by control the joystick)
- F. Motor Options (To adjust the motor torison of pan/tilt/roll axes, which is useful to solve the vibrate issue due to lightweight or overweight actioncam)
- G. Camera options: enable/disable charging output of gimbal mini USB port,
CAMERA CONTROL OPTIONS.

2. Firmware Upgrade: The firmware is subject to upgrade without a fixed schedule. Firmware upgrade is help to optimize the working of gimbal, please refer to page 13 for details.

3. Calibration: It requires to calibrate the gimbal only when you notice any kind of not level or drift on any of the axes, please refer to page 12 for details.

4. Operation Tutorial: For any questions, please refer to the user guide for details, the content is subject to change without prior notice.

Calibration

It requires to calibrate the gimbal if you notice it is not work properly as below.

1. The pitch angle is not level with the horizontal surface.
2. The roll angle is not parallel to the horizontal surface.
3. The pan axis drifts when the gimbal is on all lock mode.

Calibration Instruction

Method 1: Off-line Calibration

- (1) Power on the gimbal, long press the mode button over 6 seconds till the mode light on.
- (2) Laying the gimbal on a static flat surface without any vibrate. Calibration is completed once the mode light flash twice.

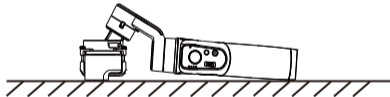

*If the off-line calibration is not useful, please refer to [Method 2]

Method 2: 6-Side Calibration Via App

Please make sure the gimbal is connected with app via bluetooth successfully, then enter "Calibration" and follow the instruction in the app to calibrate the gimbal.

Firmware Upgrade

Please make sure the gimbal is connected with app via bluetooth successfully, then enter the "Firmware Upgrade" and follow the instruction to upgrade the latest firmware.

FAQ

Q: Why the gimbal vibrates after powering on?

A: Make sure your actioncam is mounted firmly and well balanced before powering on the gimbal, do not turn on the gimbal without a balanced load, as doing so may damage the motors, please refer to page 6 for more details.

For some lightweight actioncam, it needs to adjust the motor torsion, please refer to page 10 for details.

Q: How to connect the gimbal via app?

A: Please be noted that the bluetooth and gimbal must be connected directly in the app "Hohem Gimbal", rather than connecting in the smartphone bluetooth list.

Make sure all the permission is allow and enable the GPS of your smartphone when you open the app for the first time.

Please refer to the tutorial video on our YouTube channel for more details.

Q: How to do if the gimbal is not level or drift after powering on?

A: Please refer to page 12 for details.

Parameters

Weight	365g include battery
Main Material	High performance composite
Payload	150g
Camera Size Supported	Max. Width: 48 mm Max. Thickness: 32 mm
Supported Actioncam	GoPro Hero 8/7/6/5/4/3, DJI OSMO Action, SONY RX0, YI, SJC AM, and other action camera with similar size and weight.
Splash Proof	IPX4 rating water splash proof, is resistant to water splashes from any direction.
Battery Capacity	3600 mAh
Working Time	12 hours
Charging Time	3.5 hours
Mechanical Range	Panning: 600°
	Rolling: 320°
	Tilting: 320°
Working Temperature	-10~45 °C
Motors Protection	Gimbal is able to power off automatically due to improper operation of the motors.
Standard Accessories	Tripod, Carry case, USB cable (for charging gimbal), Charging Cable(for charging actioncam)