



Terraced Double Raised Garden Bed

Installation Guide

Thank You!

You're only a few steps away from your perfect vegetable garden or elevated planter. We hope you enjoy!

Model# R0714D36
Dimensions 72" L x 36" W x 7" & 14" H

Before You Start

Please read the instructions carefully to familiarize yourself with every detail and step involved. Keep this manual for future reference. Find a suitable space to assemble your new Terraced Double Raised Garden Bed.

You need at least 72" x 36" (183 x 92cm) for the finished product. A flat and firm area (like a garage floor or flat yard space) is perfect! The only tool you may need is a rubber mallet.

Important Notes

Small parts are included; we advise you to keep them away from children and pets.

We also suggest having another person help you assemble. Maximum Load capacity: approximately 16 cu. ft. of soil

★ **Subscribe at www.everbloom-garden.com for extra savings and upgrading information!**



Everbloom-Garden.com

Questions or Comments?

Email us at service@everbloom-garden.com

Parts List

Terraced Double Raised Garden Bed - 72" L x 36" W x 7" & 14" H

Left Corner Post
(360mm) X 1

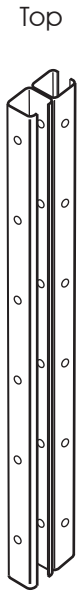

Bottom

Right Corner Post
(360mm) X 1

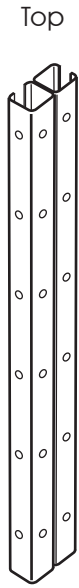

Bottom

Long Board
X 10

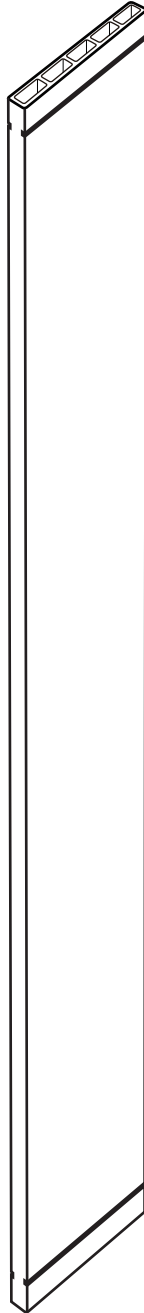

900mm

Left Joiner Corner
X 1

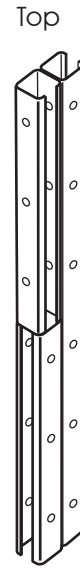

Bottom

Right Joiner Corner
X 1

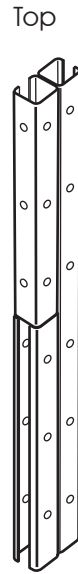

Bottom

Left Corner Post
(180mm) X 1

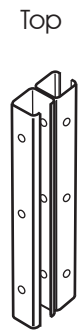

Bottom

Right Corner Post
(180mm) X 1

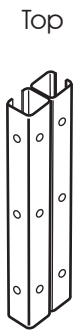

Bottom

Post Cap
X 6

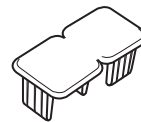

Assembly

Terraced Double Raised Garden Bed - 72" L x 36" W x 7" & 14" H

Start by making sure each corner post is oriented correctly. Reference Image 1. Fix the left joiner corner and left corner post (180mm) on one long board from above, as shown in Image 2.
Note: The boards need to be placed in the inward "U" shape of the brackets. (Image 2).

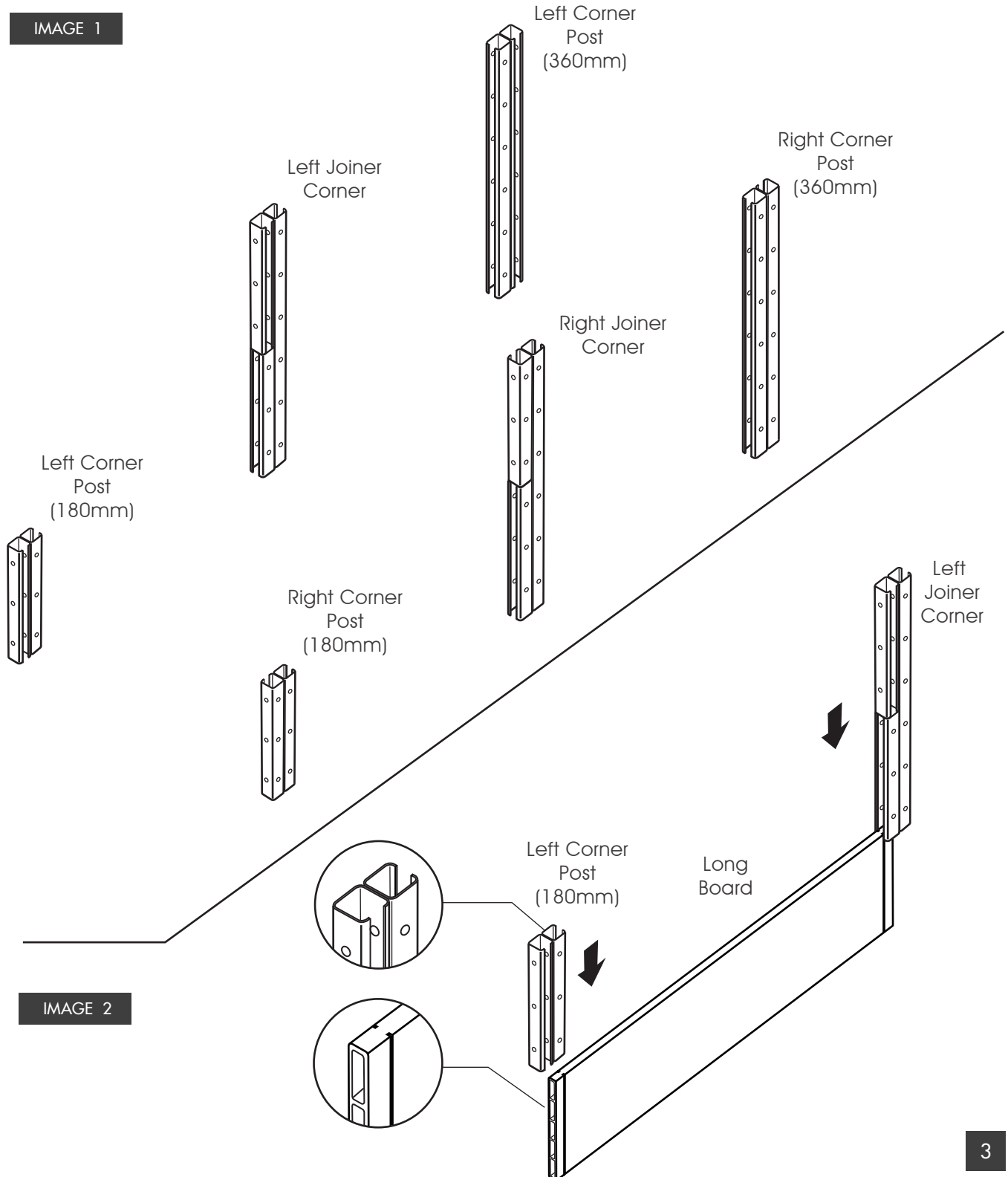

Assembly

Terraced Double Raised Garden Bed - 72" L x 36" W x 7" & 14" H

Fix the right joiner corner and right corner post on a long board from above, as shown in Image 3.

IMAGE 3

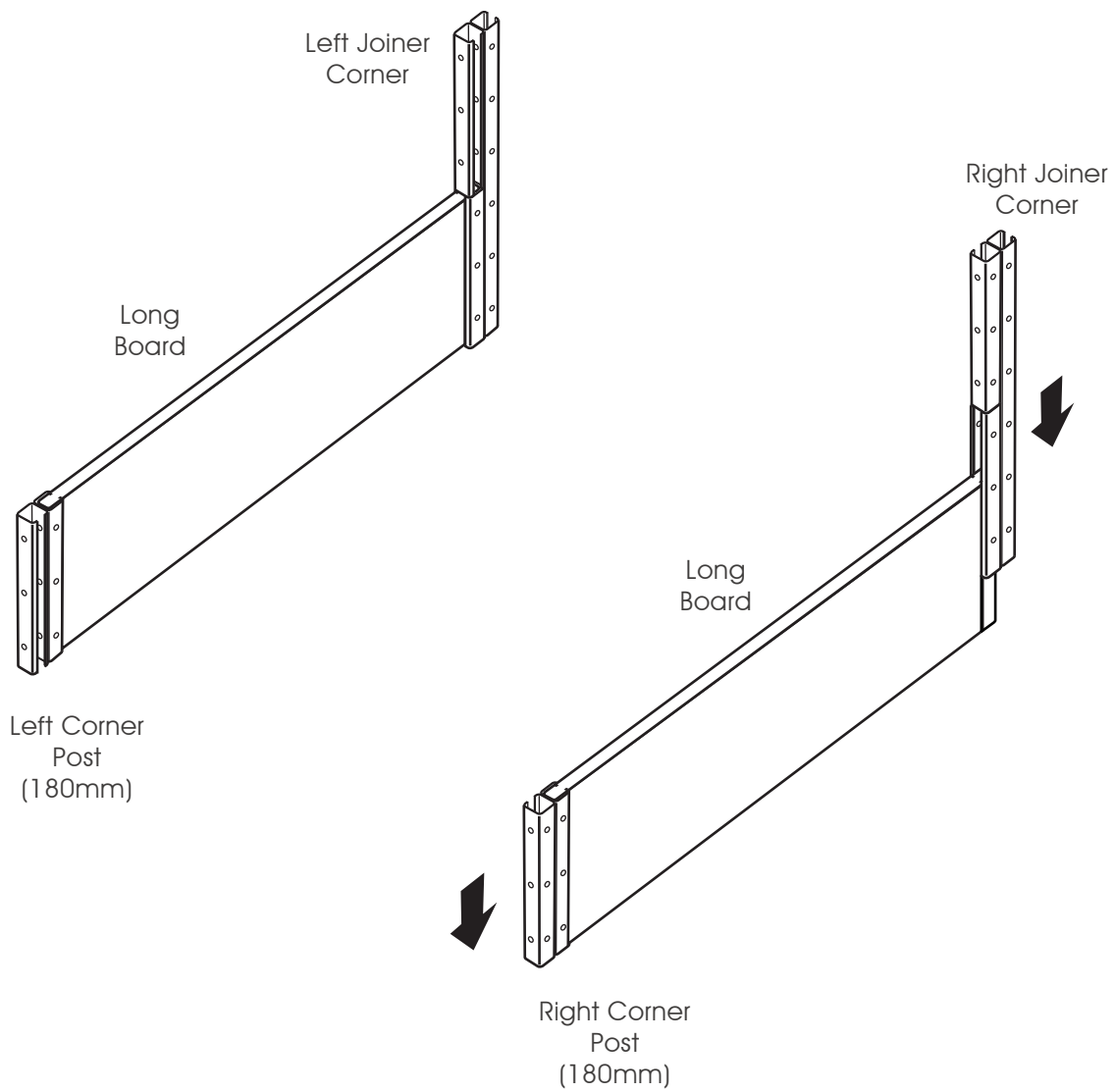

Assembly

Terraced Double Raised Garden Bed - 72" L x 36" W x 7" & 14" H

Slide the rest eight boards to form the bed, as shown in Image 4.

IMAGE 4

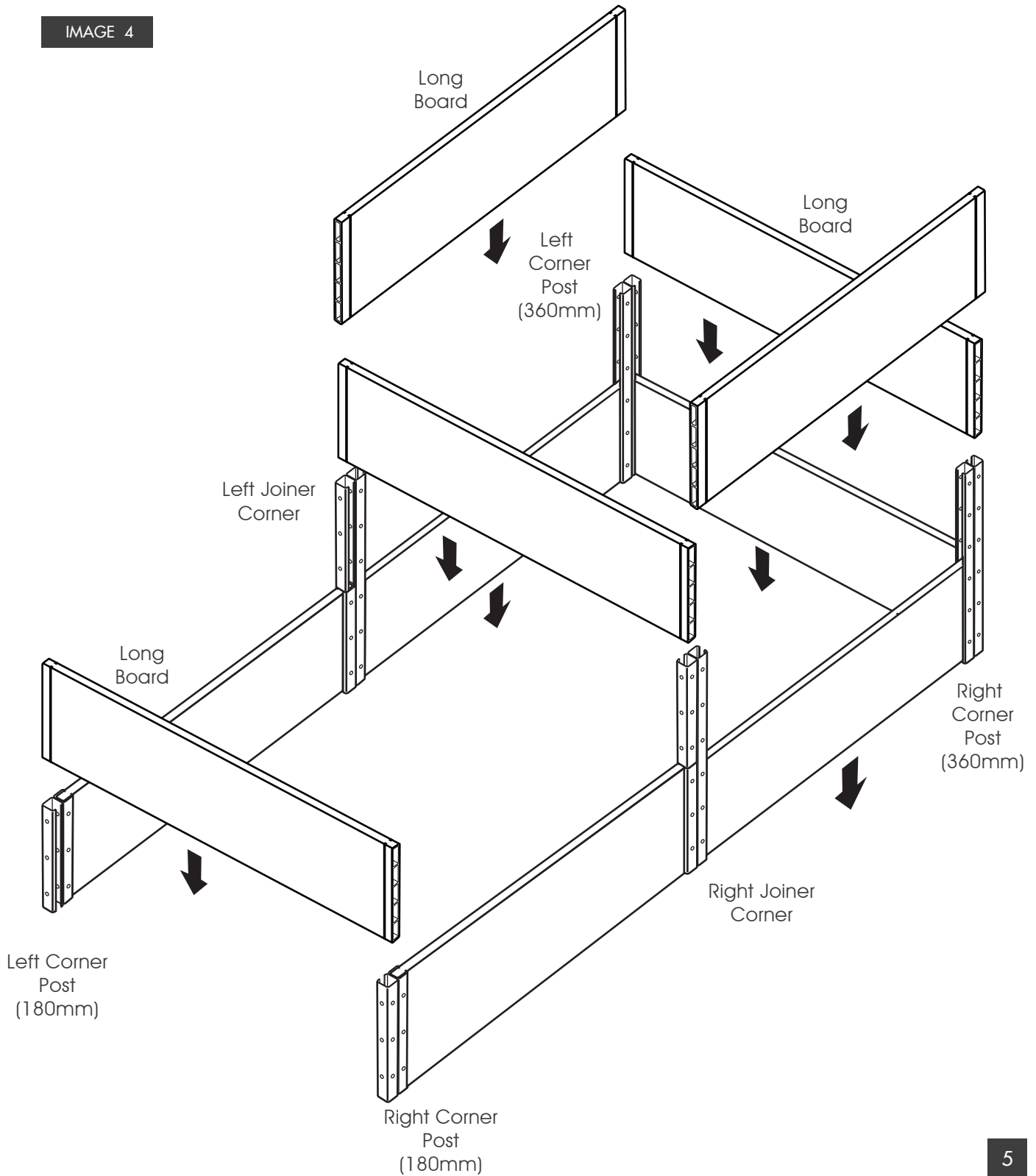

Assembly

Terraced Double Raised Garden Bed - 72" L x 36" W x 7" & 14" H

If necessary, use your rubber mallet to ensure the boards are tightly in place. Cover the brackets with the 6 end caps, as shown in Image 5.

IMAGE 5

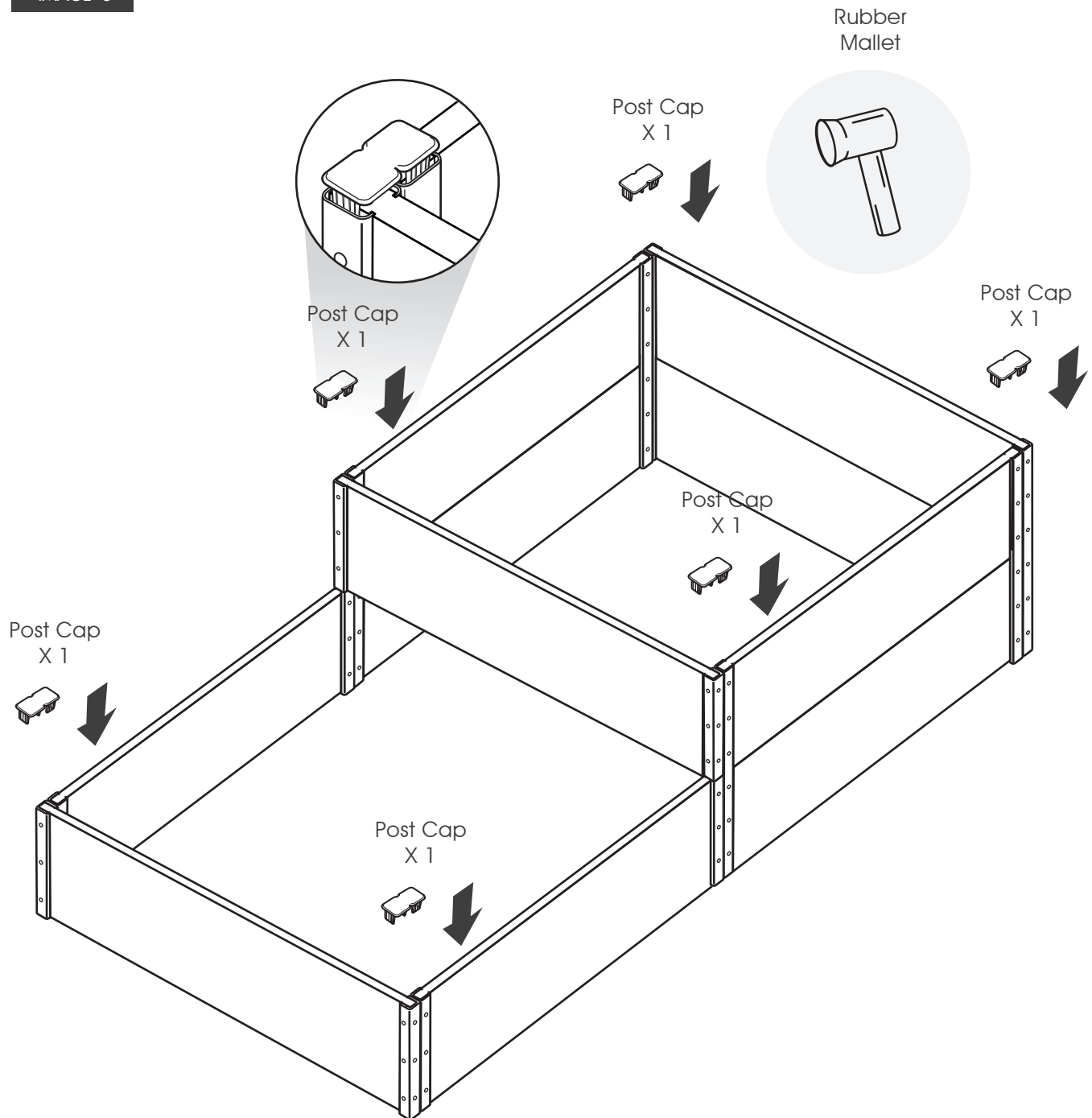

Note: Store the additional caps for future use.

Notes

Terraced Double Raised Garden Bed - 72" L x 36" W x 7" & 14" H

Sometimes there might be a misalignment of the Corner Posts as shown in Image 6 and Image 7, which may result in difficulty of sliding boards into the brackets. Please adjust them to the right position so that they are parallel to each other, and perpendicular to the ground.

IMAGE 6

Assembling Problem 1

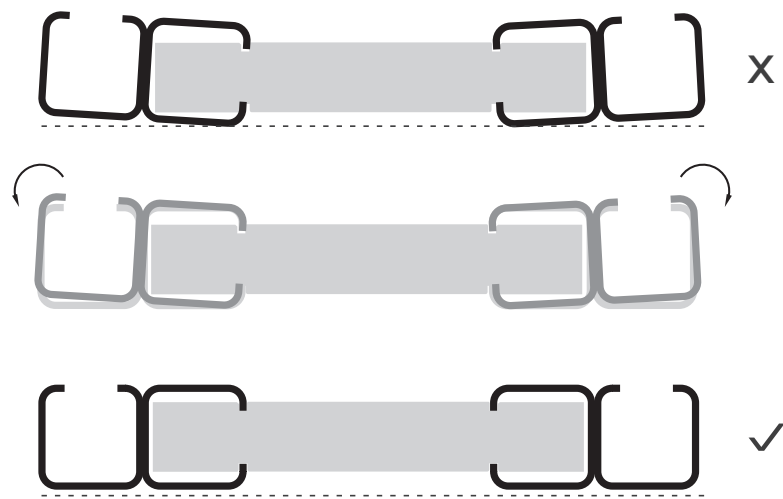
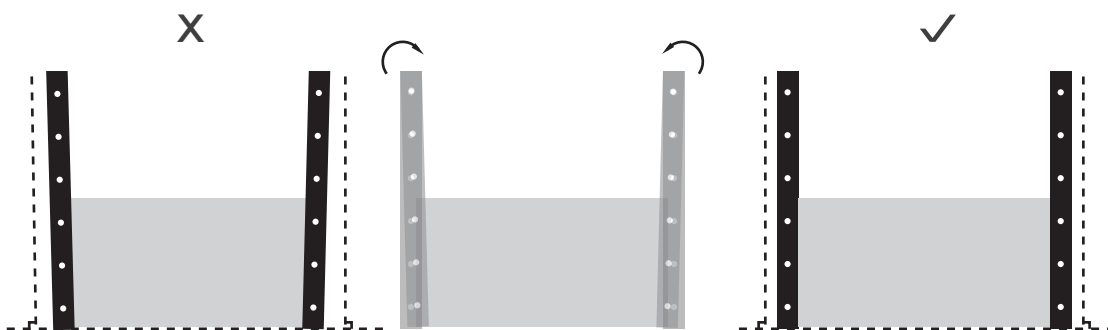

IMAGE 7

Assembling Problem 2



Bloom On.

Everbloom-Garden.com

US Patent Pending

★ Subscribe at www.everbloom-garden.com for
extra savings and upgrading information!

Distributed by:
Dynaforge Trading LLC
St. Paul, MN55101
Email: service@everbloom-garden.com