



Owner's Manual

R650 Ultra

Table of Contents

01	Important Safety Information
04	About Your Robot
10	Use Your Robot
21	Care and Maintenance
28	Troubleshooting
31	Specifications

Thank you for purchasing Coredy robot vacuum cleaner, please carefully read all instructions before using this robot, and keep this user manual properly for future reference.

Important Safety Information

This appliance can be used by children ages from 8 years and above and persons with reduced physical, sensory or mental capabilities or lack of experience and knowledge only if they have been given supervision or instruction concerning use of the appliance in a safe way and understand the hazards involved. Children shall not play with the appliance. Cleaning and user maintenance shall not be made by children without supervision. Children younger than 8 years old should not use this device.

The robot must be used in accordance with the directions in this Instruction Manual. CoreDy Inc. cannot be held liable or responsible for any damages or injuries caused by improper use.

To reduce the risk of injury or damage, keep these safety precautions in mind when setting up, using and maintaining your robot:

- Read all safety and operating instructions before operating your robot.
- Retain the safety and operating instructions for future reference.
- Heed all warnings on your robot, battery, charging Dock and in the owner's manual.
- Follow all operating and use instructions.



The symbol on the product or its packaging indicates:

Do not dispose of electrical appliances as unsorted municipal waste, use separate collection facilities. Contact your local authority for information regarding the collection systems available. If electrical appliances are disposed of in landfills or dumps, hazardous substances can leak into the groundwater and get into the food chain, damaging your health and well-being. Please contact your local or regional waste authority for more information on collection, reuse and recycling programs.

Usage Restrictions

- Your robot is for indoor use only. Do not use the robot in outdoor, commercial or industrial environments.
- Before using this device, pick up objects like clothing, loose papers, pull cords for blinds or curtains, power cords, and any fragile objects. If the device passes over a power cord and drags it, there is a chance an object could be pulled off of a table or shelf.

- Your robot is not a toy. Do not sit or stand on this device. Small children and pets should be supervised when your robot is operating.
- Store and operate your robot in room temperature environments only.
- Do not use this device to pick up anything that is burning or smoking.
- Do not use this device to pick up spills of bleach, paint, or other chemicals, or anything wet.
- If the room to be cleaned contains a balcony, a physical barrier should be used to prevent access to the balcony and ensure safe operation.
- This appliance is not intended for use by persons (including children) with reduced physical, sensory or mental capabilities, or lack of experience and knowledge, unless they have been given supervision or instruction concerning use of the appliance by a person responsible for their safety.
- Children should be supervised to ensure they do not play with the robot. Cleaning and maintenance shall not be performed by children without supervision.
- Do not place anything on top of your robot.
- Be aware that the robot moves on its own. Take care when walking in the area in which the robot is operating in to avoid stepping or tripping on it.
- Do not operate the robot in areas with exposed electrical outlets in the floor.

Battery and Charging

- Use only rechargeable battery packs with the correct specification approved by Coredy.
- Charge using a standard outlet only. Product may not be used with any type of power converter. Use of other power converters will immediately void the warranty.
- Do not use a Charging Dock with a damaged cord or plug. If the cord or plug is damaged, it must be serviced by the manufacturer or similarly qualified persons.
- Always charge and remove the battery from your robot and accessories before long-term storage or transportation.
- Charge indoors only.

- Your robot's Charging Dock may be protected with a surge protector in the event of severe electrical storms.
- Never handle the Charging Dock with wet hands.
- Always disconnect your robot from the Charging Dock before cleaning or maintaining it.
- Please ensure voltage rating for enclosed Charging Dock matches standard outlet voltage.
- Used battery packs should be placed in a sealed plastic bag and disposed of safely according to local environmental regulations.
- Before every use, check the battery pack for any sign of damage or leakage. Do not charge damaged or leaking battery packs.
- If the battery pack is leaking, contact Coredy Customer Service for disposal.
- The battery pack must be removed from the robot before disposal.
- Do not crush or dismantle battery packs. Do not heat or place the battery pack near any heat source.
- Do not incinerate the battery pack. Do not short-circuit the battery pack.
- Do not immerse the battery pack in any liquid.





FCC Statement

This device complies with Part 15 of the FCC Rules. Operation is subject to the following two conditions: (1) this device may not cause harmful interference, and (2) this device must accept any interference received, including interference that may cause undesired operation.

About Your Robot

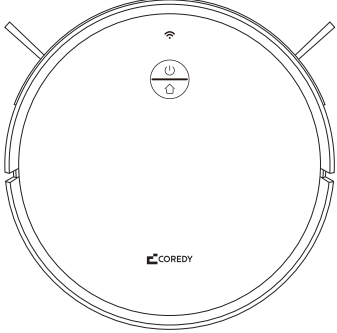
Robot

a. Top & Side

		Press and hold for 3 seconds to turn on or off Press to start Auto Cleaning Press to pause current cleaning task
		Press to return the robot to the charging dock Press again to pause
		Press and hold both buttons for 5 seconds to reset Wi-Fi connection

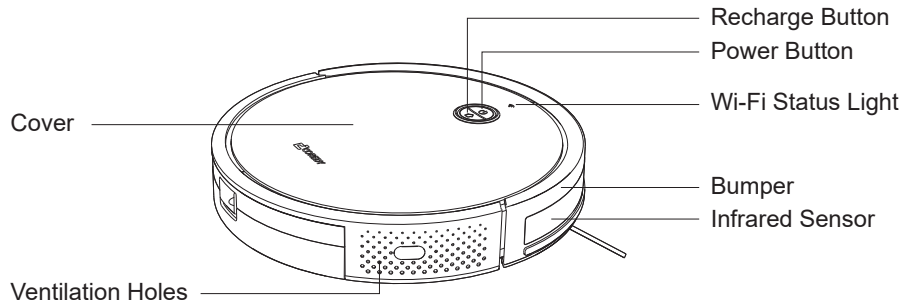

b. Bottom

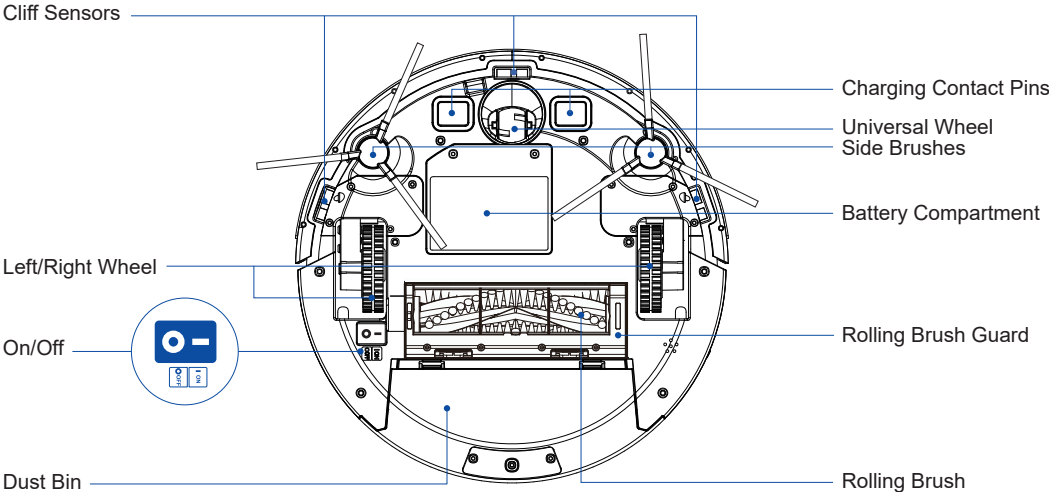

c. Dustbin

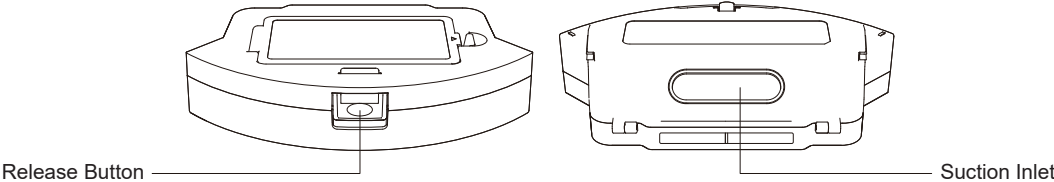

d. Charging Dock

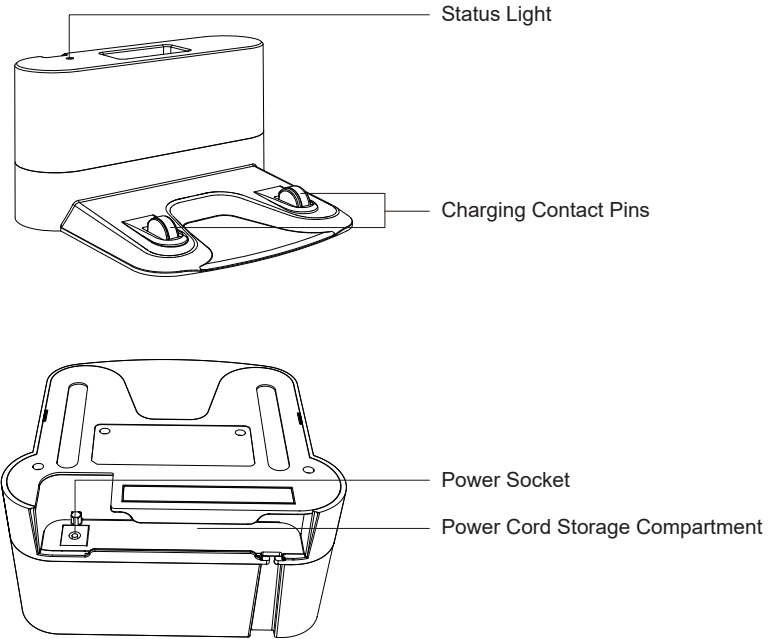

e. Remote Control

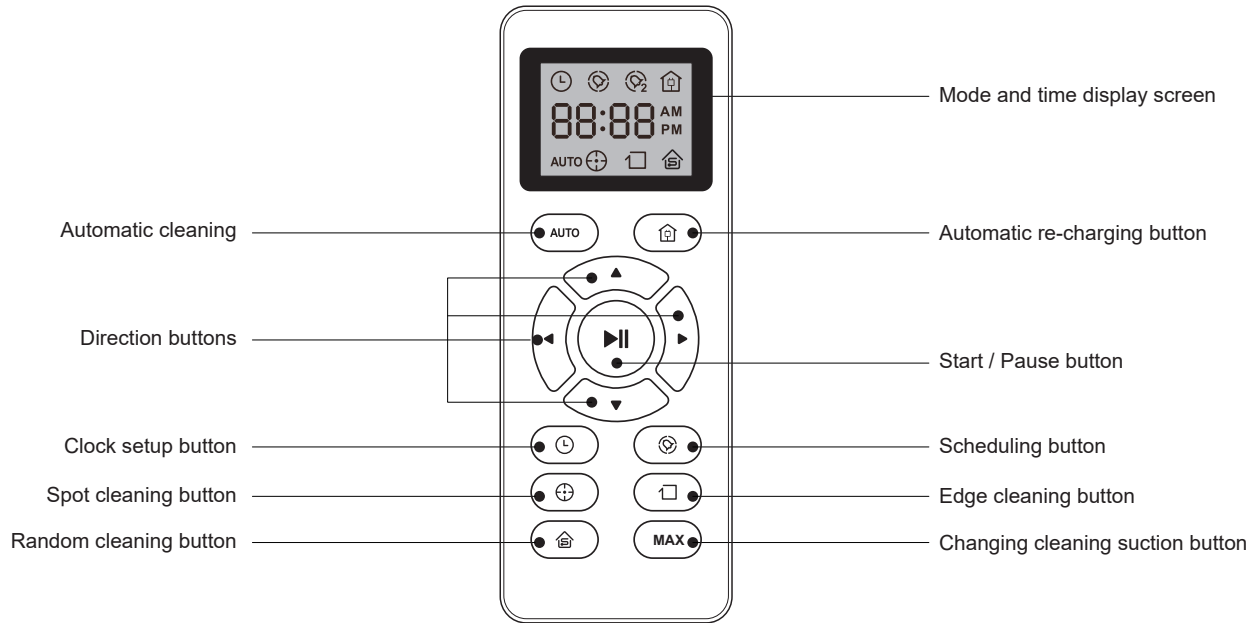

Install 2 AAA batteries (included in the package) before using the remote control.

Accessories

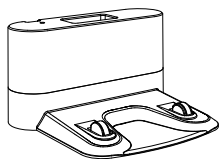

Charging Dock

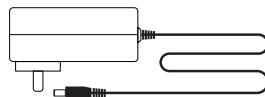

Adapter



Remote Control

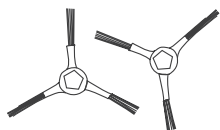

Side Brush

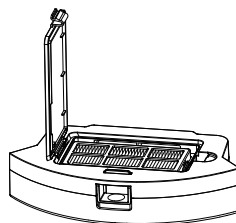

Dustbin





Rolling Brush



Cleaning Tool

Indication

 Light Status	Status
Solid Blue	Turn On/ Standby/ Cleaning/ Pause/Return to Charge
Breathing Blue	Charging
Red	Error
Off	Turn Off/ Sleep

 Wi-Fi Status Light	Status
Rapidly Flashing Blue	Waiting for connection
Slowly Flashing Blue	Wi-Fi Pairing
Solid Blue	Wi-Fi connected

Use Your Robot

Notes Before Cleaning

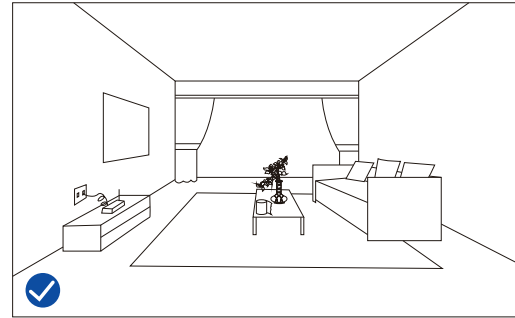
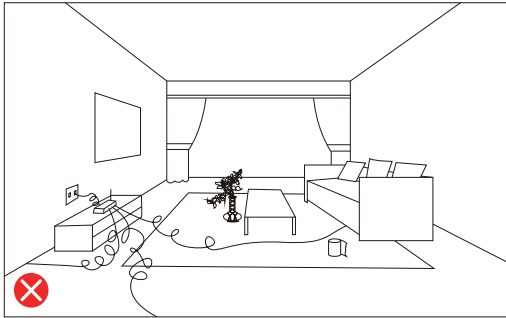

Before using Robot, pick up objects like clothing, loose papers, pull cords for blinds or curtains, power cords, and any fragile objects. If the Robot passes over a power cord and drags it, there is a chance an object could be pulled off of a table or shelf.

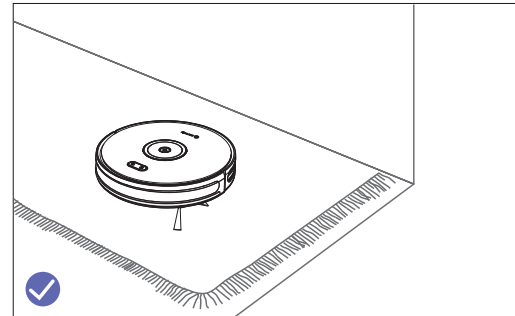
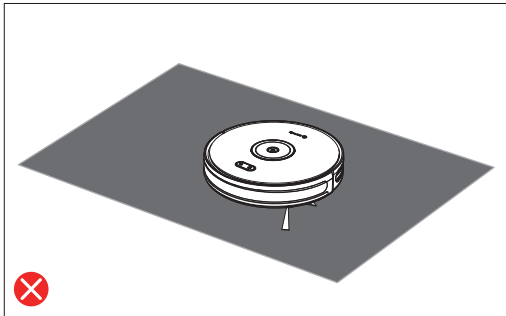

The robot may not run on certain dark or black colored surfaces since the Anti-drop Sensors that recognize an edge or a stair may regard this color as an edge.

Prepare Your Robot

1. Remove the protective form before use.
2. Install the side brushes.
3. Turn on the main power switch on the bottom of the robot.

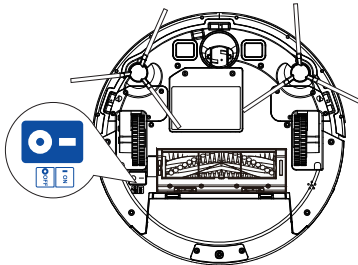
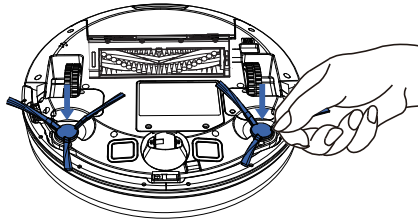
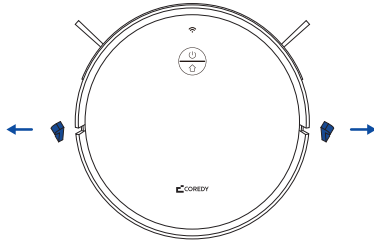

Place Charging Dock

1. Place the charging dock on a hard, level surface and against a wall.
2. Ensure the charging dock is in an open and uncluttered area leaving at least:
 - 6ft/2m in the front of the charging dock.
 - 3ft/1m on both sides of the charging dock.
3. Connect the charging dock to the power outlet.
 - When the charging dock connects to AC power, the LED indicator on the charging dock is Solid White.



- Wrap out the extra power cord.
- Always keep the charging dock plugged in, otherwise robot will not automatically return to it.

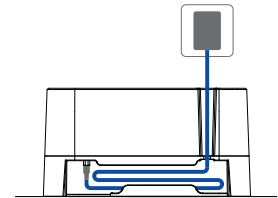
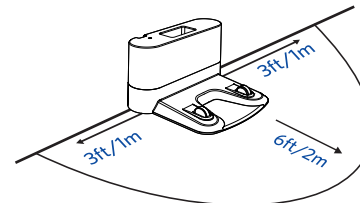
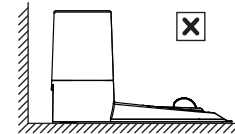
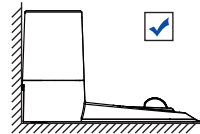

Charge Your Robot

Place your robot on the charging dock by aligning its charging pins with the charging pins on the dock.



Robot cannot start cleaning if the battery power is low, so please make sure the robot is fully charged before first use.

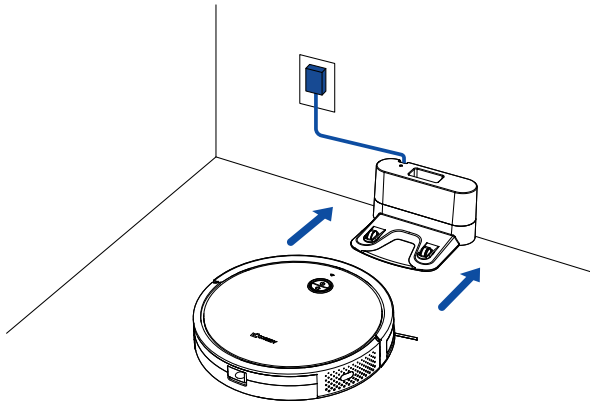

Start/Stop Cleaning



Make sure the main power switch on the bottom of robot is turned on before use.

- Press  on robot or  /  on the remote control to start a cleaning cycle in Auto Mode.

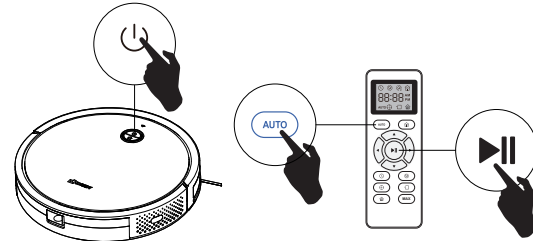

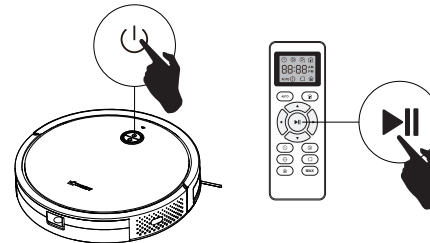

- Press  on robot or  on the remote control to stop cleaning.



- You can also start or stop cleaning via Coredy Robot app.

Reset Wi-Fi Connection

Press and hold  +  on the Robot for around 5 seconds until you hear two beeps from the robot and the indicator lights on Robot is rapidly flashing blue.

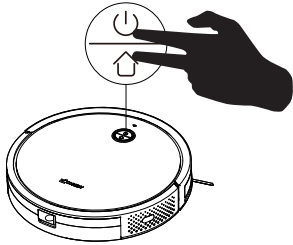

Connect with Coredey App

Open the app and create a user account, and then follow the instructions to add your R650 Ultra robot. (Refers to “App Installation Guide” for detailed guidance.)

Select a Cleaning Mode

Auto Cleaning

Coredey R650 Ultra moves from the Charging Dock and automatically determines its cleaning route, following a row-by-row cleaning path. When the cleaning cycle is finished, it automatically returns to the Charging Dock.

- If the battery reaches low charge before finishing a cleaning cycle, the robot will return to the Charging Dock to recharge.
- If the Charging Dock is inaccessible, robot will not be able to recharge, please place the robot manually on Charging Dock for charging.

Press  on robot or  /  on the remote control to start cleaning in Auto Cleaning mode.

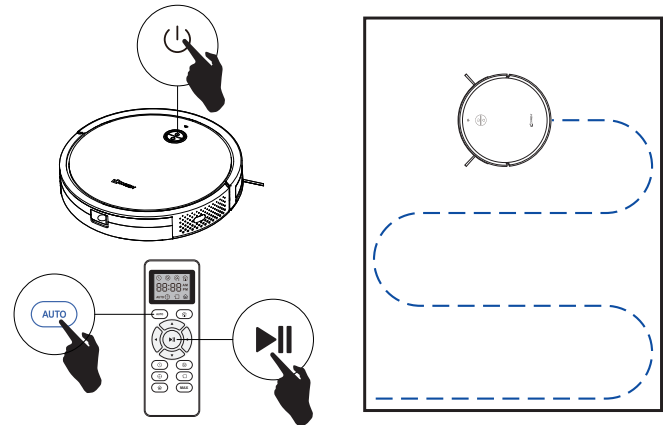

Select a Suction Power Level

Press **(MAX)** on the Remote Control to switch suction power level, or select a suction power level in the Coredy Robot app according to your needs:

- Small
- Standard (Default)
- Strong

Boost-Intellect Feature

R650 Ultra supports Boost Intellect technology, when a carpet is detected, suction is increased to 1600Pa suction power from current suction power level. Once off the carpet, normal suction returns.

If the level of the suction power is the maximum level before cleaning on a carpet, the robot will continue cleaning the carpet with the maximum power after moving on the carpet.

Spot Cleaning

When you select Spot Cleaning, robot intensely cleans a localized area by spiraling outward about 3 feet (1 meter) in diameter and then spiraling inward to where it started. When Spot Cleaning, robot boosts its vacuum power to provide the best cleaning possible where you need it.

To use Spot Cleaning, place robot on top of the localized debris and press **(⊕)** on the Remote Control, or select Spot Cleaning mode in the Coredy Robot app.

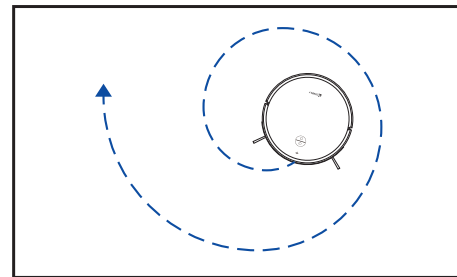
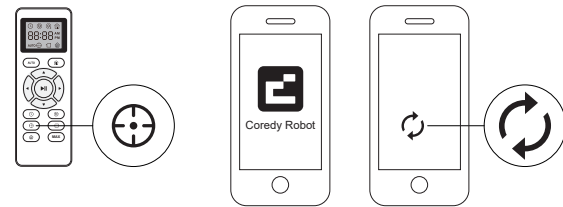

Edge Cleaning

After robot finishes cleaning the open areas of your floor, it uses Edge Clean to ensure that it has cleaned along walls and around furniture legs for a thorough clean.

If you prefer a quicker edge cleaning, press  on Remote Control or select Edge Cleaning mode in the Coredy Robot app.

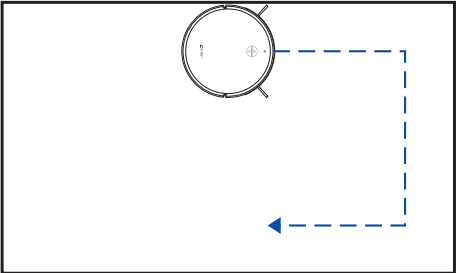
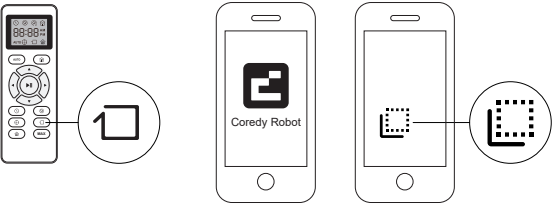

Manual Cleaning

You can direct R650 Ultra to clean a particular area by using the directional buttons on the remote control or control in the Coredy Robot app.

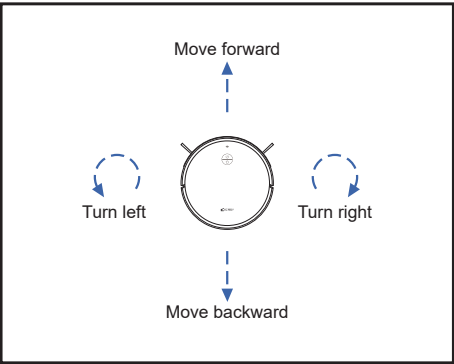
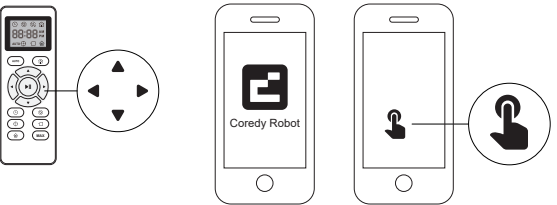

Random Cleaning

Press  on Remote Control or select Random Cleaning mode in the Coredy Robot app.

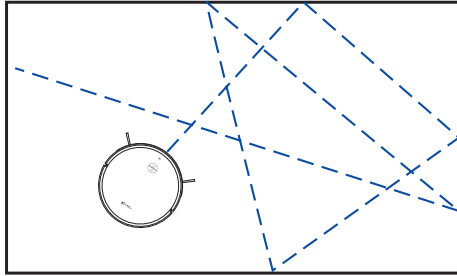
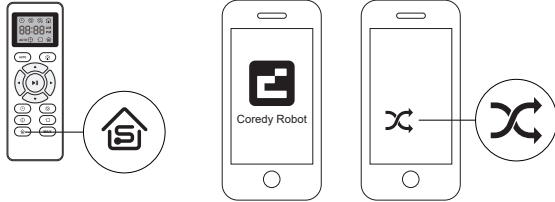

Use the Boundary Strip

 **Boundary strip is sold separately.**

With the Boundary Strip, you can keep R650 Ultra away from any area or item you do not want R650 Ultra to clean. R650 Ultra will recognize the Boundary Strip and will not cross into the blocked-off area.

1. Identify the area or item you do not want R650 Ultra to get close to.
2. If necessary, use scissors to cut the Boundary Strip to a shorter length. Be sure to correctly measure the length before cutting.
3. Apply adhesive tape to lay the Boundary Strip flat on the floor.



- Make sure the strip is placed **FLAT** on the floor.
- If the Boundary Strip is rolled up, remove and re-apply on the floor with adhesive tape. Otherwise, the Boundary Strip may not work well.
- Make sure the Boundary Strip is placed on the same surface plane R650 Ultra is used on.
- Be careful not to damage the floor when using adhesive tape. It is not recommended for use on carpets.
- Keep the Boundary Strip away from objects that emit excessive heat.

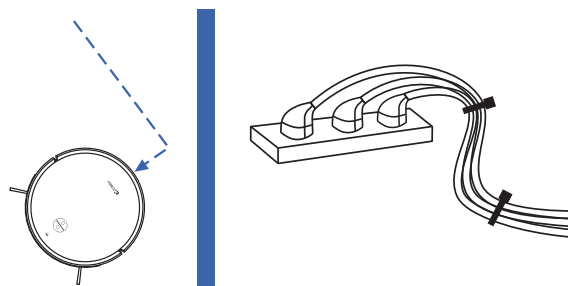
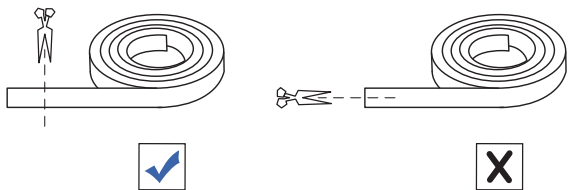

Wet-Dry Mop Cleaning



Water tank and mopping cloth are sold separately.

Coredy R650 Ultra has a mopping system with an electronically-controlled water pump, can automatically control water flow to start/stop, offers 3 water flow levels, ensuring intelligent mopping cleaning for your home.



- Mop Cleaning cleans best on smooth hard surfaces and may not perform so well on uneven tiles, heavily waxed floors or rough surfaces
- Do not use the mopping mode on a carpeted floor. It is recommended to place boundary strips to avoid cleaning the carpeted area.
- The mopping mode is not recommended when no one is at home.

1. Attach the mopping cloth to the Water Tank and fill the Water Tank with water.

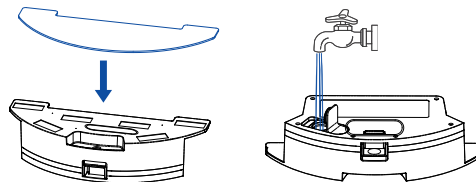

2. Remove the Dustbin from the robot.

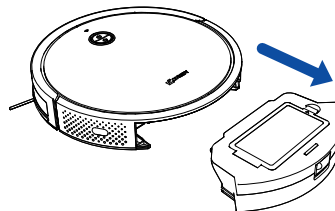

3. Install the Water Tank into the robot.

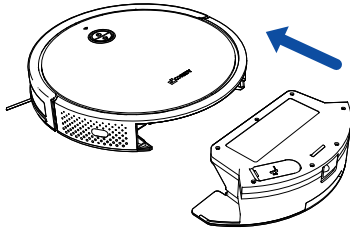

5. When robot finishes working and returns to the Charging Dock, press the release button to remove the Water Tank.

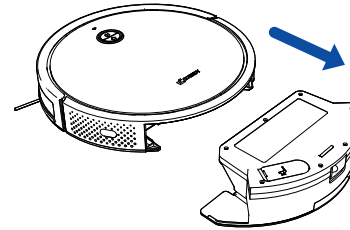

4. Select a mopping level to start mopping.
Use the Coredy Robot App to select from 3 water flow levels for mopping cleaning on the different surface floor.

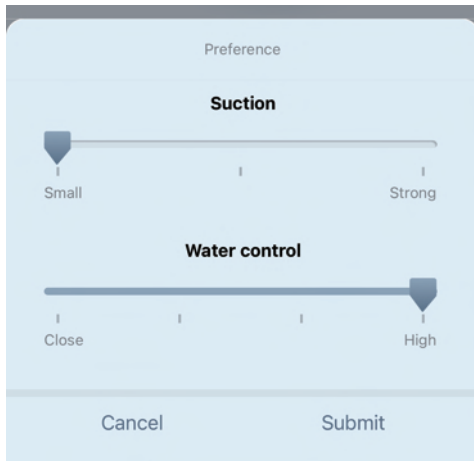

6. Put the Dustbin back into the robot.



After mopping, remove the water tank, empty any remaining water and clean the mopping cloth to prevent mildew or unpleasant smells.

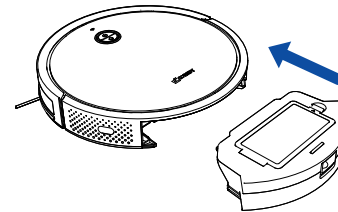

Set a Scheduled Cleaning

Schedule your robot to start cleaning at a particular time with Remote Control or Corey Robot app.

Coredy R650 Ultra has cleaning schedule settings which allow you to customize when the robot cleans your home.

1. Schedule Cleaning from Corey Robot App

With the Corey Robot App, you can schedule the R650 Ultra to start cleaning at any desired time from Sunday to Saturday (or certain days of the week).



1. You can set the time and customize the cleaning schedules from Sunday to Saturday on the Corey Robot App.
2. Schedule accuracy is +/- 30 seconds.
3. This function is available in the App only.

2. Schedule Cleaning from Remote Control

With the remote control, you can schedule R650 Ultra to start cleaning at a specified time.





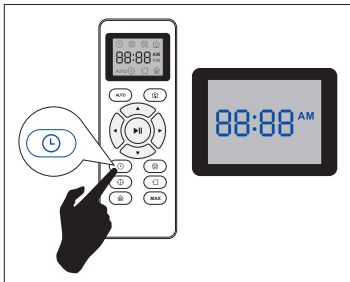

1. Make sure the time is set correctly to your local time before setting a cleaning schedule.
2. Make sure AM/PM is set correctly.
3. Schedule accuracy is every 15 minutes.
4. Make sure the remote control is near the robot while setting the clock or schedule.

Set the Remote Control's Clock

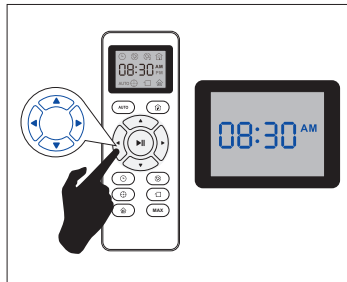

Press  button on Remote Control, and then the hour section begins to flash in the clock display setting window.



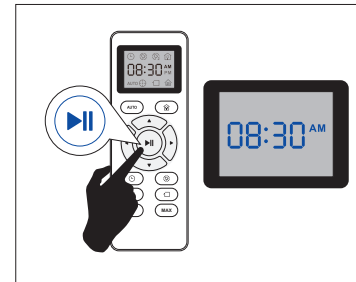

Press  or  button to select the desired figures. Press the  or  button to select the minute or hour section.





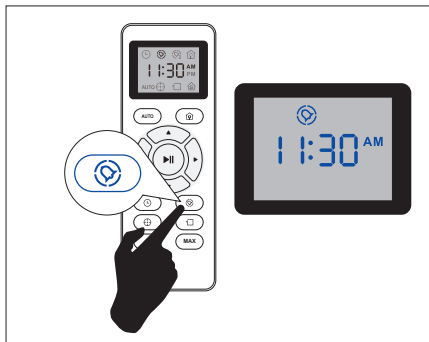

And then press the  button, the Robot will "BEEP" when the clock setting completed.

Setting Cleaning Schedule

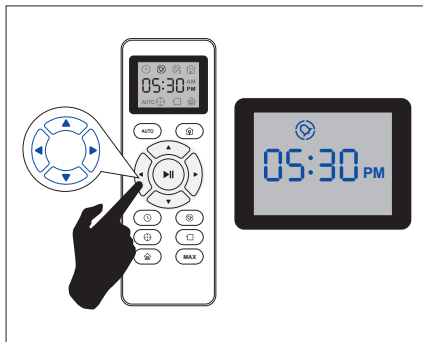

Press  button on Remote Control, and then the hour section begins to flash in the Cleaning Schedule display setting window.



Press  or  button to select the desired values. Press the  or  button to select the minute or hour section.



And then press the  button, the Robot will “BEEP” when the Cleaning Schedule setting completed.

Cancel the Cleaning Schedule

Press and hold  button approximately 4 seconds on Remote Control, the Robot will “BEEP” when the Cleaning Schedule process has cancelled completely.

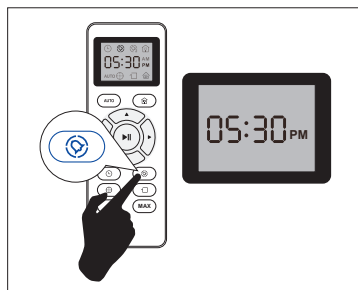

Care and Maintenance

To keep the robot running at peak performance, follow the care instructions below to clean and maintain your robot regularly. The cleaning/replacement frequency will depend on the usage habits of the robot and the home environment.

Recommend care/replacement frequency:

Robot Part	Care Frequency	Replacement Frequency
Side Brush	Once every week (twice every week in homes with pets)	Every 2~3 months (or when visibly worn)
Filter	Once every week (twice every week in homes with pets)	Every 2~3 months
Rolling Brush	Once every week (twice every week in homes with pets)	Every 3~6 months
Dustbin	After each use	Every 12 months
Water Tank	After each use	Every 12 months
Mopping Cloth	After each use	Every 3~6 months (or when visibly worn)
Cliff Sensors Charging Contact Pins Caster Wheel Driving Wheels	Once each week	—



If you need replacement parts/accessories, please contact Coredy Customer Care for more information.

Dustbin and Filter

1. Press the release button to pull the dustbin out.
2. Open and empty the dustbin.
3. Open the filter cover and take out the filter compartment.
4. Remove filter net and take out the filter.
5. Shake off debris by tapping the filter against your trash container.



Be sure to thoroughly air-dry all the parts before reassembling.

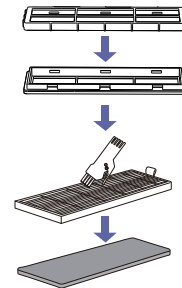
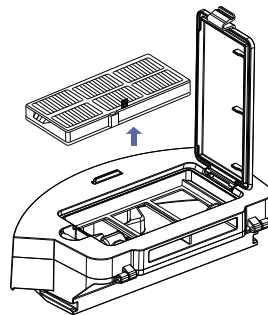
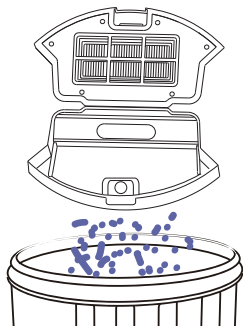
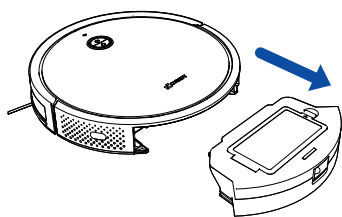

Water Tank



Water tank and mopping cloth are sold separately.

1. Press the release button to pull the water tank out.
2. Remove the mopping cloth from water tank, wash and lay flat to dry.
3. Empty the remaining water from the water tank.
4. Use soft and dry cloth to wipe the outside of water tank, lay flat to dry.



It is recommended to clean the washable mopping cloth and water tank after each use and air-dry completely to prevent mildew or unpleasant smells.

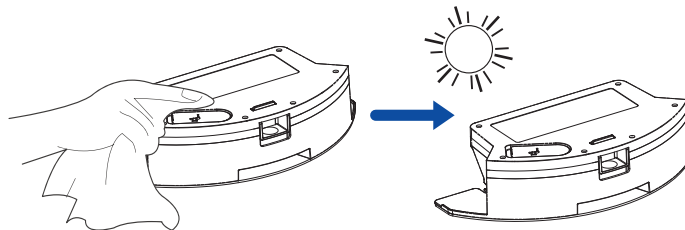
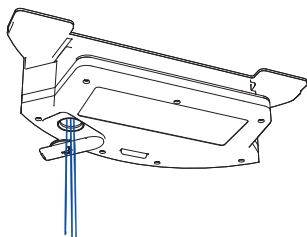
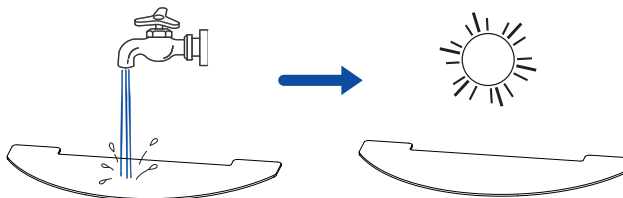
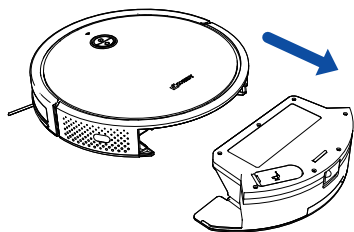

Side Brush

- 1.Remove the side brushes.
- 2.Clean and remove foreign substances such as hair, string wrapped between the robot and the side brushes.
- 3.Reinstall the side brushes.

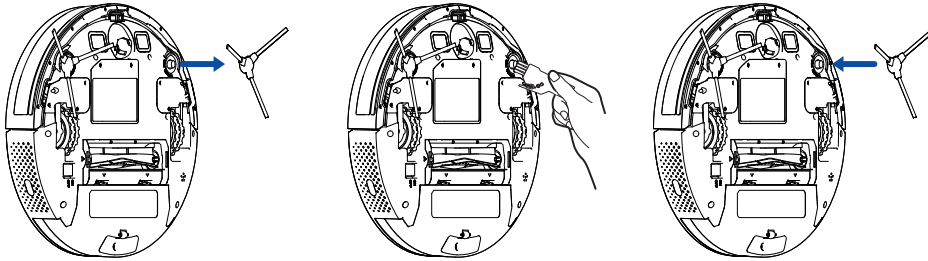

Rolling Brush

- 1.Pinch the brush frame release tab, lift the tab, and remove the brush guard.
- 2.Remove the rolling brush from the robot.
- 3.Remove the brush cap from the end of the brush. Remove any hair or debris that has collected beneath the cap, reinstall the brush cap.
- 4.Clean the rolling brush, remove any hair or debris.
- 5.Reinstall the rolling brush by inserting fixed protruding end first and then clicking into place.
- 6.Press down to snap the brush guard into place.

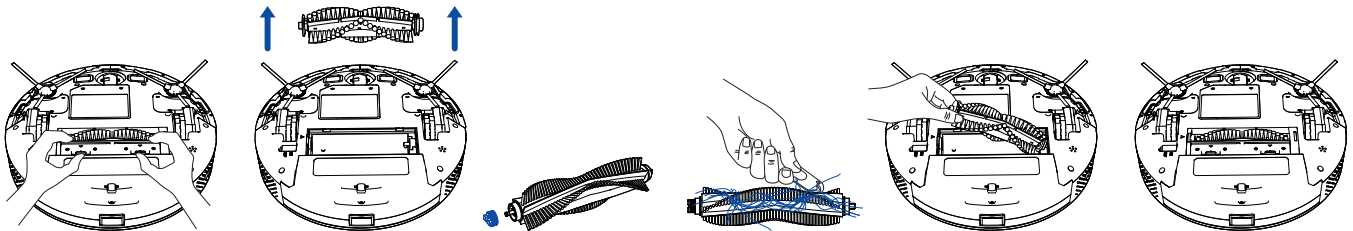

Sensor and Charging Contact Pins

Clean the sensors and charging contacts regularly using a soft cloth.

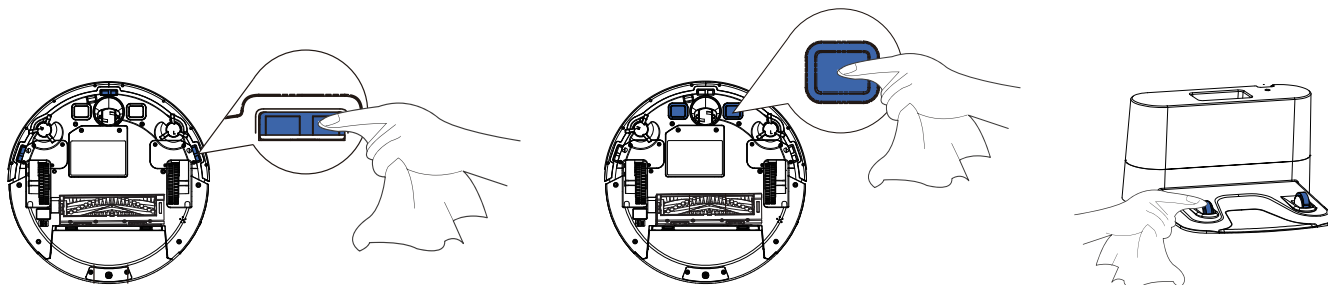

Battery and Charging Information

Lithium-Ion Battery

Important: Lithium-Ion batteries and products that contain lithium-Ion batteries are subject to stringent transportation regulations. If you need to ship this product (with the battery included) for service, travel or any other reason, you **MUST** comply with the following shipping instructions:

- Remove the lithium-Ion battery from the product
- Place a piece of tape over the battery's metal charging contacts
- Reinstall the battery (with the tape on it) in the product and secure the battery door
- Package the product in its original packaging or in your own packaging that prevents any movement during transportation
- Ship via ground transportation only (no air shipping)

Battery Charging

To extend battery life, always keep robot charged on the Home Base when not in use.

Battery Storage

If storing robot off the Charging Dock, remove the battery first. Then store robot and the battery in a cool, dry place.

Battery Disposal

Contact your local waste management authority for battery recycling and disposal regulations in your area.

Battery Replacement

You can visit Coredy's website <http://shop.coredy.com> to purchase the battery or other accessories for the robot.

Battery Removal

Follow these instructions to remove and reinstall robot's battery:

1. Unscrew the door and the two screws on the battery door, then remove.

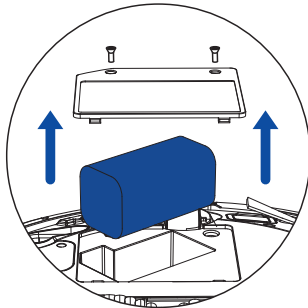
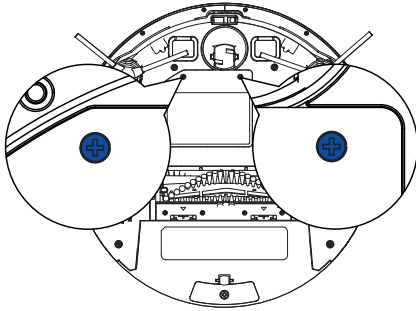

2. Reinstall the battery with the battery label and tabs facing up.

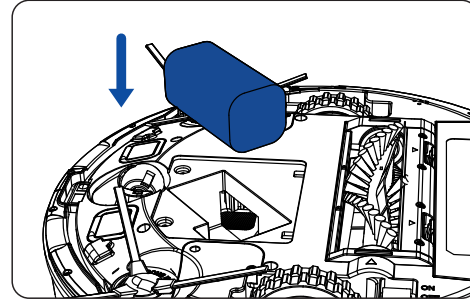

3. Reinstall the battery door and the two screws. Take care not to pinch the side brush in the battery door when re-installing the battery.

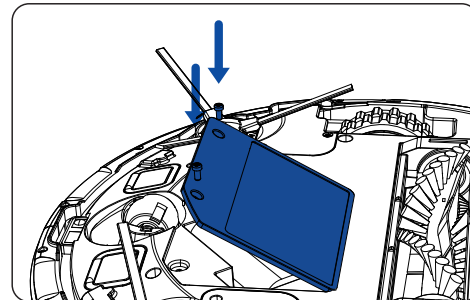

Troubleshooting

Refer to the chart as below to resolve Robot's problem. If the problem is not resolved, please contact our COST FREE customer service team for more assistance.

Rebooting Instructions

For some errors, rebooting Robot may resolve the problem. To reboot Robot, press the power switch on the bottom on Robot, you will hear an audible tone signifying a successful reboot.

Solid Red Indicator Light

Sound	Cause	What to Do
One Beep	Left/Right wheel may be stuck or trapped.	<ul style="list-style-type: none">● Clear any obstacles in the surrounding area and check the wheel for any trapped dust. Move the device to a new position and try again.
Two Beeps	Side brush may be stuck.	<ul style="list-style-type: none">● Clean the side brush then restart the robot.
Three Beeps	Suction fan is stuck or its filter is clogged.	<ul style="list-style-type: none">● Make sure the vacuum inlet is not blocked by any hair or debris.● Remove and empty robot's dust bin, clean robot's filter, then briskly tap the bin to loosen any remaining trapped debris.● If the issue persists, contact customer support for help.
Four Beeps	Rolling brush may be stuck.	<ul style="list-style-type: none">● Remove and clean the main rolling brush and brush guard, then press the power button to restart the robot.

Flashing Red Indicator Light



Sound	Cause	What to Do
One Beep	<ul style="list-style-type: none">● Dustbin is not installed.	<ul style="list-style-type: none">● Check if dustbin
Two Beeps	<ul style="list-style-type: none">● Bumper may be stuck.	<ul style="list-style-type: none">● Clean the side brush then restart the robot.
Three Beeps	<ul style="list-style-type: none">● Robot's cliff sensors are dirty.● Device may be suspended in air.● Robot is hanging over a drop, or it is stuck on a dark surface.	<ul style="list-style-type: none">● Clean robot's cliff sensors gently with a dry cloth.● Start cleaning in a new location if robot is hanging over a drop, or on a dark surface.● Use boundary strip or a physical barrier to block off the problem area.
Four Beeps	<ul style="list-style-type: none">● Robot's battery power level is too low.● Robot cannot return to its charging dock.	<ul style="list-style-type: none">● Manually take the robot on the charging dock to charge.● Ensure there are no obstacles in front of the charging dock or starting position, wipe the charging contacts on both charging dock and robot with a clean, dry cloth.



Frequently Asked Questions

Problems	Solutions
Coredy R650 Ultra cannot be activated.	<ul style="list-style-type: none"> • Make sure the main power switch is in the ON position. • Make sure the battery is fully charged. • Replace the batteries (2 AAA) in the remote control. • Make sure the remote control is within range (16 ft/5 m) of Coredy R650 Ultra. • If you still have trouble, turn off the main power switch and then turn it back on.
The remote control does not work.	<ul style="list-style-type: none"> • Replace the batteries in the remote control. • Make sure Coredy R650 Ultra is turned on and fully charged. <p>Note: Limited workable range distance is 5m/16.5ft.</p>
Coredy R650 Ultra stops working suddenly.	<ul style="list-style-type: none"> • Check if Coredy R650 Ultra is trapped or stuck on an obstacle. • Check if the battery level is too low. • If you still have trouble, turn off the main power switch, wait for 2 seconds, and then turn it back on.
You cannot schedule cleanings.	<ul style="list-style-type: none"> • Make sure the main power switch on the bottom of Coredy R650 Ultra is turned on. • Make sure the time, time of day (AM/PM), and the scheduled time have been set correctly. • Check if Coredy R650 Ultra's power is too low to start cleaning.
Suction power is weak.	<ul style="list-style-type: none"> • Check if any obstructions are blocking the suction inlet. • Empty the dust collector. • Clean the filters with a vacuum cleaner or a cleaning brush. • Check if the filters are wet due to water or other liquid on the floor. Air-dry the filters completely before use.
Coredy R650 Ultra cannot be charged.	<ul style="list-style-type: none"> • Check if the indicator on the Charging Base lights up. If not, contact the Coredy service center to repair or replace the Charging Base. • Dust off the charging contact pins with a dry cloth. • Check if you can hear a beep when Coredy R650 Ultra is docked onto the Charging Base. If not, contact the Coredy service center to repair or replace the Charging Base.

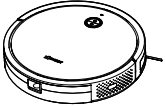
Problems	Solutions
Coredy R650 Ultra cannot return to the Charging Base.	<ul style="list-style-type: none"> Remove objects within 3 ft/1 m to the left and right side and within 6 ft/2 m of the front of the Charging Base. When Coredy R650 Ultra is in the vicinity of the Charging Base (distance within 26ft/8M), it returns more quickly. However, if the Charging Base is located far away (distance over 26ft/8M), Coredy R650 Ultra needs more time to return. Please be patient as it travels back. Clean the charging contact pins.
The rolling brush does not rotate.	<ul style="list-style-type: none"> Clean the rolling brush. Check if the rolling brush and brush guard have been installed properly.
Coredy R650 Ultra's movements or travel path are abnormal.	<ul style="list-style-type: none"> Clean the sensors carefully with a dry cloth. Restart Coredy R650 Ultra by turning the power switch off and on.

Specifications

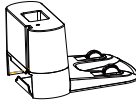
	Model	R650 Ultra
	Input	19 V  0.6 A
	Working Voltage	14.4V
	Rated Power	28W
	Battery Capacity	2600mAh
	Dustbin Capacity	500ml
	Charging Time	300-360mins
	Working Time	Approx. 120mins

	Model	C001
	Input	19 V  0.6 A
	Output	19 V  0.6 A

CONTACT US

 support@coredytech.com

 <http://shop.coredy.com>



(US) +1-800-999-8470

(UK) +44-808-134-9909

(DE) +49 800 000 9581

(AU) +61 39 917 5657

 @CoredyOfficial

 @CoredytechOfficial

 @coredylife