

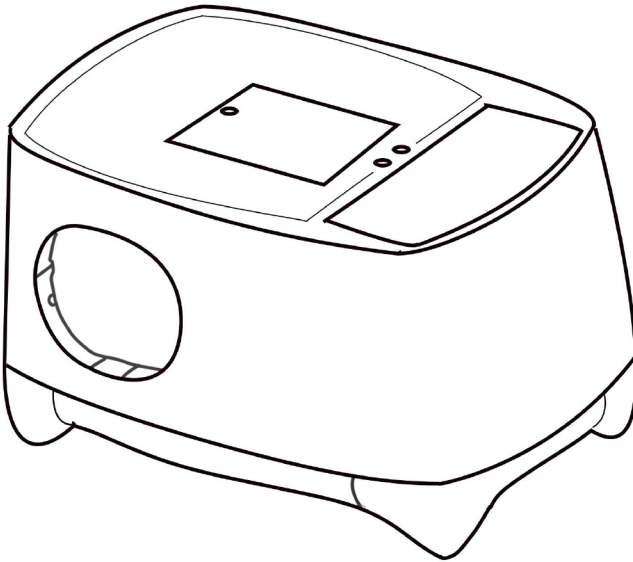

iKuddle



LOVE MORE • SMARTLY

iKuddle Smart Auto-Packing Litter Box

Instruction Manual

Please Read This Instruction Manual Before Use

Table of Contents

Components.....	2
iKuddle Specifications.....	3
Preparing Your iKuddle For Use.....	3
A. Important Instructions.....	3
B. Litter.....	3
C. Power and Installation.....	4
Control Panel.....	5
Button Lights and Functions.....	5
Light Indicators.....	6
App Connection.....	7
Self-Cleaning.....	8
Auto-Packing.....	8
Deodorizing System.....	8
Safety Sensors.....	8
Disassemble and Care.....	9
A. Changing Waste Bag Accessory and Air Filter.....	9
B. Changing the Litter and Cleaning the Litter Tray.....	9
C. Litter Rake Maintenance.....	10

iKuddle Components

iKuddle® Smart Auto-Packing Litter Box

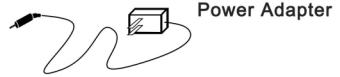
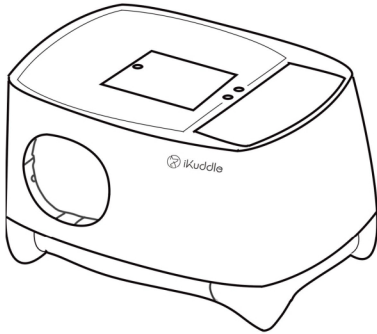

Power Adapter

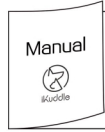

Instruction Manual



Waste Bag Accessory
(30 Bags / Set)



Carbon Filter

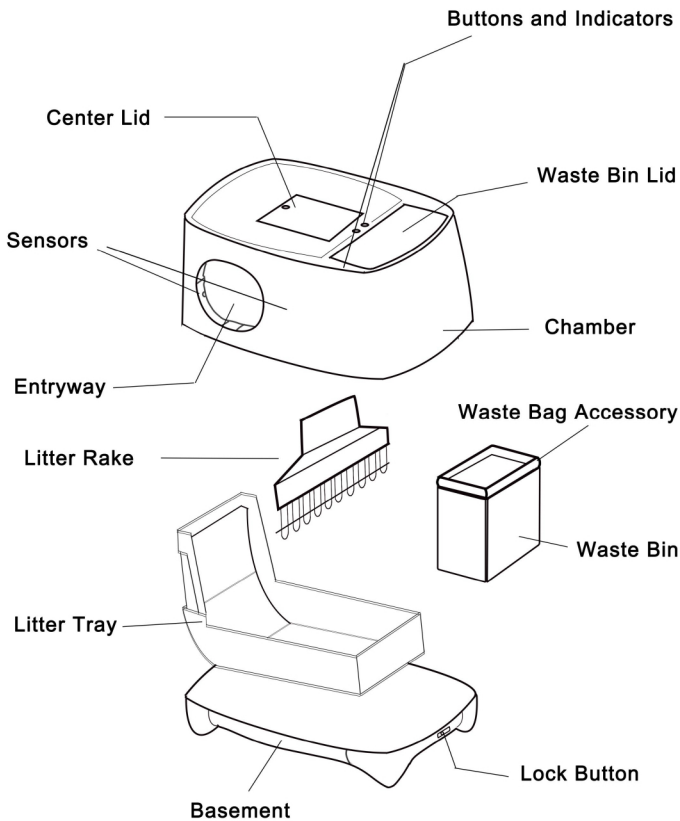

Specification	
Model No.	IK001
Dimensions	30" x 20.4" x 17.2"
Entryway	9.5" x 7.5"
Litter Tray	16.5" x 14" x 2.4"
Waste Bin	1.6 gal
Material	ABS

Preparing Your iKuddle For Use

A. Important Instructions

A1. Please read this guide thoroughly before using the **iKuddle Smart Auto-Packing Litter Box** and keep this Instruction Manual for future reference.

A2. Place the new **iKuddle Smart Auto-Packing Litter Box** in the same spot as your previous litter box.

A3. Make sure the **iKuddle Smart Auto-Packing Litter Box** is placed on a dry, firm, and hard surface that is leveled; avoiding heat and humidity.

A4. **iKuddle Smart Auto-Packing Litter Box** must be placed in an area with Wi-Fi coverage.

A5. Keep the top of the **iKuddle Smart Auto-Packing Litter Box** clear of all objects.

A6. We highly recommend cleaning the litter tray once every two weeks.

*Please contact info@ikuddle.com if you have any further questions.

B. Litter:

B1. High-quality, clay-based, hard-clumping litter is required for **iKuddle Smart Auto-Packing Litter Box**. Non-clumping, loose-clumping litters, or absorbent wood pellet litter is not recommended.

*Please contact info@ikuddle.com if you need additional clarification on suitable litters to use in your **iKuddle Smart Auto-Packing Litter Box**.

B2. Shift the lock located on the center lid to open the litter entry. Next, attach the litter rake to the **iKuddle Smart Auto-Packing Litter Box**.

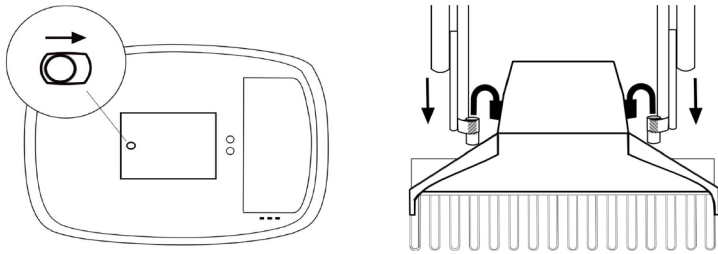

B3. Fill the chamber with litter through the center lid on top of the **iKuddle Smart Auto-Packing Litter Box**. In order to avoid over-filling, please ensure the litter stays under the max line when it is leveled.

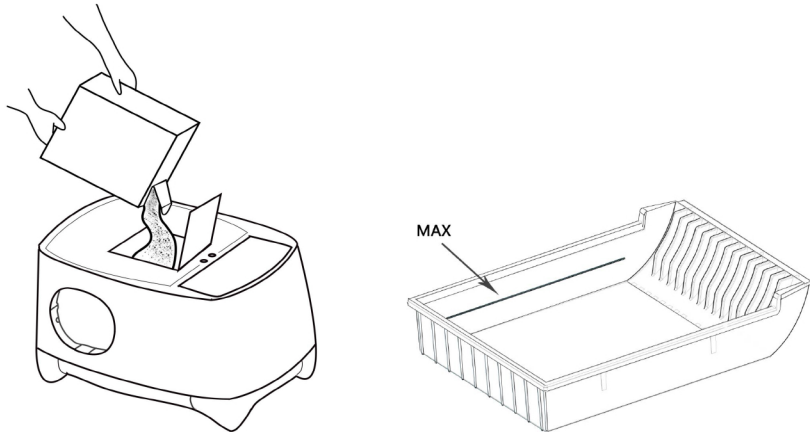

C. Power and Installation

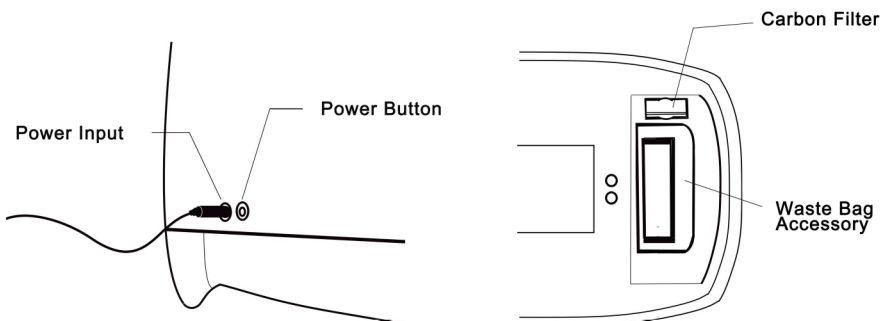

C1. Plug the power adapter into a standard outlet and insert the other end of the adapter into the power input socket located at the back of the litter box. Press the power button located beside the power input to turn on your **iKuddle Smart Auto-Packing Litter Box**.

C2. Press the **Button B** twice to unlock the control panel. Next, press **Button A** to open the waste bin lid.

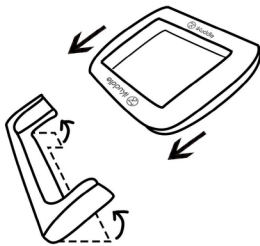

(Image 1)

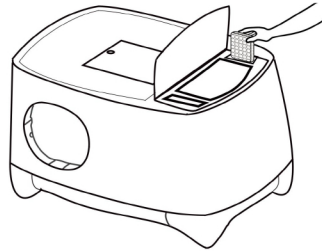

(Image 2)

C3. Slide the Waste Bags (Image 1) and the Air-Filter (Image 2) into the **iKuddle Smart Auto-Packing Litter Box**.

C4. Press **Button A** to close the waste bin lid.

*Waste Bags and the Air-Filters can be purchased at www.iKuddle.com or from authorized dealers.

Control Panel

Button Functions and Lights

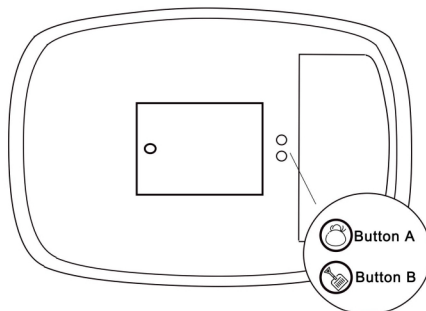

Button	Short Press	Long Hold	Double-Tap
Button A	Open/Close Waste Bin Lid	Auto-Packing	/
Button B	Self-Cleaning	WiFi Connection Setting	Unlock Control Panel

***Tip:** The panel lock is on by default, please double-tap Button B to unlock the panel before operating on the control panel.

Button Light Indicators

Button	Steady Green Light	Flashing Green Light	Quick Flashing Red Light	Red Light Flashing Slowly
Button A	/	Litter Box Operating	/	Operation Error
Button B	WiFi Connected	WiFi AP Mode	WiFi Attempting to Connect	No WiFi Connection

Light Indicators

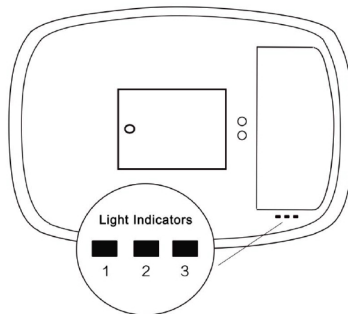

Light Indicator 1	Insufficient Power Supply
Light Indicator 2	Replace Air-Filter
Light Indicator 3	Replace Waste-Bag

App Connection

1. Search “iKuddle” on AppStore or Google Play to download the iKuddle App.
2. Turn on the **iKuddle Smart Auto-Packing Litter Box**, then open the iKuddle App and register an account following the in-app instructions (or login with your existing iKuddle account).
3. Double-tap **Button B** to unlock the control panel, then hold down **Button B** for 5 seconds. When **Button B**'s light starts to flash red, the **iKuddle Smart Auto-Packing Litter Box** is ready for connection via WiFi.
4. Follow the instructions on the iKuddle App to finish connecting your device to your **iKuddle Smart Auto-Packing Litter Box**.
5. The light on **Button B** will turn green to indicate that it has successfully connected.



Self-Cleaning

iKuddle Smart Auto-Packing Litter Box will begin self-cleaning 30 minutes after your cat exits the box (the default time is set at 30 minutes and can be adjusted in the iKuddle App to fit your personal preference). iKuddle will then separate the waste from the clean litter by scooping the clumps into the waste bag. The cleaning cycle can be initiated manually using the iKuddle App or by pressing **Button B** on the litter box. If at any time you would like to pause the self-cleaning process, please unlock the panel and press **Button A** or **Button B**.

Auto-Packing

When the waste bag is full, simply hold the **Button A** on the **iKuddle Smart Auto-Packing Litter Box** or the auto-packing button on the iKuddle App to pack and seal the Waste Bag. Once it's ready, the lid will automatically open. Once you have discarded the sealed bag, press **Button A** to close the waste bin lid and the **iKuddle Smart Auto-Packing Litter Box** will automatically place a new waste bag in the waste bin.

Warning: DO NOT open the trash bin lid while the auto-packing function is in operation.

Deodorizing System

The deodorizing system filters the air in the **iKuddle Smart Auto-Packing Litter Box**, keeping the air in your home smelling fresh. The deodorizing system starts operating at the same time as the self-cleaning cycle and deodorizes for 5 minutes. You can also manually activate the deodorizing system by pressing the button on the iKuddle App.

Safety Sensors

1. IR Sensor + Pyroelectricity

The Safety Sensors detect when your cat(s) enter and exit the box. If your cat hops back in during a cleaning, the **iKuddle Smart Auto-Packing Litter Box** pauses the cleaning cycle automatically and resumes operation 30 seconds after your cat exits the **iKuddle Smart Auto-Packing Litter Box**.

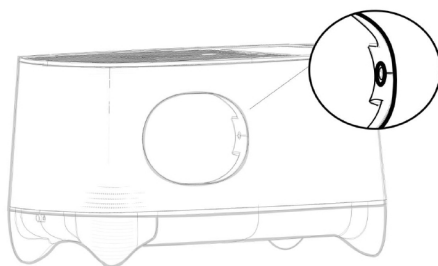

2. Anti-Jamming Protection System

If the cat litter shovel gets stuck while in operation, the anti-jamming protection system will be activated. Once the system has been activated, the light indicators will begin flashing red along with sounds to notify you. Manual removal of obstacles may be required.

Disassemble and Care

D. Changing Waste Bag Accessory and Air Filter

- D1. Double-tap **Button B** to unlock the control panel
- D2. Press Button A to open the waste bin lid.
- D3. Take out the accessory you would like to replace.
- D4. Repeat steps C3 and C4 above.
- D5. Reset the status of the accessories on the iKuddle App.

*Waste Bags and the Air-Filters can be purchased at www.iKuddle.com or from authorized dealers.

E. Changing the Litter and Cleaning the Litter Tray

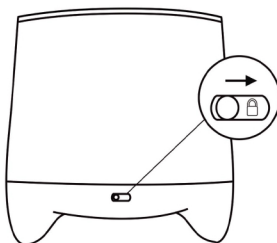

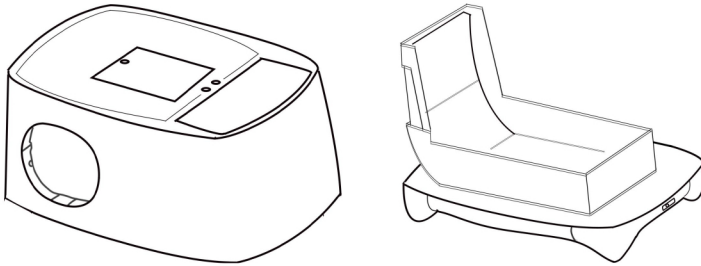

- E1. Turn off the power button and pull out the power adapter.
- E2. Shift the locks on both sides of the **iKuddle Smart Auto-Packing Litter Box** to unlock the chamber.
- E3. Vertically disassemble the chamber.
- E4. Disassemble the litter tray and clean thoroughly.
- E5. Wipe the **iKuddle Smart Auto-Packing Litter Box** dry and place the litter tray back.
- E6. Reassemble the chamber.
- E7. Shift the lock on both sides of the litter box to secure the chamber onto the basement.

F. Litter Rake Maintenance

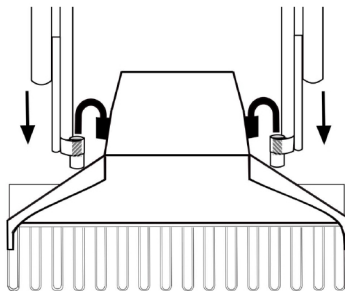

- F1. Repeat the steps E1 to E3.
- F2. Vertically pull up the rake to disassemble.
- F3. Thoroughly clean and dry the litter rake, then reinstall the litter rake by sliding it back into the two slots on the sides.
- F4. Repeat steps E6 and E7.

QUESTIONS OR COMMENTS
EMAIL US AT INFO@IKUDDLE.COM

MADE IN CHINA



iKuddle

iKuddle Inc.

www.ikuddle.com

2119 Sastre Ave,

South El Monte, CA 91733

Contact: info@ikuddle.com