

(Ver. 03/2022)

OWNER'S MANUAL

Direct Connect Under Sink Water Filtration System

DW10F/15F/20F



CONTENT

1. BEFORE INSTALLATION	01
2. PRODUCT INTRODUCTION	02
3.SAMPLE CONNECTION	03
4. INSTALLATION TIPS	03
5. INSTALLATION STEPS	04
6. REPLACEMENT FILTER	07
7. FILTER REPLACEMENT INSTRUCTION	07
8. MULTI-USAGE	08
9. PERFORMANCE DATA	08
10. FREQUENTLY ASKED QUESTIONS	09
11. LIMITED PRODUCT WARRANTY	09
12. WARRANTY REGISTRATION	10

If you have problems during the purchase or installation process, please contact our customer service.

 www.frizzlife.com

 support@frizzlife.com



FOLLOW US @Frizzlife

Receive first-hand promiton info and be the first one getting exclusive benefits.

Register to activate your warranty with Frizzlife.

- › Scan the QR code to register
- › Email us your order ID and full name at support@frizzlife.com



Find the Installation Video

- › Search “Frizzlife DW10F/DW15F/DW20F Installation” on www.youtube.com

1. BEFORE INSTALLATION

› Inspect Box

Please take out the system and all the components from the box. Inspect them carefully according to “Product Introduction”, and make sure nothing is missing or damaged during shipping. If any parts are cracked or broken, please do not proceed with installation, and contact Frizzlife for an exchange or diagnosis.

› Technical Parameters

Model No.	DW10F	DW15F	DW20F
Dimension	4.9×9.9×15 in	4.9×9.9×19 in	4.9×9.9×21 in
Replacement Filter	SED10R, CB10R	SED15R, CB15R	SED20R, CB20R
Replacement Period	3-6M, 12-18M	4-8M, 16-24M	6-12M, 24-36M
Flow Rate	1.5 GPM @ 60 psi		
Applicable Water Source	Municipal Water		
Operational Temp	Min.39°F,Max 100°F		
Working Pressure	Min.20psi, Max. 80psi		

› Precautions

- Do not use it with water that is microbiologically unsafe or of unknown quality without adequate disinfection.
- For cold water use only.
- Do not freeze the filter, as this case cause cracking and water leakage.
- Do not allow children under 3 years of age to have access to small parts during the installation of this product.
- Testing was performed under standard laboratory conditions, actual performance may vary.
- This installation must comply with all applicable state and local regulations.
- Please flush water for 15 minutes for the first time usage.

2. PRODUCT INTRODUCTION

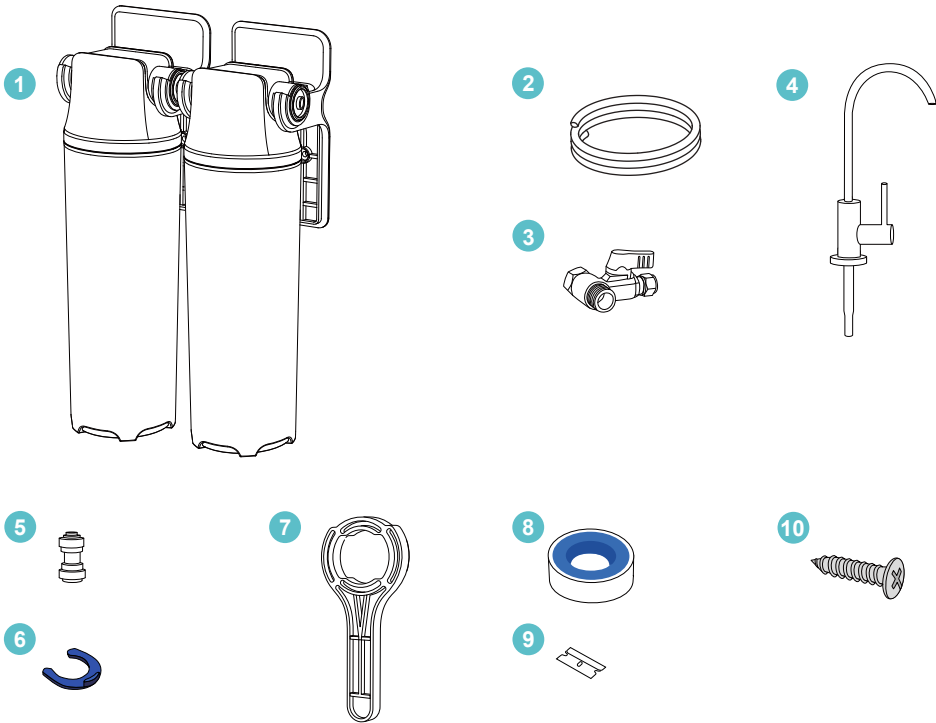

1 DW10F/DW15F/DW20F Filter System with Filters Loaded

2 1/4" Tubing

3 3-Way Feed Water Valve

4 Dedicated Faucet

5 1/4" Quick Fitting

6 Blue Clips

7 Wrench

8 Plumber Tape

9 Blade

10 Mounting Screws

3. SAMPLE CONNECTION

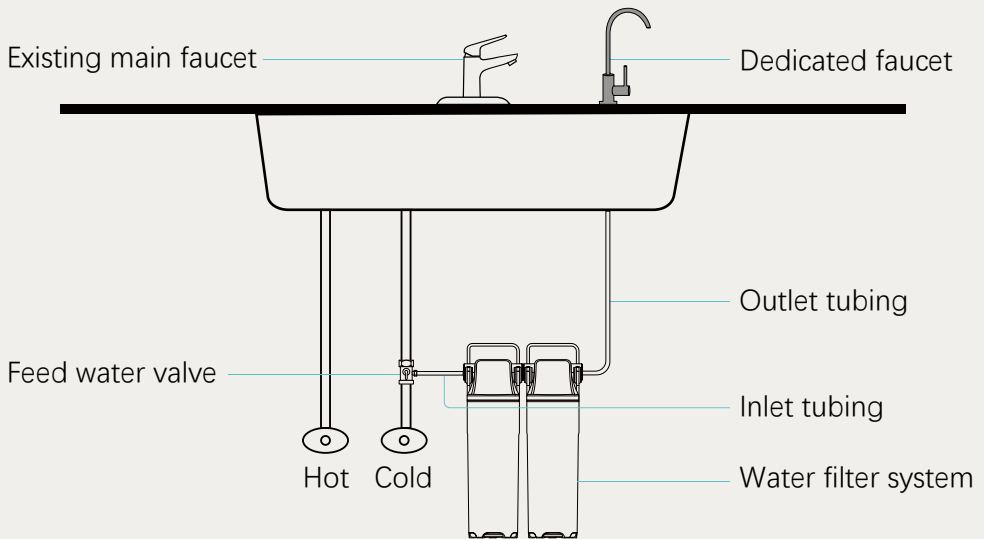

4. INSTALLATION TIPS

› How to cut the tubing?

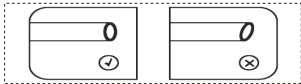

Please cut the tubing into two sections in proper length, make sure cut them squarely and cleanly.

› How to connect/disconnect the tubing?

To connect: Please push the tubing into the fitting and make sure it is fully inserted. Then put the blue lock clip on the fitting, it will lock the tubing in place.

To disconnect: Please remove the blue lock clip from the fitting, push in the lock sleeve, and then pull out the tube from the fitting.

Note: If the tubing is not fully inserted, water leakage may occur. Pulling out the tubing directly will damage the fitting, which may also cause water leakage.

1. Insert to seal the connection

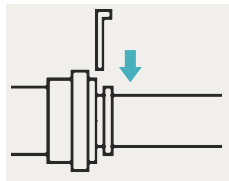
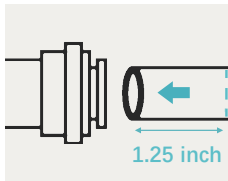

2. Remove to disconnect

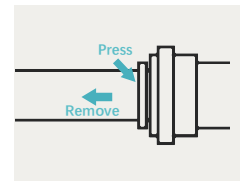
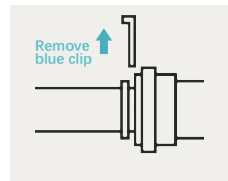

› How to drill a hole on my sink (Optional)

Note: Please remember to wear safety glasses to protect your eyes before proceeding.

Use a 1/2" metal bit to drill. The recommended diameter of the hole ranges from 1/2" to 1.2".

5. INSTALLATION STEPS

▲ Note: Please always use plumber tape on threaded connection parts to ensure a watertight seal.

› Step 1: Mount the system (onto a wooden plate)

1. Find the proper place to mount up the system.
2. Screw off the cartridges.
3. Mount up the filter heads using the provided screws.
4. Screw back the cartridges.

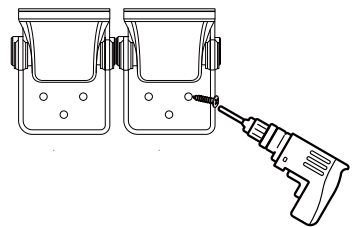

Note: Leave at least 2 inches higher than the ground for easier filter replacement.

› Step 2: Cut the tubing

1. Please cut the 1/4" tubing into two sections (1. inlet tubing 2. outlet tubing) in proper length based on your need.

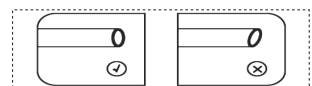

Please cut the tubing evenly, otherwise may result in water leakage.

› Step 3: Connect 3-way feed water valve

1. Load the inlet tubing through the nut.
2. Push and squeeze the tubing to the very end.
3. Use a wrench to tighten the nut, please do not over tighten.

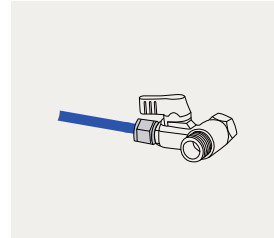
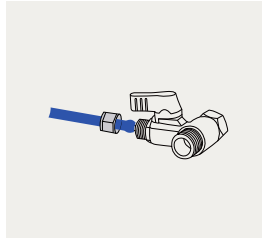
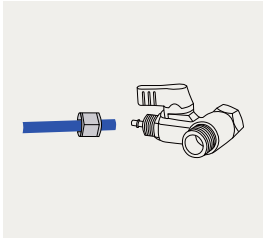

› Step 4: Connect the water supply (COLD WATER ONLY)

1. Shut off the water supply.
2. Remove the feed water hose from the angle valve.
3. Connect the 3-way feed water valve and make sure the rubber O ring is loaded.
4. Connect the feed water hose.
5. Valve installation complete.

Note: If your water valve is 1/2", please contact us to claim the 1/2" to 3/8" converter set.

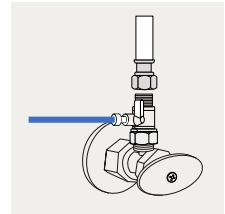
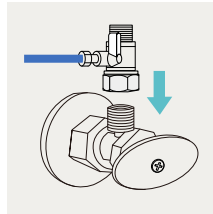
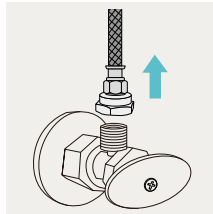
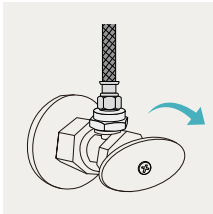

› Step 5: Connect the filter system

1. Remove the blue clip from the "Inlet" port, and connect the other end of inlet tubing to the "Inlet" port. Please make sure the tubing hits the bottom of the fitting.
2. Put back and lock the blue clip to seal the connection.
3. Connect the "Outlet" port with the outlet tubing in the same way.

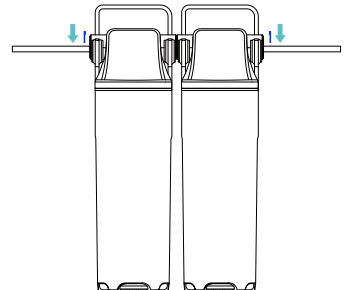

Note: Please make sure tubings are FULLY inserted into the ports, otherwise water leakage may occur.

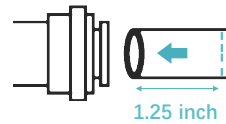

› Step 6: Install the faucet

1. Mount the faucet to your sink top
2. Connect the faucet with the 1/4" quick fitting
3. Connect the other end of outlet tubing from the "Outlet" port into the 1/4" quick fitting.

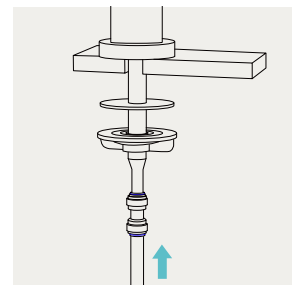
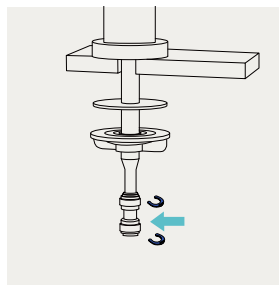
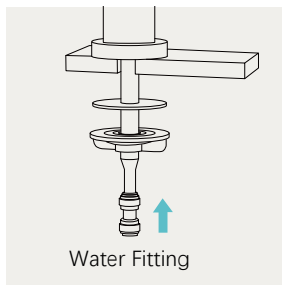
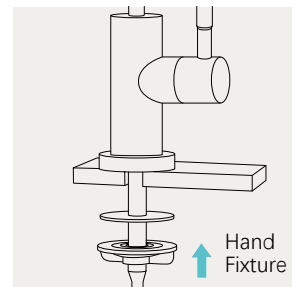
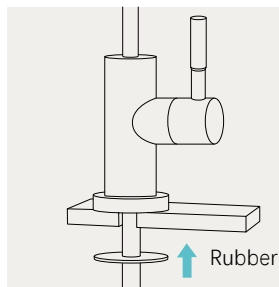
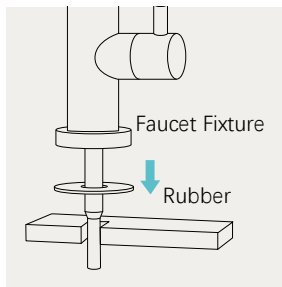

Note: If the thickness of your counter is over 1.9", please contact us at support@frizzlife.com to claim for longer stem.

Note: If your counter top or granite does not have an existing hole, please drill one (1/2") before proceeding.

› Step 7: Check for leaks

1. Turn on all the water supply and check for leaks.
2. Flush the system for 15 minutes before use.

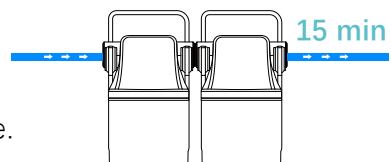

6. REPLACEMENT FILTER

The Frizzlife Under Sink Water Filter System requires care and cleaning after a period of time. It is recommended to change the cartridge according to corresponding time intervals in the table below. If the system has been working properly and the filtered water output is slowing down, it may be time to change the filter cartridge.

System Model No.	Replacement Filter No.	Filtration Capacity
DW10F	SED10R, CB10R	3-6M, 12-18M
DW15F	SED15R, CB15R	4-8M, 16-24M
DW20F	SED20R, CB20R	6-12M, 24-36M

⚠ Note: All the service life of the filter cartridge listed are based on actual laboratory test and the provided water. The actual service life of filter cartridge depends on source water quality and daily water usage.

7. FILTER REPLACEMENT INSTRUCTION

⚠ Note: With the Auto Shut off design of the system, you do not need to shut off the water supply when doing the replacement.

› Step 1: Twist the cartridge housing(s) clockwise

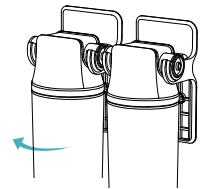

› Step 2: Using the wrench to unscrew the housing body

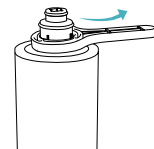

› Step 3: Take out the old cartridge and load with new one, then install back in the same way

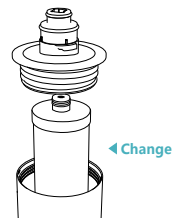

› Step 4: Flush the new cartridge for 15 minutes before starting to use

8. MULTI-USAGE

The DW-F Series system can be connected to your refrigerator / ice maker by utilizing Frizzlife **IMC-1 connection kit** (not included).

› Simply search “**Frizzlife IMC-1**” on Amazon or scan the QR code below to purchase.

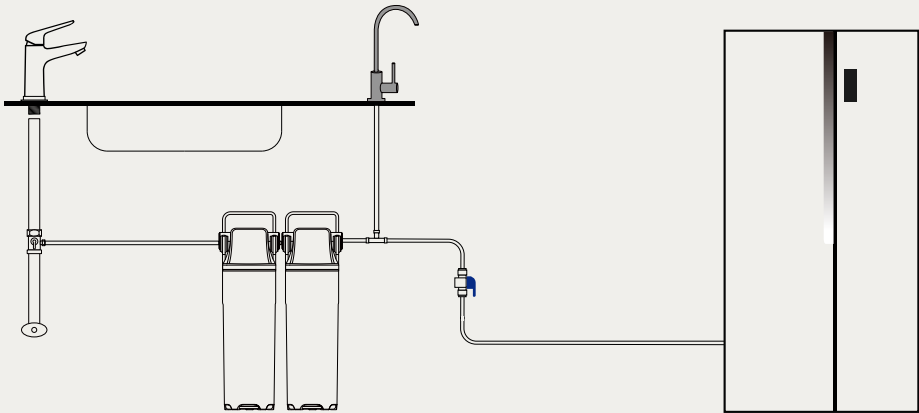

9. PERFORMANCE DATA

Substance	Influent challenge concentration (mg/L)	Maximum permissible product water concentration (mg/L)
Chlorine	2.0 mg/L \pm 10 %	\geq 50%
Particulate, Class I Particles 0.5 to $<$ 1 μ m	At least 10,000 particles/ml	\geq 85%
Lead	0.15 \pm 10 %	0.010
Cyst	Min. 50,000/L	99.95%

10. FREQUENTLY ASKED QUESTIONS

› Q: What should I do if water leaks after installation?

A: If once installed the system should leak, please shut off water supply firstly. If the leaking occurs at the thread, please wrap plumber tape on the external thread. Please contact Frizzlife customer service team for solutions if the water leakage persists.

› Q: Why TDS does not drop after filtration?

A: TDS is not a professional way to test the water quality. TDS means total dissolved solids, for example if you put a very little salt(NaCl) into the water and test the TDS, and you will find the result is dramatically high. Same thing, if your water is full of minerals, the TDS is very high too. The DW Series doesn't remove any of the minerals from water, but only stops harmful contaminants like heavy metals (Lead, Mercury, Cadmium) and over 90% of VOCs and Cysts, and it removes greatly the chlorine (99%) from water. Therefore, it is the reason why TDS you get is not that low as you expect.

11. LIMITED PRODUCT WARRANTY

DW10F/DW15F/DW20F Under Sink Water Filter System | Warrantor: FRIZZLIFE INC

› ONE YEAR LIMITED FRIZZLIFE WARRANTY

The Frizzlife DW10F/DW15F/DW20F Under Sink Water Filtration System are warranted to the original purchaser. To be free of defects in material and workmanship by FRIZZLIFE INC, FRIZZLIFE will replace or repair components of the unit that Frizzlife has deemed to be broken within the limits of the warranty without charge. The customer is not responsible for any freight involved with shipping the item back for inspection and shipment of replacement for items. Frizzlife is not liable for cost of removal, installation, transportation or any other charges in connection with a warranty claim.

Customer must register their systems with Frizzlife within **90** days of purchase in order to obtain a warranty. Warranty will discontinue after the unit is removed from the location where it was originally installed. Warranty begins on the date of delivery of product to the customer.

› Owner's Warranty Responsibility:

As a condition of this Limited Warranty, the owner must ensure that periodic maintenance of the system is performed as described in the literature enclosed with the system. Should your unit develop a defect or otherwise fail to perform in accordance with this warranty, you should contact the retailer from whom the product was originally purchased.

1. Frizzlife is not liable for anything that we deem as abuse of the units, including but not limited to, misuse of product outside of intended use, equipment modifications, unauthorized repairs, improper installation, damage from freezing, hot water, fire or other acts of God outside of Frizzlife control.

This warranty will be void if defects occur due to failure to observe the following conditions:

- | Incoming water to the the system cannot exceed 100°F.
 - | Do not use outdoors or in a location that is subjected to direct sunlight or freezing. This warranty will not be effective unless and until the Frizzlife is shown to have been used in accordance with the installation and maintenance instructions accompanying the product.
 - | The filter cartridges should be replaced in time according to the recommended replacement period.
 - | The plastic housings should be replaced every 18 months.
2. Filter Cartridges are considered as disposable items, thus are not covered by warranty.
 3. Customer is responsible for proper operation, which includes complete and continual leak inspection.
- | Most of the unit components are made of plastic and eventually can break or crack from stress.
 - | There are no other warranties which extend beyond what is described above.

12. WARRANTY REGISTRATION

150% EXTENDED WARRANTY

1. Email us you order ID and full name at support@frizzlife.com within 90 days.
2. Scan the QR code below to register



If you have any questions, any suggestions, or you need any assistance, please free to contact us anytime at support@frizzlife.com.

Your satisfaction is always our top priority!