



UL 2034

Email: support@x-sense.com



www.x-sense.com

# X-SENSE

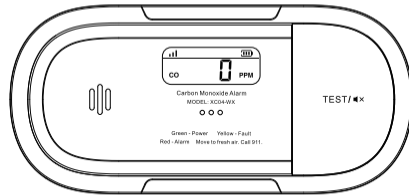

## User Manual

### Wi-Fi Carbon Monoxide Alarm **XC04-WX**

F.1.05.XC0401 V1.1

## English

This user manual contains important information regarding the installation and operation of your carbon monoxide alarm. Please take a few minutes to thoroughly read this manual which should be saved for future reference. If you are installing the carbon monoxide alarm for use by others, you must leave this manual—or a copy of it—with the end user.

## Introduction

This device is a battery-powered Wi-Fi carbon monoxide (CO) alarm. It is designed with an advanced electrochemical sensor and is for domestic use only. After the device is connected to the app, you can remotely use your smartphone to control the device, receive app push notifications, and make daily use more convenient. Please note that this device does not detect smoke, heat, flames or any hazardous gas other than carbon monoxide even though carbon monoxide can be generated by fire. For this reason you must install smoke alarms to provide early warning of fire and to protect you and your family from fire and its related hazards.

## ⚠ WARNING

- THE INSTALLATION OF THE APPARATUS SHOULD NOT BE USED AS A SUBSTITUTE FOR PROPER INSTALLATION, USE AND MAINTENANCE OF FUEL-BURNING APPLIANCES INCLUDING APPROPRIATE VENTILATION AND EXHAUST SYSTEMS.
- THIS APPARATUS IS TO BE INSTALLED BY A COMPETENT PERSON.
- IT IS NOT TESTED FOR USE IN A CARAVAN OR BOAT.

## Package Contents

- 1 × CO Alarm (Pre-installed Battery)
- 2 × Screws
- 2 × Anchor Plugs
- 1 × User Manual
- 1 × Carbon Monoxide Safety Sticker

## Product Features

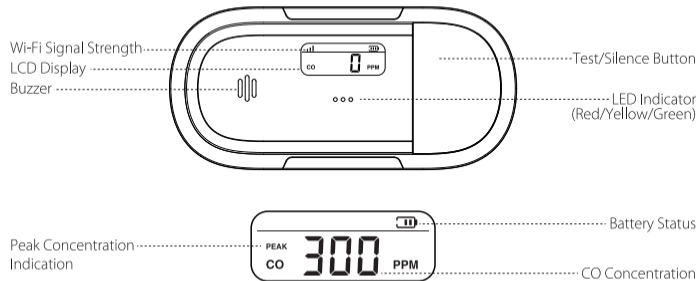

## Test/Silence Button

The test/silence button is used to test the unit's electronics and to silence the unit during an alarm.

Short press the test button and you will hear a short beep, indicating that the alarm has entered the test mode. A test push notification will be sent to your smartphone by the app. Please refer to the "Alarm Testing" section for further information. The alarm goes back to the standby mode after testing.

**NOTE:** After a test has begun, the alarm will sound and the LED indicator will flash red. This does not indicate that CO is present. If you press the test button during an alarm state, the unit will enter the silence mode.

## CO Alarm Levels

This X-Sense carbon monoxide alarm is programmed to sound an alarm at the following CO concentrations within the time periods listed:

**70 ppm for 60–240 minutes,  
150 ppm for 10–50 minutes,  
and 400 ppm for 4–15 minutes.**

When CO is detected and the alarm sounds, the CO concentration will be displayed on the LCD and a blue backlight will be lit. The LED indicator will flash red and the alarm will issue 4 short beeps, repeating the cycle every 5.8 seconds. An alarm push notification will be sent to your smartphone by the app.

## CO Concentration and Symptoms

The table below shows the effects of different levels of CO poisoning on the body:

Parts per Million (PPM)	Effects on Adults
100	Slight headache, nausea, fatigue (flu-like symptoms).
200	Dizziness and headache within 2–3 hours.
400	Nausea, frontal headache, drowsiness, confusion and rapid heart rate. Risk to life after over 3 hours of exposure.
800	Severe headaches, convulsions, vital organ failures. Death possible within 2–3 hours.

### ⚠ WARNING

THIS DEVICE IS DESIGNED TO PROTECT INDIVIDUALS FROM ACUTE EFFECTS OF CARBON MONOXIDE EXPOSURE. IT MAY NOT FULLY SAFEGUARD INDIVIDUALS WITH SPECIFIC MEDICAL CONDITIONS. IF IN DOUBT, CONSULT A MEDICAL PRACTITIONER.

## Low-Battery Warning

If the battery is low, the unit will chirp once, and the LED indicator will flash yellow every 60 seconds to indicate that the battery needs replacement. A low battery notification will be sent to your smartphone by the app.

If you press the test button when there is a low battery, the low battery signal will temporarily stop for 10 hours; if you press the test button again, the unit will enter test mode, and then standby mode.

## End-of-Life Indication and Hush Control

Once the maximum lifetime of the alarm (10 years) is reached, the alarm will beep 3 times and the LED indicator will flash yellow 3 times every 60 seconds. This end-of-life signal can be temporarily silenced for 22 hours by pressing the test button. An end-of-life push notification will be sent to your smartphone by the app.

This end-of-life silence feature can only be used for a total of 30 days. After 30 days, the end-of-life signal cannot be silenced. During this end-of-life silence period, your alarm will continue to monitor for CO and provide protection as usual.

To help identify the date to replace the alarm, write down the date of first operation on the dedicated label, located on the side of the alarm.

## Device Setup Within the App

### Sign Up



To download the app, search for **X-Sense Home Security** in the Apple App Store or Google Play Store, or simply scan the QR code. Create an account using a valid email address. If you already have an account, make sure it is updated to the latest version.

**Note:** Make sure your phone runs on *iOS 11 and above, or Android 8.0 and above.*

### Before connecting alarms, make sure that:

1. Know your Wi-Fi network name and password.
2. Make sure you are connecting alarms to a 2.4 GHz Wi-Fi network (incompatible with 5 GHz Wi-Fi network).
3. Make sure the Bluetooth on your phone is turned on.

## Activate the Device

This device is equipped with a battery insulating film to ensure it will not be powered on during transportation before it has shipped from the factory. When installing this product, you will need to pull out the film before powering on and activating the device.

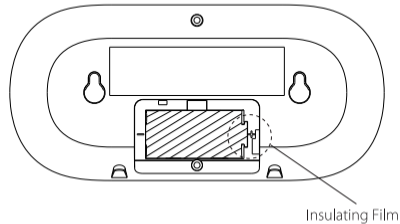

• 08 •

Before use, pull out the battery insulating film from the battery compartment to power on the device. After the device is turned on, the buzzer will beep once, the LCD backlight will light up, and the LED indicator will flash through 8 cycles (yellow/green/red). The device will then enter standby mode.

Follow the process below to open the battery compartment cover:

Hold the alarm with both hands and put your thumbs on both ends of the battery compartment cover. Then, push the cover upwards with some force to remove it.

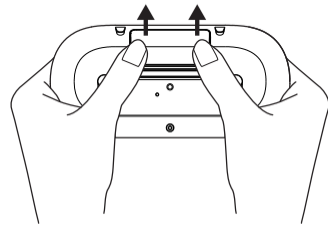

• 09 •

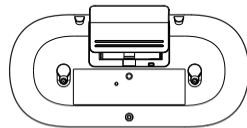

## Add a Carbon Monoxide Alarm

1. Tap "⊕" in the right top corner of the app homepage, select "Carbon Monoxide Alarms", then select "Wi-Fi CO Alarms" and tap "Next" to add a device.
2. Remove the insulating film to power up the alarm.
3. Enter a name for the alarm. Select the home you created or create a new home for the alarm, then select the room in which it is installed. If you create a new home, you will need to enter a name and select the country or region in which you live.
4. Press and hold the test/silence button on the alarm for 3 seconds until it flashes blue. Immediately tap **"Operation Confirmed"** before the light goes off; or else you need to repeat the step to make the LED indicator flash blue.

**NOTE:** *If your mobile phone finds two or more devices waiting to connect to the network, you need to tap to select the corresponding device you want to add.*

5. Connect to a 2.4 GHz Wi-Fi network and make sure you enter the correct password. Then, the alarm will enter the pairing process. Make sure the test/silence button (the LED indicator) is still flashing blue; or else you need to press it to make it flash blue again.
6. When finished, you will see the Wi-Fi CO alarm on the app's device list.

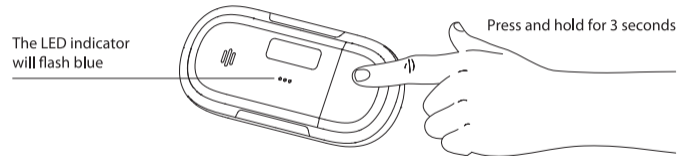

### NOTE:

- *If your router supports a dual band network with both 2.4 GHz and 5 GHz, please create separate SSIDs for the 2.4 GHz and 5 GHz channels. This device is only compatible with a 2.4 GHz Wi-Fi network.*
- *To promote successful Wi-Fi connection, make sure you place the alarm within the router range, and that you enter the correct password.*

## Set the Preferences for Your Mobile App

### Push Notifications

You can choose to receive app push notifications when any change is made to your system. It is highly recommended that you limit push notifications, as too many notifications can become redundant and load your phone, which can quickly become a nuisance. Furthermore, the more push notifications you allow, the more power your CO alarm will consume, which will reduce battery life.

### Record History

To access data or check device status, tap the History button on the bottom.

### Offline Notifications

Offline notifications are used to notify you if the alarm disconnects from the Wi-Fi. Note that this notification may not be sent instantly, as the alarm reports to the cloud service center at set intervals.

### CO Alarm Precaution

Dangerous CO concentration is detected, but has not reached the alarm status. The app will show a "CO Alarm Precaution" message, and an app push notification will be sent to your smartphone. Potential dangerous CO conditions exist.

## Where to Install

Ideally, a carbon monoxide alarm should be installed in every room containing a fuel-burning appliance, and one in every bedroom.

However, if the number of carbon monoxide alarms available is limited, the following guidelines should be considered when choosing the best places to install an alarm(s):

- If there is an appliance in a bedroom, a CO monitor should be installed.
- Install an alarm in rooms containing a flueless or open-flued appliance.
- Install an alarm where residents spend most of their time.
- In a studio apartment, a CO alarm should be placed as far away from the cooking appliances as possible, but close to where the person sleeps.
- If the appliance is in a room not normally used (such as a boiler room), the CO alarm should be placed just outside of this room so that the alarm can be heard more easily.

### 1. Installing a CO alarm in a room with a fuel-burning appliance (see Figure 1):

- If it is mounted on a wall, it should be installed at a height greater than the height of any door or window, but should still be at least 150 mm (5.9 inches) below the ceiling.



- The CO alarm should have a horizontal distance between 1 m (3.3 feet) and 3 m (10 feet) from any potential CO source.
- If there is a partition in the room, the CO alarm should be installed on the same side of the partition as the potential CO source.

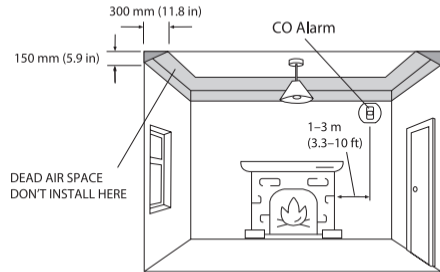

Figure 1: Installation in a room with a fuel-burning appliance

## 2. Installing the CO alarm in a bedroom or room without a fuel-burning appliance (see Figure 2):

- Mount the CO alarm relatively close to the breathing zone of the occupant.
- Install the alarm such that the LED indicator is viewable when the occupant is near the alarm.

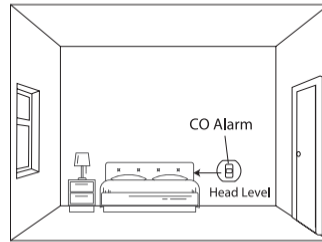

Figure 2: Installation in a bedroom or other room without a fuel-burning appliance (installed at head level)

**NOTE:** Due to the product's unique design and unfix installation, it is not recommended to install it on a ceiling, as it is prone to falling off and causing injuries to people.

## Locations to Avoid

### Important Note

Improper location can affect the sensitive electronic components in this alarm. To avoid causing damage to the unit, to provide optimum performance and to prevent unnecessary nuisance alarms, **do not locate CO alarms** in the following areas:

1. In garages or in any extremely dusty, dirty or greasy areas.
2. Where there is the possibility of smoke or fumes under normal operating circumstances.
3. In poorly ventilated kitchens, garages and furnace rooms. Keep the CO alarms at least 1.5 m (5 feet) from potential smoke or fume sources (e.g. stoves, furnaces, water heaters, space heaters) if possible.
4. In areas where a 1.5 m (5-foot) distance from a potential smoke or fume source is not possible. In modular, mobile or smaller houses, it is recommended the CO alarm be placed as far from any potential smoke or fume sources.
5. Within 1.5 m (5 feet) of any cooking appliance.
6. In extremely humid areas. This alarm should be at least 3 m (10 feet) from a bath or shower, sauna, humidifier, vaporizer, dishwasher, laundry room, utility room or other source of high humidity.

7. In areas where the temperature is colder than 4.4°C (40°F) or hotter than 37.8°C (100°F). For example, non-air-conditioned crawl spaces, unfinished attics, uninsulated or poorly insulated ceilings, porches and garages.
8. Where the air is turbulent, such as near ceiling fans, heat vents, air conditioner vents, fresh air return vents, or open windows. Excessive air flow may prevent any CO from reaching the sensors.
9. In direct sunlight.

## Installation Method

**NOTE:** Before installation, we recommend you test the Wi-Fi alarms in the rooms you wish to install them in to ensure they are within range of the Wi-Fi router that nothing is interfering with their communication.

### ⚠ WARNING

CONSTANT EXPOSURE TO HIGH OR LOW TEMPERATURES AND HIGH HUMIDITY MAY REDUCE BATTERY LIFE.

## Wall Mounting

1. Choose a suitable installation location by referring to the “Where to Install” section.
2. Remove the indication sticker from the packaging and refer to the hole locations on the sticker. Draw two screw holes according to the size and layout of the mounting holes on the back of the product. Drill the screw holes 30 mm (1.18 inches) deep using a  $\varnothing$  6.0 mm (1/4-inch) drill bit. Note that the distance between the center of the two holes is 74 mm (2.9 inches).

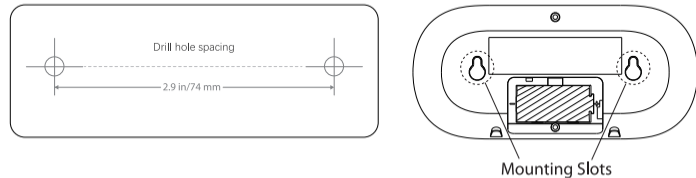

3. Insert the anchor plug into the screw hole and hammer it in until the head of the anchor plug is flush with the wall.
4. Use the two provided screws or 3.5 × 25 mm countersunk screws to screw into the two anchor plugs. Be sure to leave a 5 mm (1/5-inch) gap between the head of the anchor plugs and the screws, which will allow for easy device mounting.

5. Mount and lock the device onto the wall by aligning the two mounting slots on the back of the device with the screws on the wall.
6. Test the device by pushing the test button to make sure that the device is functioning properly.

## Installation on a Table

The base of the detector has two feet built into the design that allow it to stand freely on a flat surface.

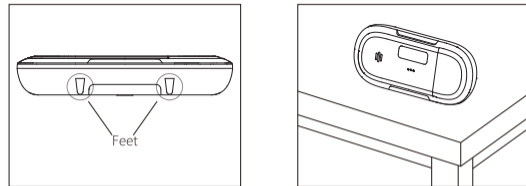

**NOTE:** When placing on a shelf, please adhere to the recommended placement as described in “Where to Install.”

## Alarm Testing

Be sure to test your CO alarms when you turn them on for the first time use. In addition to the weekly test you should perform, it is also recommended to test the alarm after returning from a long trip or vacation.

<b>Action</b>	Push the test/silence button.
<b>Device Response</b>	The device beeps 4 times twice, and the LED will flash red. The LCD will display "---," "PAS," the peak CO concentration recorded since the previous reset, and finally "0." This indicates that the device is functioning properly.
<b>App</b>	The app will show a test notification, and a push notification will be sent to your smartphone by the app.

**NOTE:** The test function accurately tests the alarm's CO sensing circuit without the need to test with CO. If your CO alarm fails to emit an audible test signal, refer to the troubleshooting guide at the end of this manual.

## Peak CO Concentration Memory and Reset

The peak CO concentration feature is helpful in identifying if there have been any dangerous CO readings since a peak CO concentration reset.

Each time you push the test button, the LCD displays the peak CO concentration recorded since the previous reset. The peak CO concentration will be displayed for 5 seconds, and then the device will enter standby mode. In the example, 300 ppm was the maximum CO concentration recorded since the unit was last reset.



**Peak CO Concentration Reset:** During the 5 seconds when the LCD displays the peak CO concentration, press and hold the test button for 3 seconds, the device will beep, the LED will flash green, and the peak CO concentration will be reset with LCD displaying "0."

**NOTE:** If the carbon monoxide concentration is lower than 30 ppm, it will not be recorded in the peak CO concentration.

## Alarm Mode

When the device detects CO, and the CO ppm reaches a certain level for a period of time, the unit will sound an alarm, beep 4 times every 5.8 seconds, and the LED will flash red. The app will show a “CO Alarm Triggered” notification, and an app push notification will be sent to your smartphone. The CO concentration is shown through the in-app message and push notifications. You can also check the CO concentration in the history section of the app.

When the carbon monoxide concentration drops below the alarm threshold, the alarm sound will stop, and the LED will flash green once every second for 5 seconds. Then, it will automatically enter standby mode. When the alarm ends, an app push notification will be sent to your smartphone.

## Silence Mode



If there is a false alarm, you can temporarily silence it by pressing the test/silence button on the device or in the app. You will receive an instant notification from the app telling you that the device has been temporarily silenced. The LED will flash red 4 times every 5.8 seconds to remind you that the alarm has been silenced. The alarm will automatically exit silence mode after 9 minutes.

During silence mode, if the carbon monoxide concentration is still greater than 70 ppm after 6 minutes, the device will be triggered again; if not, the device will automatically exit the silence mode after 9 minutes, and the LED will flash green 3 times continuously.







## LCD Display





While detecting CO, the LCD will display different indicators to inform you of the alarm status, as shown below:

Mode		LCD Display	LED Indicator	Audible Alarm	Remarks
Powering On	First-time use without connecting to the Wi-Fi.		Runs through 8 cycles (yellow/green/red) in sequence.	1 quick beep.	Make sure the battery insulating film is removed and the device is turned on.

	The battery is replaced and the device has connected to the Wi-Fi before.		The LED indicator flashes blue until the Wi-Fi connection is successful.	1 quick beep.	Make sure the battery is properly installed and the device is turned on.
<b>Standby Mode</b>			The LED indicator flashes green once every 60 seconds.	None.	None.
<b>Alarm Mode</b>			A CO concentration ranging from 30 to 999 ppm has been present for a certain time period. The blue backlight is lit, and the LED indicator flashes red 4 times every 5.8 seconds.	4 quick beeps repeating every 5.8 seconds.	Dangerous CO concentration is detected, and has reached the alarm status. The app will show a "CO Alarm Triggered" message, and an app push notification will be

					sent to your smartphone. Please refer to "What to Do When the CO Alarm Sounds".
			A CO concentration level ranging from 30 to 999 ppm has been detected, but for less than the allotted detection period. The LED indicator flashes green once every 60 seconds.	None.	Dangerous CO concentration is detected, but has not reached the alarm status. Potential dangerous CO conditions exist. Please search for the CO source first. Open nearby windows and doors, and immediately move to fresh air.
			The LED indicator flashes green once every second for 5 seconds.	None.	Alarm cancellation: when the CO concentration level drops below the alarm threshold, the alarm signal will stop. Then the device goes back to the standby mode.

<b>Test Mode</b>	  	2 sets of 4 red flashes.	2 sets of 4 quick beeps.	Peak CO level recorded since the previous reset.
<b>Peak CO Concentration Indication</b>		The LED indicator flashes green once.	1 beep.	
<b>Peak CO Concentration Reset</b>	 	The LED indicator flashes green once.	1 beep.	The peak CO concentration will be reset with LCD displaying "0."
<b>Silence Mode</b>		The LED indicator flashes red 4 times every 5.8 seconds.	None.	CO silence mode: After 9 minutes, the unit will exit silence mode.

	 	The LED indicator flashes yellow once every 60 seconds.	None.	Silence mode during low battery: After 10 hours, the unit will exit silence mode.
		The LED indicator flashes yellow 3 times every 60 seconds.	None.	Silence mode during the end of the cycle: After 22 hours, the unit will exit silence mode.
		The LED indicator flashes green 3 times.	None.	Exiting silence mode.
	<b>Low Battery</b>	 	Display alternates between "Lb" and the current CO level. The LED indicator flashes yellow once every 60 seconds.	1 quick beep every 60 seconds.

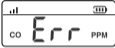
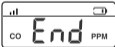
<b>Fault</b>		The LED indicator flashes yellow twice every 60 seconds.	2 beeps every 60 seconds.	Please clean your alarm and see if it is working normally. If "Err" continues to display, the unit has malfunctioned and must be replaced immediately.
<b>End of Life</b>		The LED indicator flashes yellow 3 times every 60 seconds.	3 quick beeps every 60 seconds.	Replace the unit immediately.

## Technical Specifications

<b>Power Supply</b>	CR123A (replaceable battery)
<b>Product Lifespan</b>	10 years
<b>Battery Life</b>	1 year
<b>Sensor Type</b>	Electrochemical

<b>Safety Standard</b>	UL 2034
<b>Operating Temperature</b>	4.4–37.8°C (40–100°F)
<b>Operating Relative Humidity</b>	10%–85% RH (non-condensing)
<b>Alarm Loudness</b>	≥ 85 dB at 3 m (10 ft) @ 3.2 ± 0.3 kHz pulsing alarm
<b>Silence Duration</b>	About 9 minutes
<b>App</b>	X-Sense Home Security (both Android and iOS supported)
<b>Wireless Frequency</b>	2.4 GHz (Incompatible with 5 GHz Wi-Fi network)
<b>Wireless Protocol</b>	IEEE 802.11b/g/n



## What to Do When the Alarm Sounds

1. Call emergency services as soon as possible.
2. Immediately move outside and make sure that everyone inside the house has evacuated the area or has access to fresh air. Do not re-enter the house until it has been aired out and your alarm remains under normal condition. If it is not possible to move outside, stay close to an open door/window until emergency service responders arrive.
3. After following steps 1–2 above, if your alarm reactivates within a 24 hour period, repeat steps 1–2 and call a qualified appliance technician to investigate sources of CO from fuel-burning equipment and appliances, and inspect for proper operation of this equipment.
4. If problems are identified during this inspection, have the equipment serviced immediately. Note any combustion equipment that has not been inspected by the technician and consult the manufacturer's instructions, or contact the manufacturers directly for more information about CO safety and this equipment. Make sure that motor vehicles are not, and have not been, operating in an attached garage or adjacent to the residence.

## Maintenance

To keep your alarm in good working order, you should adhere to the following steps.

1. Test the alarm once a week by pressing the test/silence button.
2. Vacuum the alarm cover once a month to remove any accumulated dust.
3. Never use detergents or solvents to clean the alarm. Chemicals can permanently damage or temporarily contaminate the sensor.
4. Avoid spraying air fresheners, hair spray, paint or other aerosols near the alarm.
5. Do not paint the unit. Paint may clog the openings to the sensing chamber and prevent the unit from operating properly.

### **▲ WARNING**

**DO NOT TAMPER WITH THE APPARATUS, AS THERE IS A RISK OF ELECTRIC SHOCK OR MALFUNCTION.**

## Battery Replacement

Remove the old battery and replace with a CR123A battery when the LCD displays the "Lb" message and the LED indicator flashes yellow once every 60 seconds with the buzzer chirping.

When the battery is replaced and the device is turned on, the alarm will beep once while the LED flashes red. Then, the LED indicator will begin flashing blue until the Wi-Fi connection is successful. If the LED indicator flashes for 2 minutes and then stops, this indicates the Wi-Fi connection has failed.

**NOTE:** Rechargeable batteries are not recommended for use with this device.

## Limitations of CO Alarms

1. CO alarms may not wake up all individuals. If children or others do not readily awaken to the sound of the CO alarm, or if there are infants or family members with mobility limitations, make sure that someone assists them in the event of an emergency.
2. This CO alarm will not sense carbon monoxide that does not reach the sensor. This CO alarm will only detect CO that reaches the sensor. CO may be present in other areas. Doors or other obstructions may affect the rate at which CO reaches the CO alarm. For this reason, if bedroom doors are usually closed at night, it is recommended that you install a CO alarm in each bedroom and in the hallway between them.
3. CO alarms may not sense CO on another level of the house. For example, a CO alarm on the second level, near the bedrooms, may not sense CO in the basement. For this reason, one CO alarm may not give an adequate warning. Complete coverage is recommended by placing CO alarms on each level of the house.
4. CO alarms may not be heard. The alarm buzzer noise level is over 85 dB at a distance of 3 m (10 feet). However, if the CO alarm is installed outside the bedroom, it may not awaken a sound sleeper or one who has recently used drugs or has been drinking alcohol. This is especially true if the door is closed or only partially open. Even persons who are awake may not hear the alarm horn if the sound is blocked by distance or closed doors. Noise from traffic, stereos, radios, televisions, air conditioners, or other appliances may even prevent alert persons from hearing the alarm horn. This CO alarm is not intended for people who are hearing impaired.

5. CO alarms are not a substitute for a smoke alarm. Although fire is a source of carbon monoxide, this CO alarm does not sense smoke or fire. This CO alarm senses CO that may be escaping unnoticed from malfunctioning furnaces, appliances, or other possible sources of incomplete combustion. The installation of a smoke alarm is required for an early warning of fire.
6. CO alarms are not a substitute for life insurance. Though these CO alarms warn against increasing CO levels, we do not warrant or imply in any way that they will protect lives from CO poisoning. Homeowners and renters must still insure their lives.
7. CO alarms have a limited life. Although the CO alarm and all of its parts have passed many stringent tests and are designed to be as reliable as possible, any of these parts could fail at any time. Therefore, you are strongly recommended to test your CO alarm weekly.
8. CO alarms are not foolproof. Like all other electronic devices, CO alarms have limitations. They can only detect CO that reaches their sensors. They may not give early warning of rising CO levels if the CO is coming from a remote part of the house, or is at some distance from the CO alarm.

## Troubleshooting

PROBLEM	SOLUTION
Your alarm does not sound during testing.	<ul style="list-style-type: none"><li>· Please ensure the batteries are properly installed in the alarm.</li><li>· Make sure you push the test/silence button firmly.</li></ul>
Device failed to connect to the network.	<ul style="list-style-type: none"><li>· Make sure the Bluetooth on your phone is turned on when you connect the device to the network. Read the operation instructions in this manual carefully.</li><li>· Make sure you have a 2.4 GHz Wi-Fi network.</li></ul>
When a CO alarm occurs or the device is tested, there are no app push notifications.	<ul style="list-style-type: none"><li>· Turn on the push notification permission on the phone.</li><li>· Check if the device is offline and make sure your network is in good condition.</li></ul>
The LED flashes yellow once every 60 seconds with 1 beep.	The battery is low. <b>Replace the battery immediately.</b>
The LED flashes yellow twice every 60 seconds with 2 beeps.	The alarm is malfunctioning. Please clean your alarm and see if it is working normally. If not, <b>replace the device immediately.</b>

The LED flashes yellow 3 times every 60 seconds with 3 beeps.

The maximum lifetime (10 years) is reached. **Replace the alarm immediately.** If immediate replacement is not possible, you may push the test/silence button once to silence for 22 hours.

## Environmental Protection

Waste electrical products should not be disposed of with household waste. Please recycle where facilities exist. Check with Local Authority or retailer for recycling advice.



## Manufacturer and Service Information

X-Sense Innovations Co., Ltd.

Address: B4-503, Kexing Science Park, 15 Keyuan Road, Shenzhen, 518057, CHINA

Email: support@x-sense.com