



INSTALLATION INSTRUCTIONS

**5INCH OVAL BEND SIDEBAR
2019-25 DODGE RAM 1500 CREW CAB
(Excl. 2019-2024 Ram 1500 Classic)
PART# 5S-19D1012BN**

TRUCK ACCESSORIES COMPANY

**5INCH OVAL BEND SIDEBAR
2019-2025 DODGE RAM 1500 CREW CAB**

PARTS LIST:

1	Driver/Left side 5inch Oval Bent End Sidebar	12	8mm x 25mm Combo Hex Bolts
1	Passenger/Right side 5inch Oval Bent End Sidebar	8	8mm x 25mm Hex Bolts
4	Front/Rear upper support brackets	20	8mm x 24mm OD x 2mm Flat Washers
4	Front/Rear lower mounting brackets	16	8mm x 16mm OD x 1.6mm Flat Washers
2	Center Mounting Brackets	28	8mm Nylon Lock Nuts
2	Support Brackets		

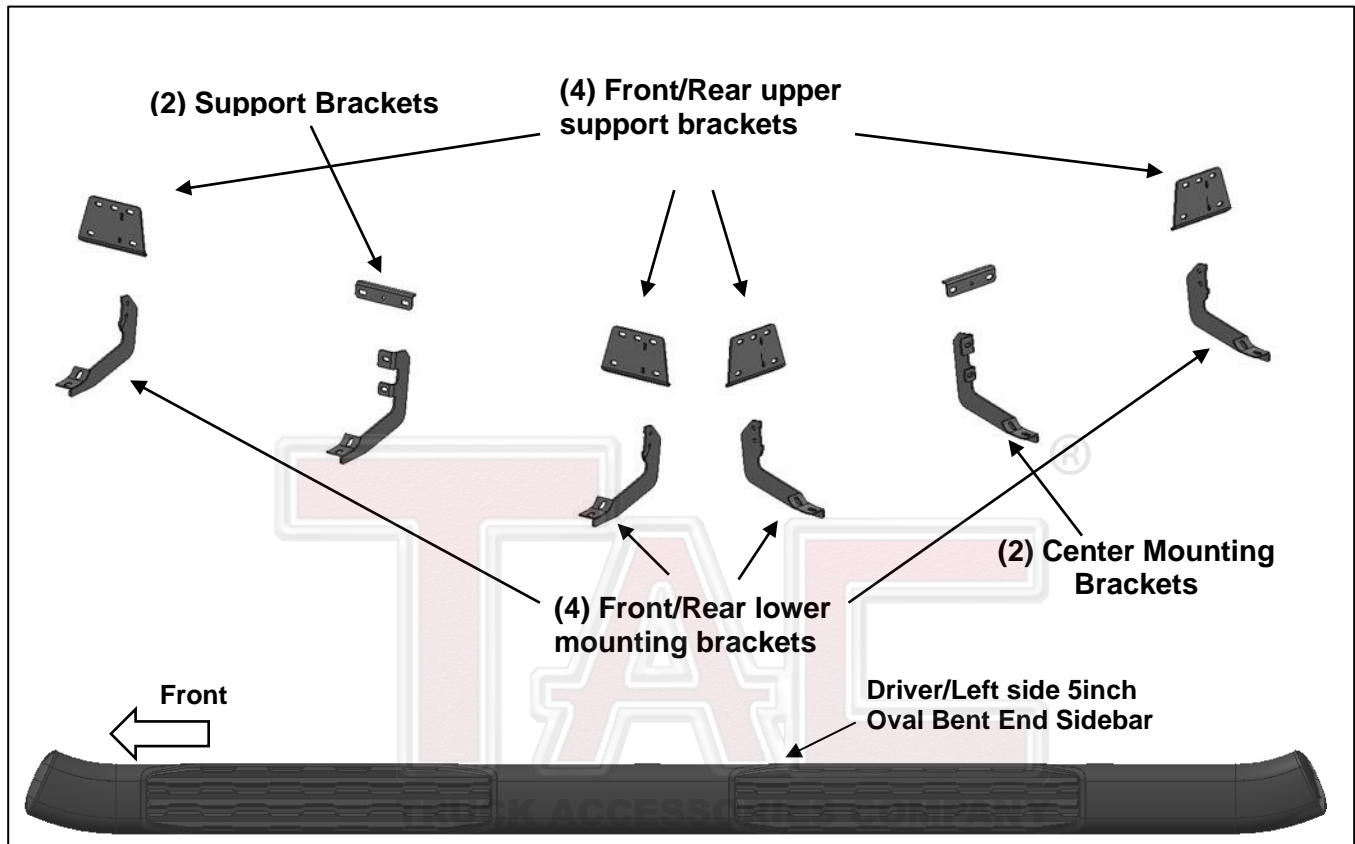

PROCEDURE:

- 1. REMOVE CONTENTS FROM BOX. VERIFY ALL PARTS ARE PRESENT. READ INSTRUCTIONS CAREFULLY BEFORE STARTING INSTALLATION. USE WIRE BRUSH TO CLEAN MOUNTING STUDS OF PAINT AND DEBRIS.**
- Start the installation under the Driver side of the vehicle. Locate the front (3) factory studs along the inner side of the body panel, **(Figure 1)**.
- Select (1) Front/Rear upper support bracket. Attach the Mounting Bracket to the (3) factory studs with (3) 8mm Flat Washers and (3) 8mm Nylon Lock Nuts, **(Figure 2)**. Leave hardware loose at this time.
- Next, attach (1) Front/Rear upper support bracket to the welded plate on the back of the Front/Rear lower mounting Bracket with (2) 8mm Nylon Lock Nuts, (4) 8mm Flat Washers and (2) 8mm Hex Bolts, **(Figure 3)**.
- Locate the center (3) factory studs along the inner side of the body panel, **(Figure 4)**.
- Select (1) Support Bracket. Attach the Support Bracket to the (2) factory studs with (2) 8mm Flat Washers and (2) 8mm Nylon Lock Nuts, **(Figure 5)**.
- Then attach (1) Center Mounting Bracket to the upper factory mounting stud and support bracket with (2) 8mm Flat Washers and (2) 8mm Nylon Lock Nuts, **(Figure 6)**.
- Repeat **Steps 2—4** to attach the remaining (1) Front/Rear upper support bracket and (1) Front/Rear lower mounting bracket to the rear mounting locations along the body panel, **(Figures 7)**.
- Attach the (1) Driver/Left side Oval Bent End Sidebar to the (3) Mounting Brackets with (6) 8mm Combo Hex Bolts, **(Figure 8)**. Do not tighten hardware.

**5INCH OVAL BEND SIDEBAR
2019-2025 DODGE RAM 1500 CREW CAB**

10. Level and adjust the Side Bar as necessary and fully tighten all hardware.
11. Repeat **Steps 1—10** to attach the Passenger/Right side Oval Bent End Side Bar to the vehicle.
12. Do periodic inspections to the installation to make sure that all hardware is secure and tight.

To protect your investment; Do not use any type of polish or wax that may contain abrasives that could damage the finish. Mild soap may be used also to clean the Side Bar.

Driver/Left Side Installation Pictured

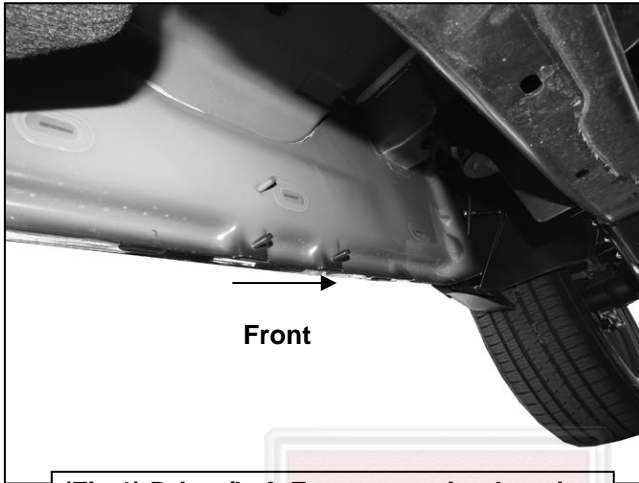

(Fig 1) Driver/Left Front mounting location

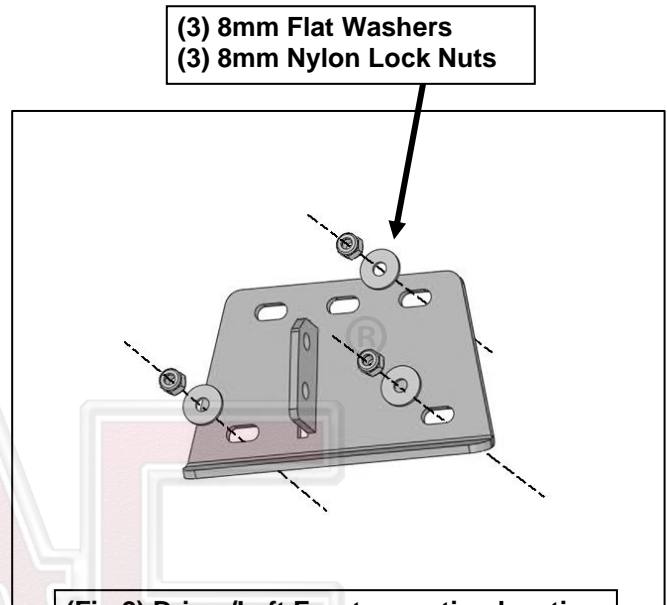

(Fig 2) Driver/Left Front mounting location

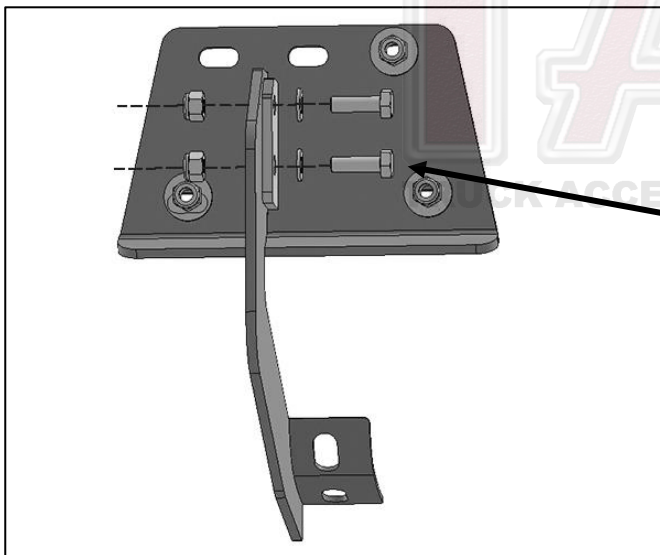

(Fig 3) Driver/Left Front mounting location

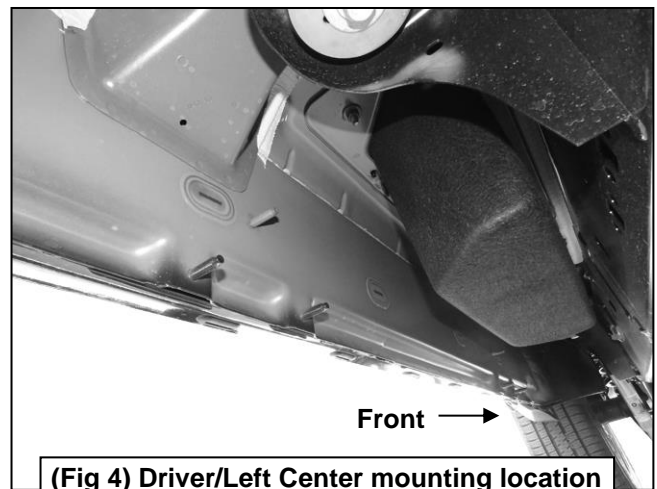

(Fig 4) Driver/Left Center mounting location

Driver/Left Side Installation Pictured

(2) 8mm Flat Washers
(2) 8mm Nylon Lock Nuts

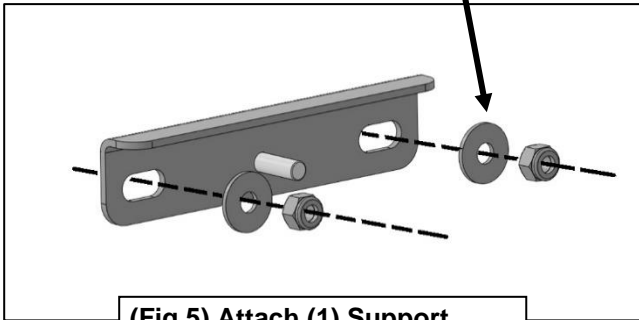

(Fig 5) Attach (1) Support Bracket to the threaded studs

(2) 8mm Flat Washers
(2) 8mm Nylon Lock Nuts

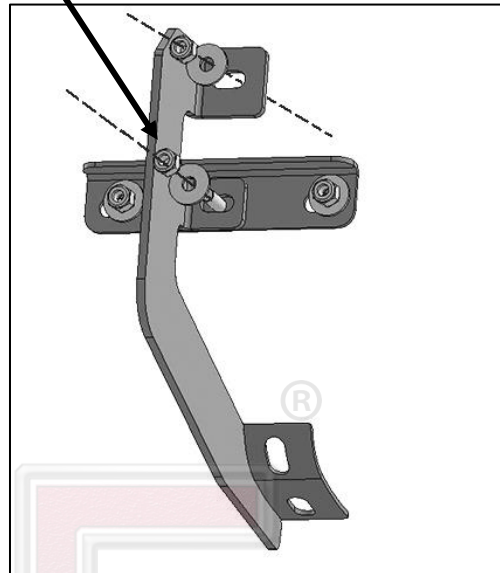

(Fig 6) Attach Mounting Bracket to the upper mounting stud and Support Bracket

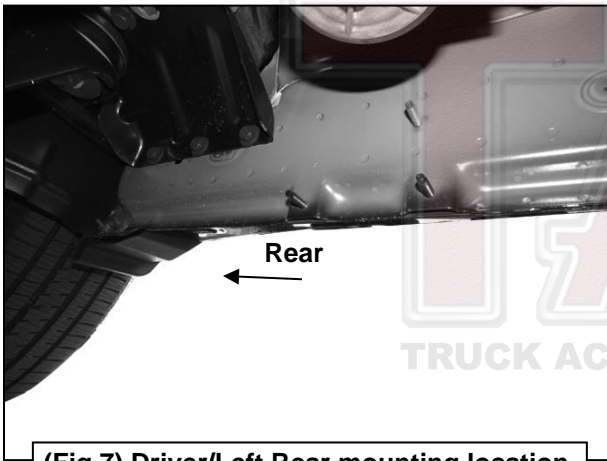

(Fig 7) Driver/Left Rear mounting location

(2) 8mm Combo Hex Bolts

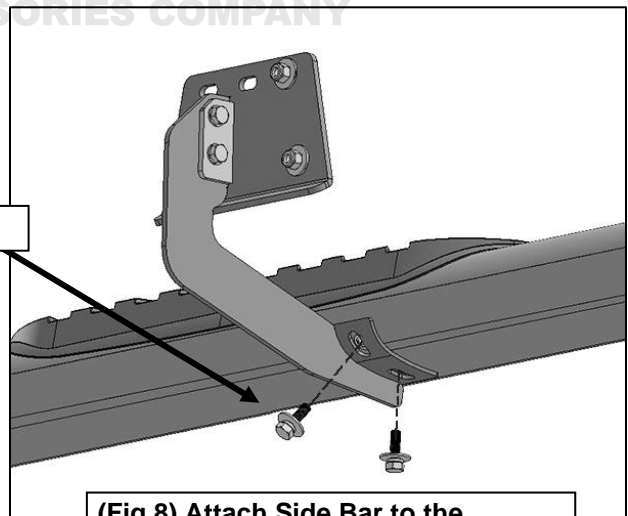

(Fig 8) Attach Side Bar to the Mounting Brackets