



INSTALLATION INSTRUCTIONS

PNC SIDEBARS

2019-2023 DODGE RAM 1500 QUAD CAB

(EXCLUDING 2019-2023 RAM 1500 CLASSIC)

PART# 40-23800T

PARTS LIST:

1	Driver/left side PNC Sidebar	12	8-1.25mm x 25mm Combo Hex Bolts
1	Passenger/right side PNC Sidebar	18	8mm x 24mm x 2mm Flat Washers
6	Mounting Brackets	18	8-1.25mm Nylon Lock Nuts

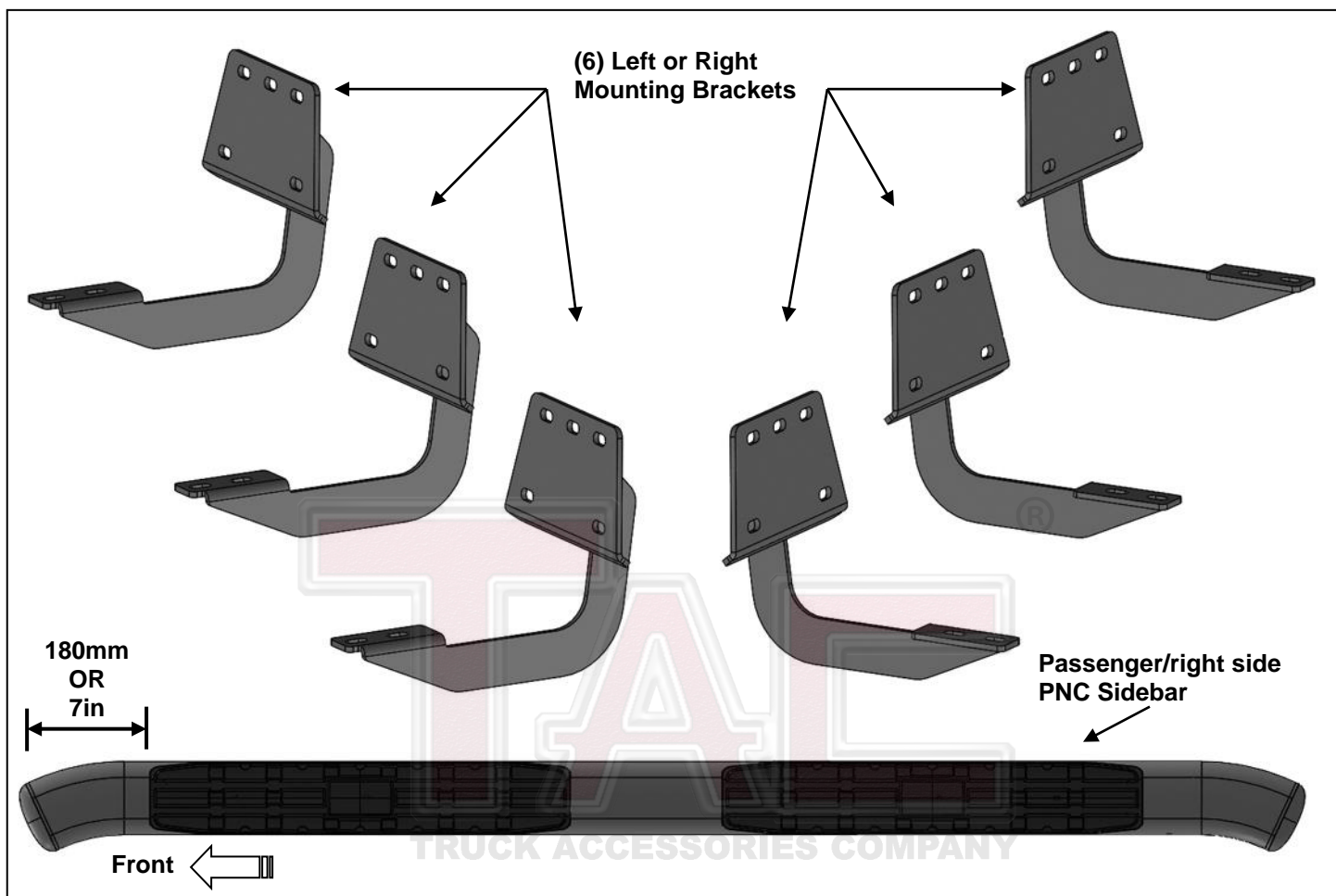

PROCEDURE:

REMOVE CONTENTS FROM BOX. VERIFY ALL PARTS ARE PRESENT. READ INSTRUCTIONS CAREFULLY BEFORE STARTING INSTALLATION. ASSISTANCE IS RECOMMENDED.

1. Start the installation under the passenger side of the vehicle. Locate the front (3) factory studs along the inner side of the body panel, **(Figure 1)**. **NOTE:** Use a wire brush or die to remove paint buildup on the threaded studs.
2. Select (1) Mounting Bracket. **NOTE:** All (6) Brackets are universal and will fit left or right side. Attach the Mounting Bracket to the (3) factory studs with (3) 8mm Flat Washers and (3) 8mm Nylon Lock Nuts, **(Figure 2)**. Leave brackets loose at this time.
3. Repeat **Steps 1 & 2** to install the Universal Brackets in the center and rear mounting locations along the body panel, **(Figures 3 & 4)**.
4. Carefully unwrap and select the Passenger/right Sidebar. Use the illustration above to help identify the correct Sidebar. **NOTE:** The front stepping pad is closer to the front end of the Sidebar. Place the Sidebar on top of the Brackets. **IMPORTANT:** Do not slide, (front to back), the Sidebar on the Brackets or damage to the finish on the Sidebar may result.
5. Attach the Sidebar to the Brackets with (6) 8mm Combo Hex Bolts, **(Figures 5 — 7)**. Do not tighten hardware at this time.

6. Level and adjust the Sidebar as necessary and fully tighten all hardware.
7. Repeat **Steps 1—6** for Driver/left Sidebar installation.
8. Do periodic inspections to the installation to make sure that all hardware is secure and tight.

To protect your investment, wax this product after installing. Regular waxing is recommended to add a protective layer over the finish. Do not use any type of polish or wax that may contain abrasives that could damage the finish. Mild soap may be used also to clean the Sidebar.

Passenger/right Side Installation Pictured

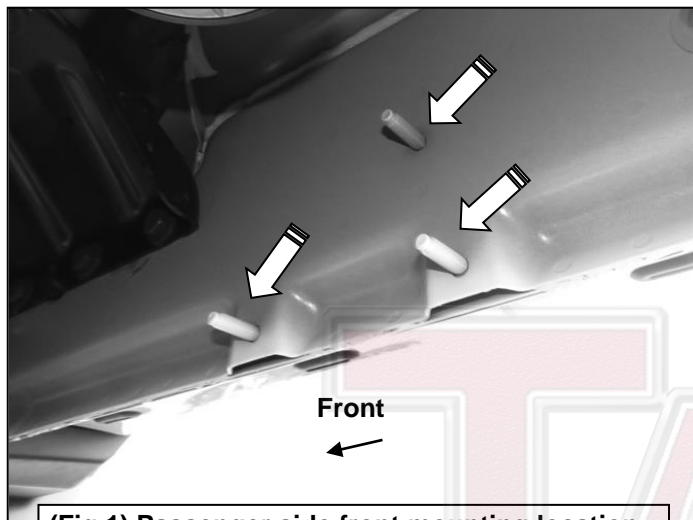

(Fig 1) Passenger side front mounting location

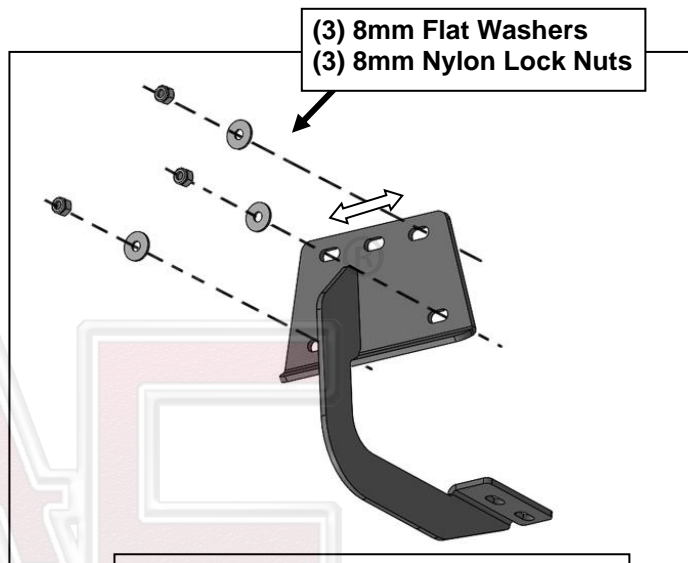

(Fig 2) Attach Bracket to the (3) studs

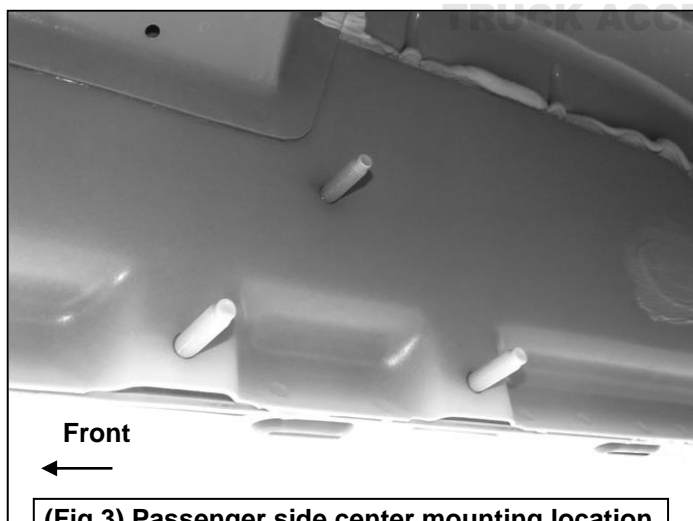

(Fig 3) Passenger side center mounting location

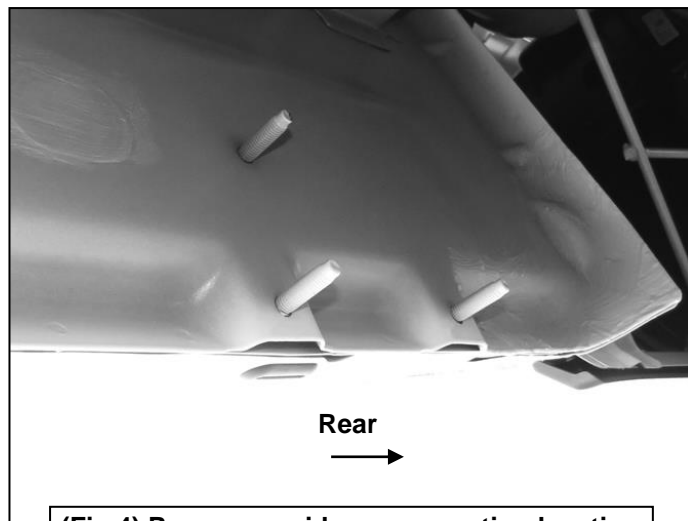

(Fig 4) Passenger side rear mounting location

Passenger/right Side Installation Pictured

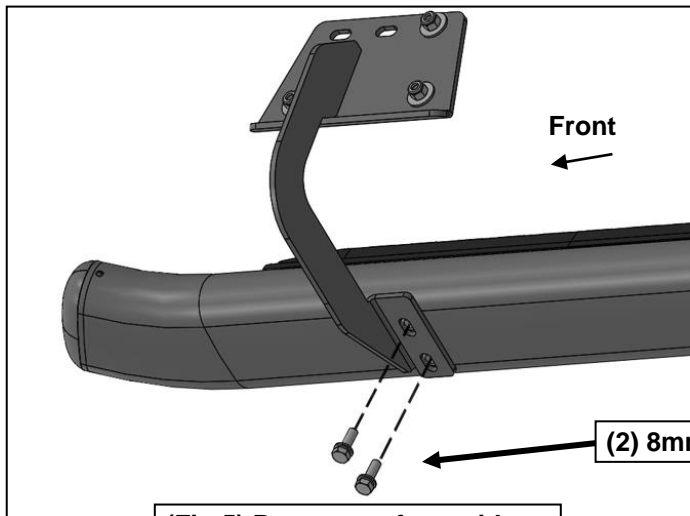

(Fig 5) Passenger front side Bracket attached to Sidebar

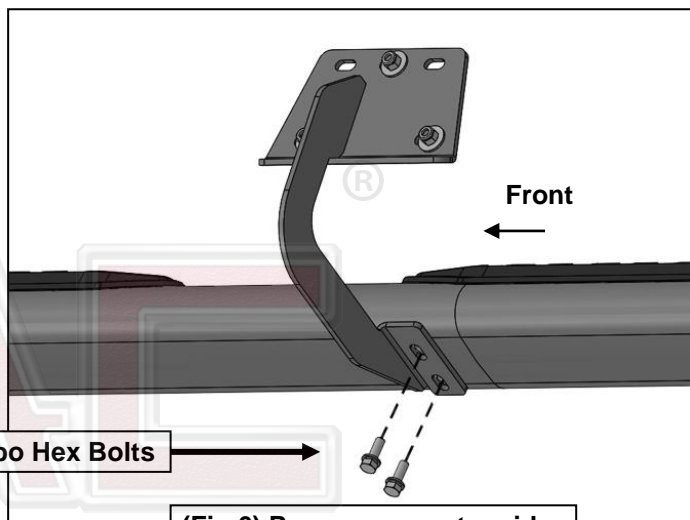

(Fig 6) Passenger center side Bracket attached to Sidebar

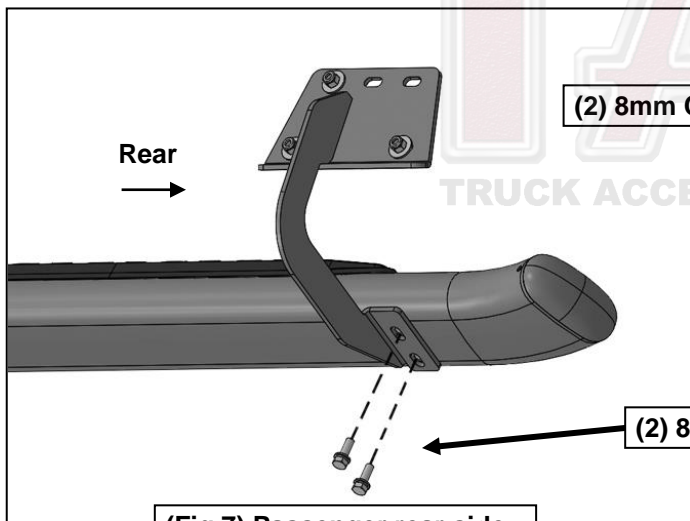

(Fig 7) Passenger rear side Bracket attached to Sidebar